

Assembly Instruction

Decorate your home, Brighten wonderful life

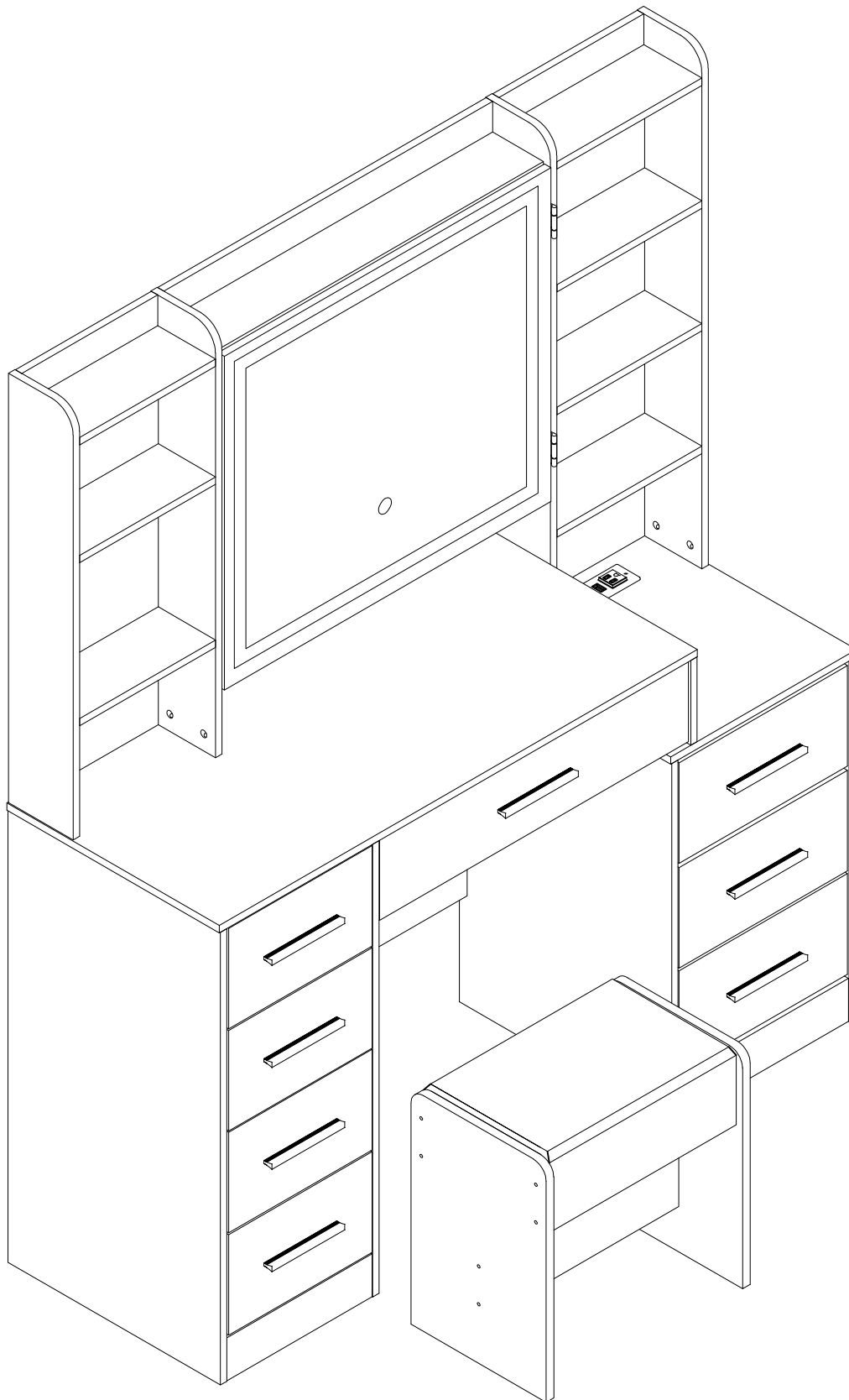

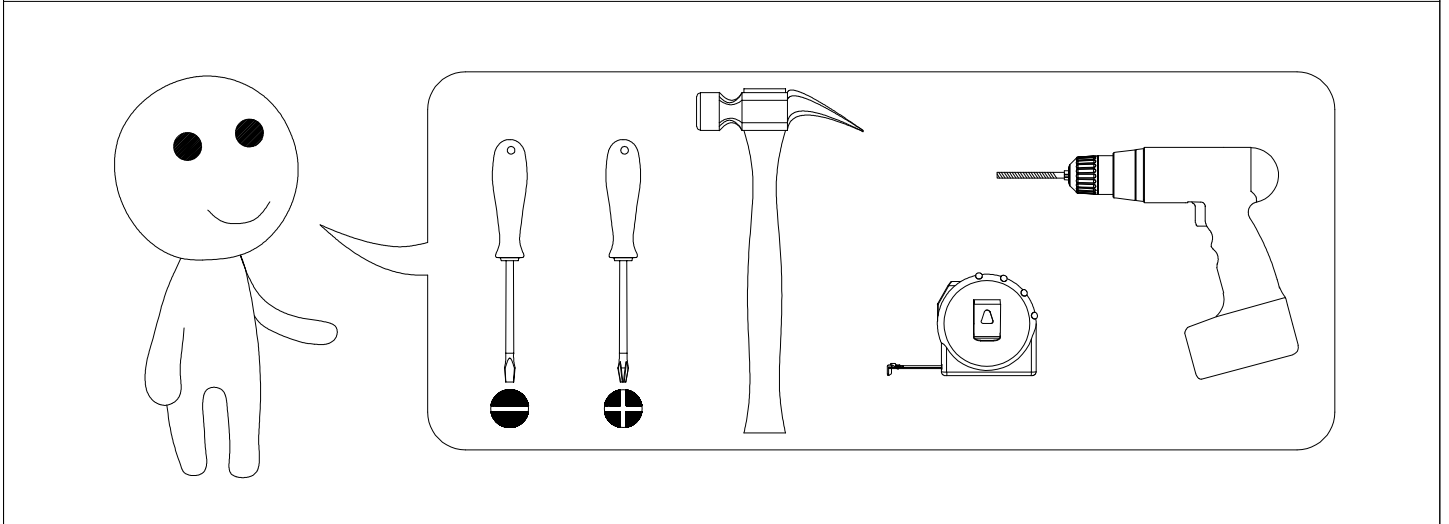
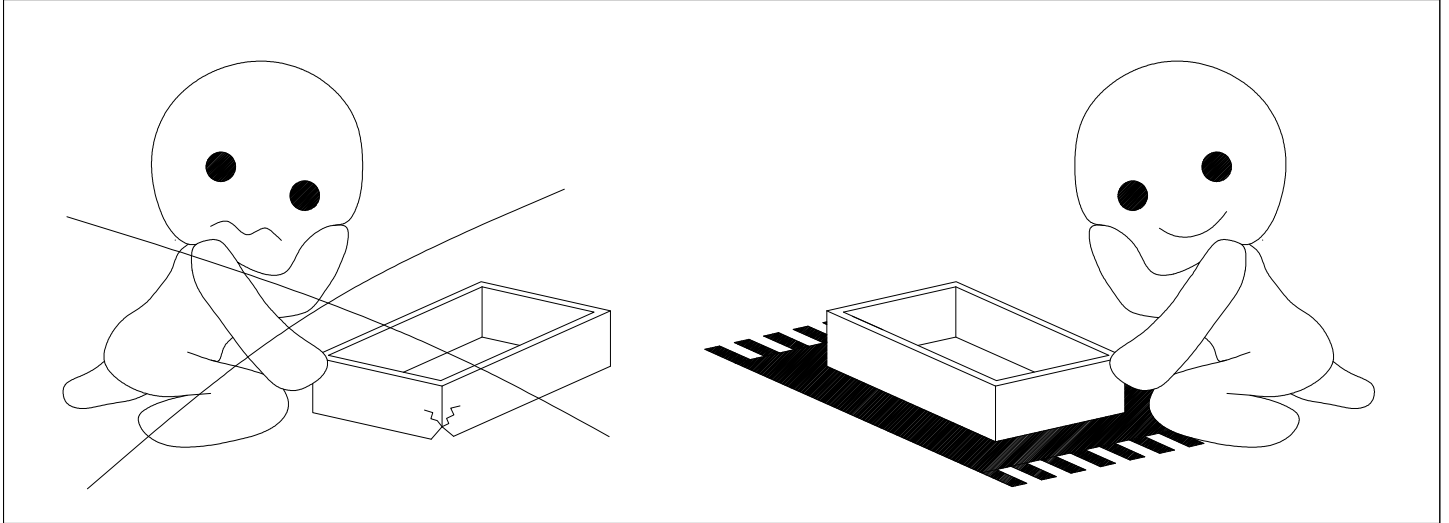
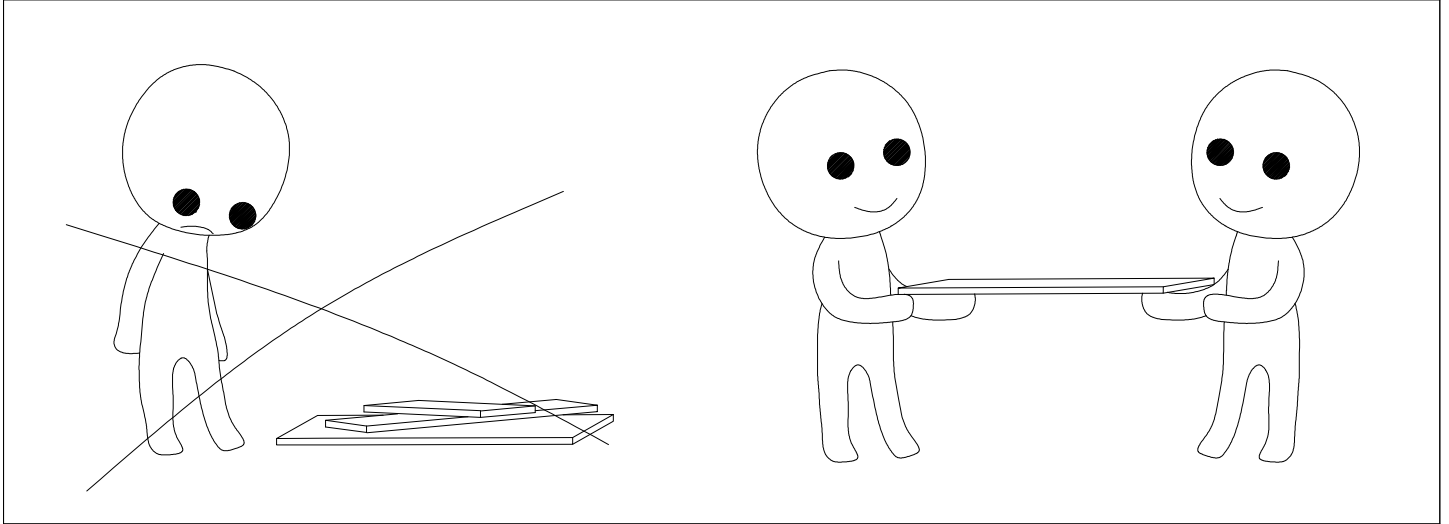
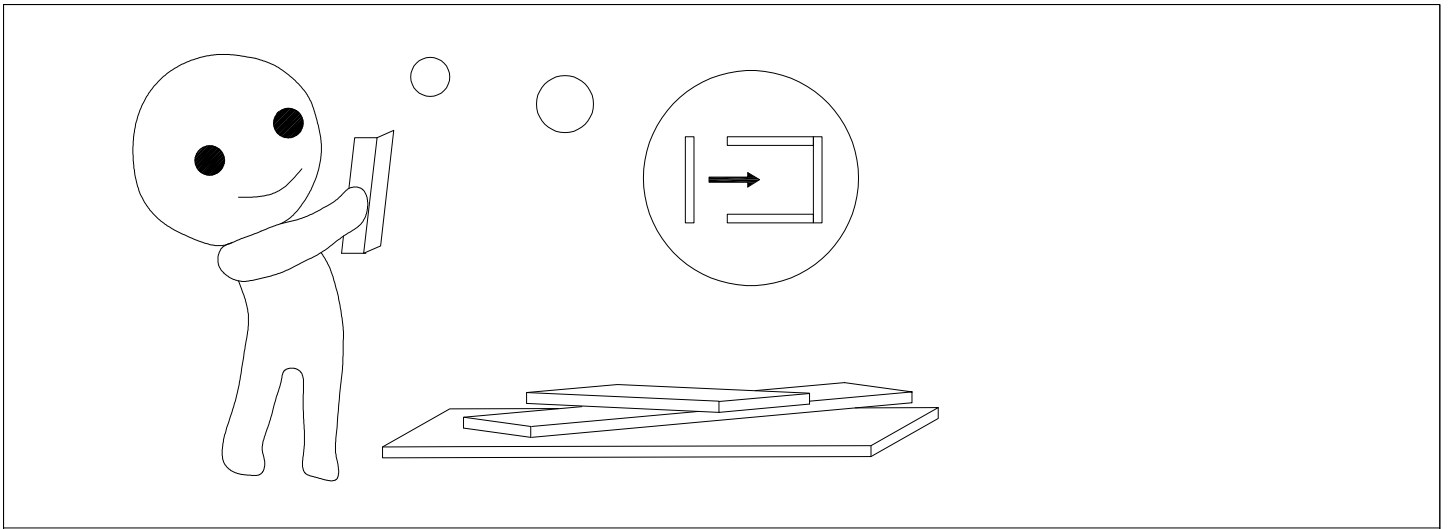
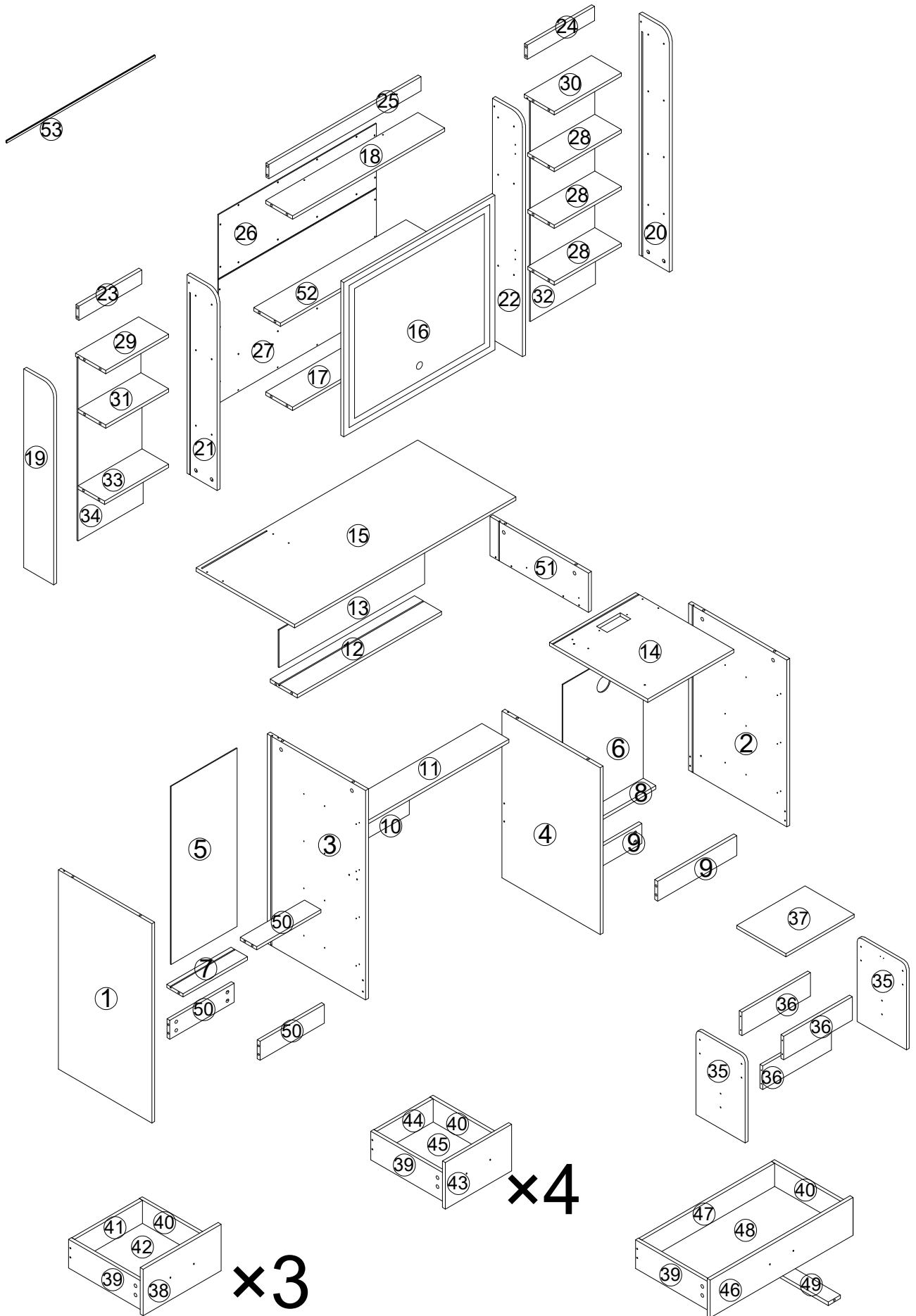
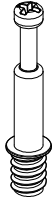

PLATE NUMBER



ACCESSORIES LIST

A ×138



M6×35

B ×138

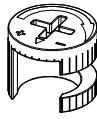

12×10

C ×47



M5×40

D ×128

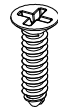

M3×12

E ×8

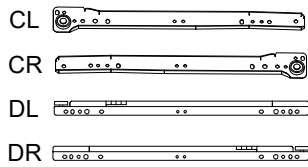

M300

F ×18

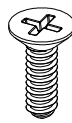

M3.5×12

G ×1

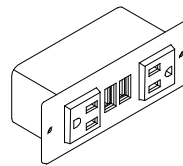

H ×26

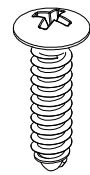

M4x12

J ×16

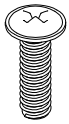

M4x14

K ×1

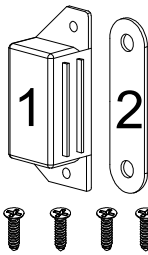

L ×12



M ×2

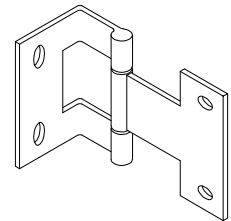

N ×2

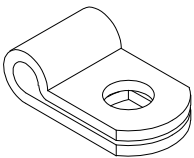

P ×14

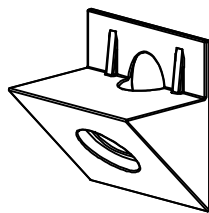

Q ×14

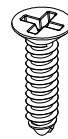

M3.5×14

R ×1

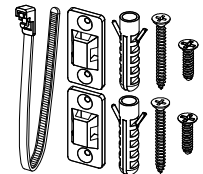

S ×2

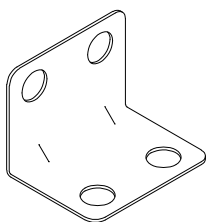

T ×8

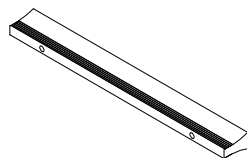

M96

×1

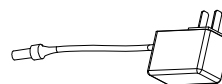

STEP1

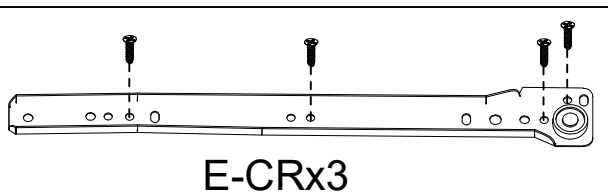
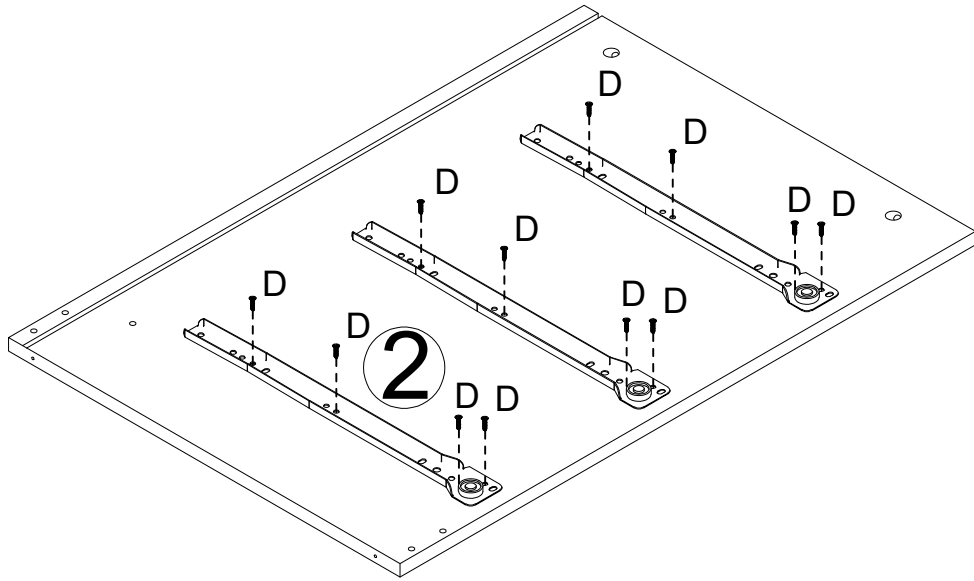
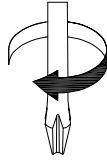

Dx12

STEP2

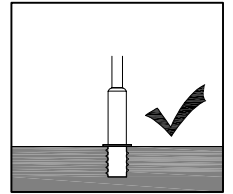
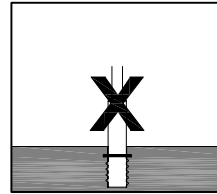
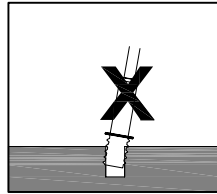
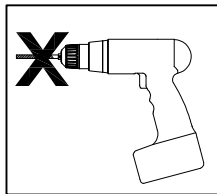

Iron Rod A is prohibited from using an electric drill.

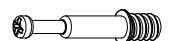
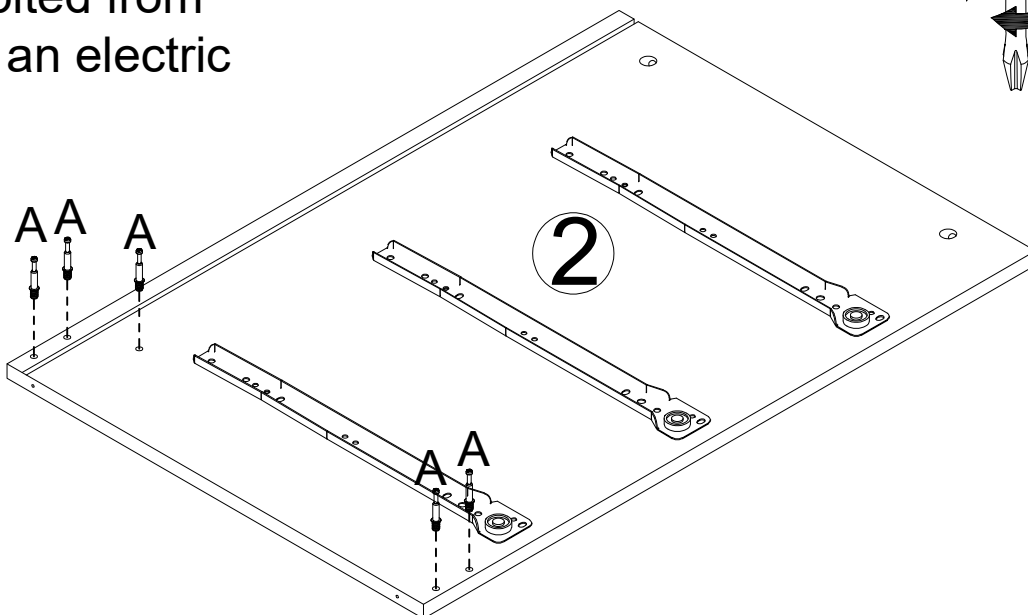
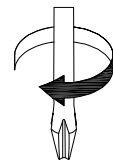

Ax5

STEP3

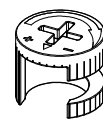
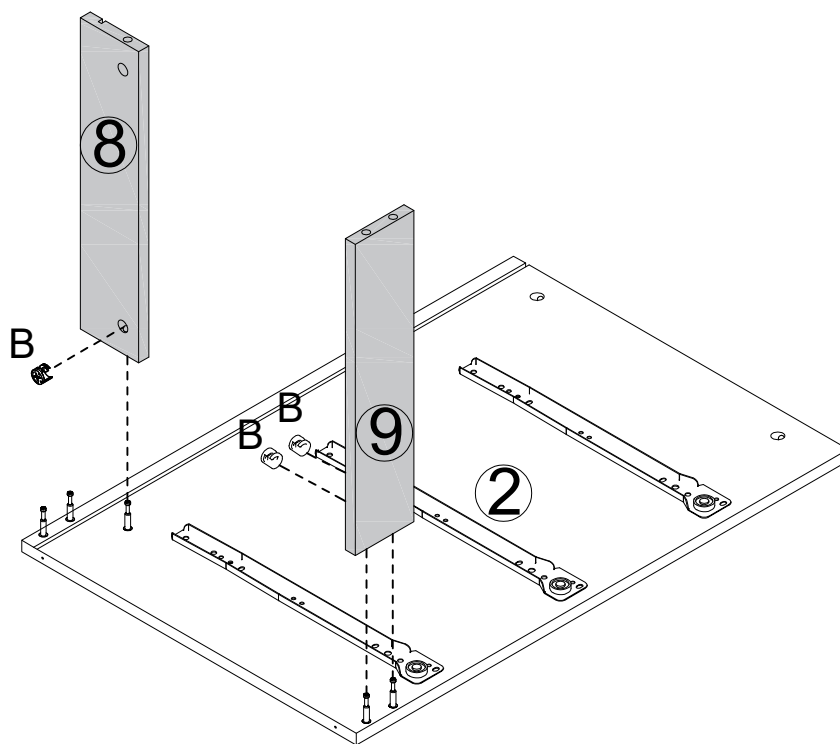
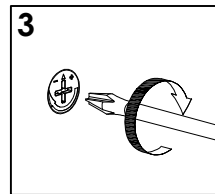
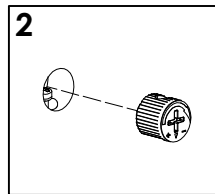
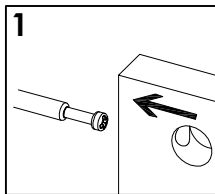
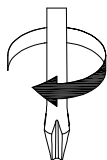

Bx3

STEP4

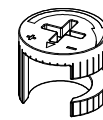
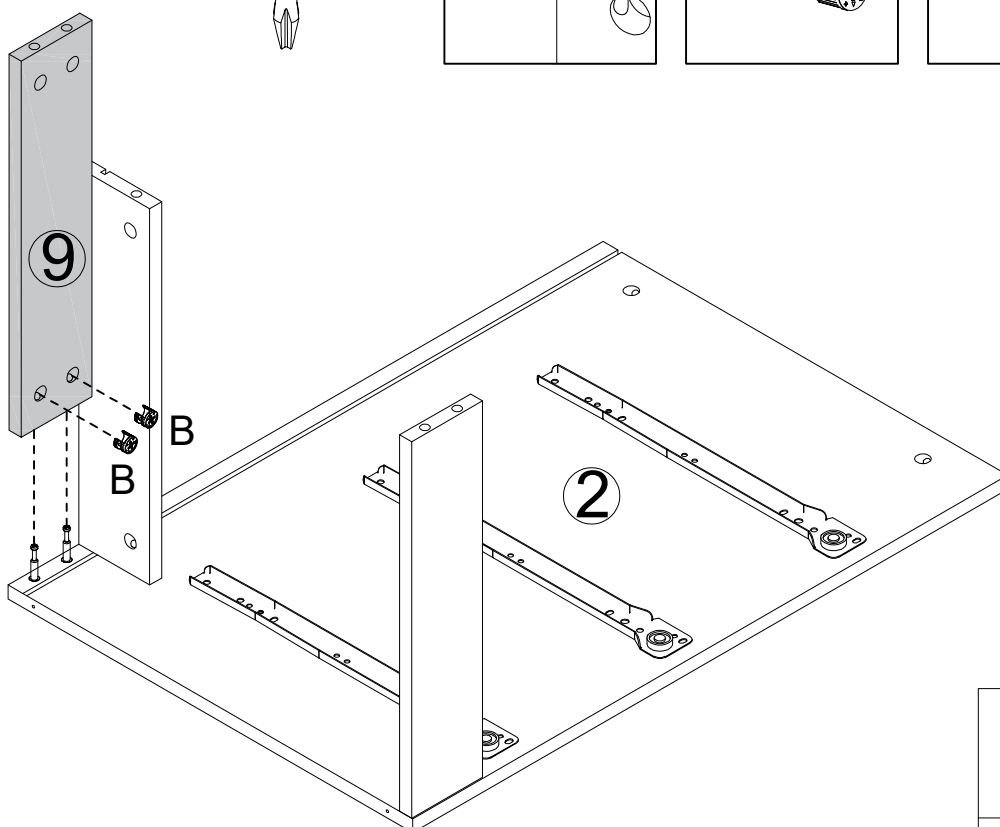
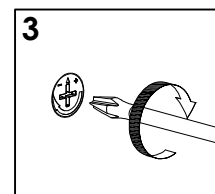
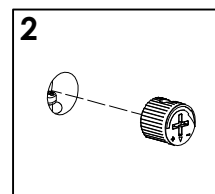
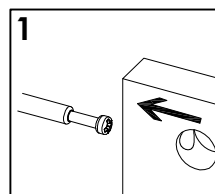
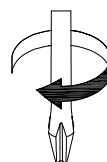

Bx2

STEP5

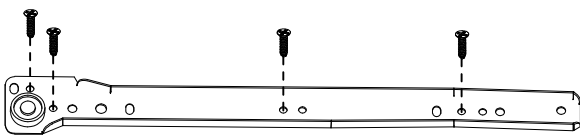
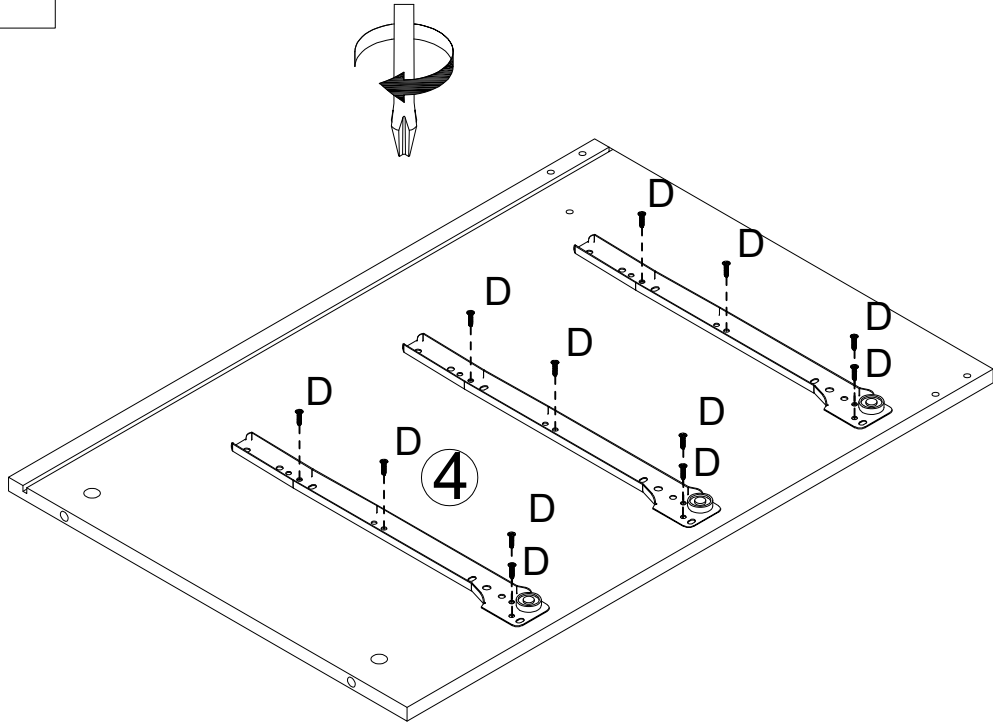

E-CLx3



Dx12

STEP6

Iron Rod A is prohibited from using an electric drill.

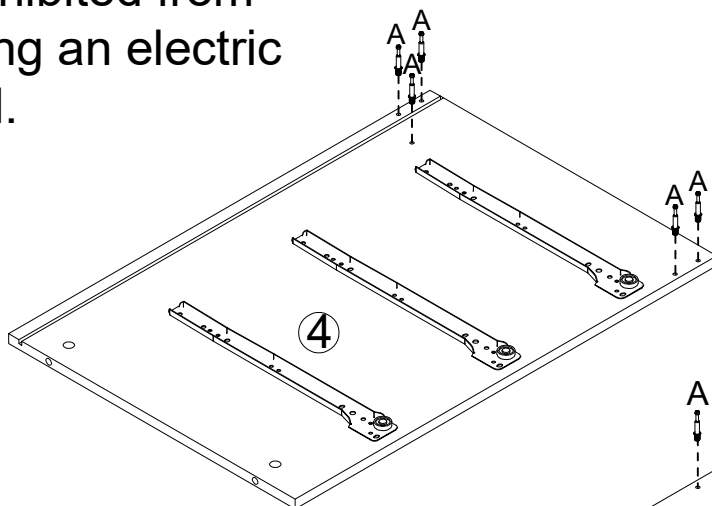
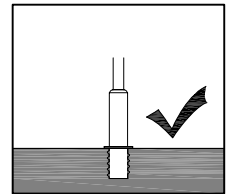
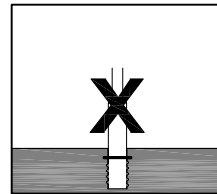
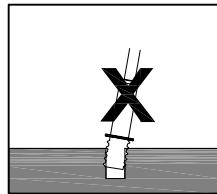
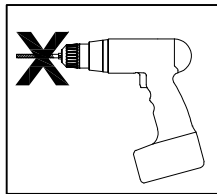

180°

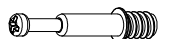
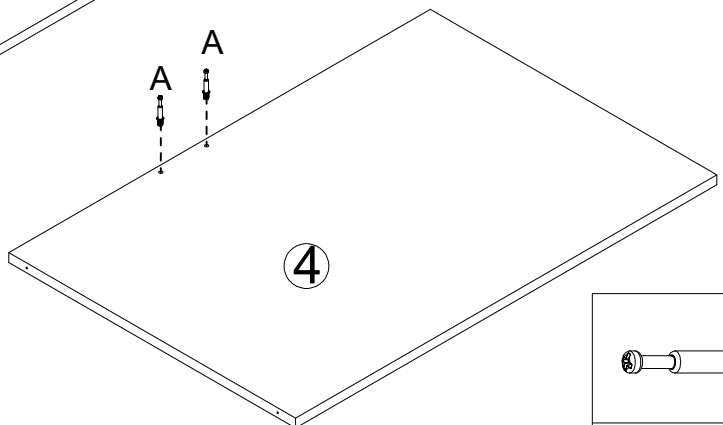

Ax7

STEP 7

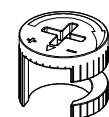
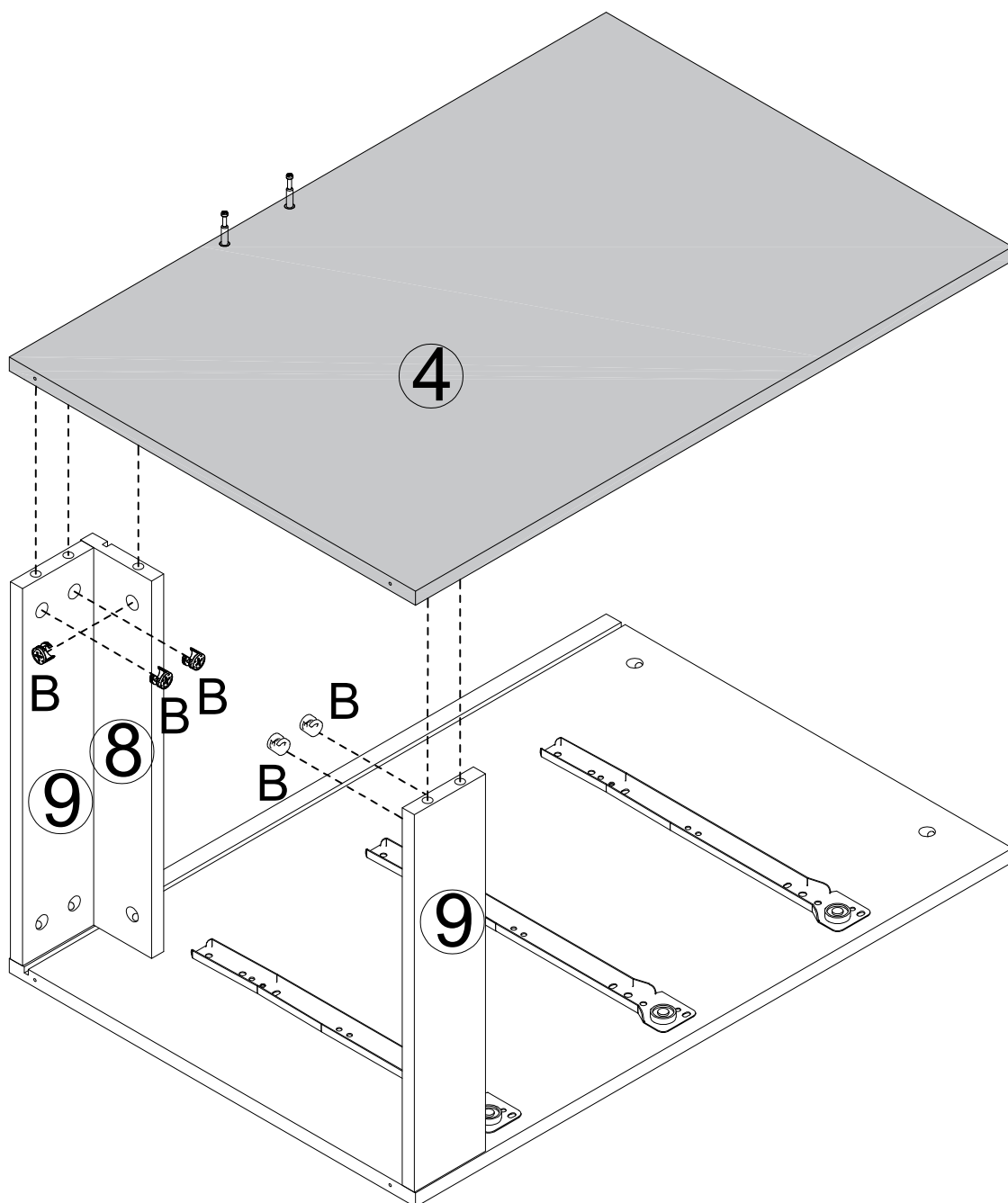
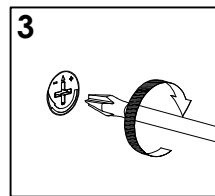
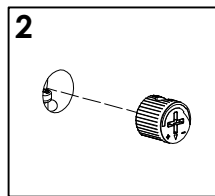
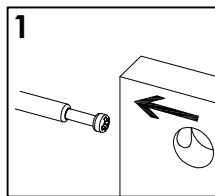
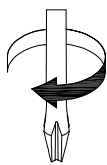

Bx5

STEP8

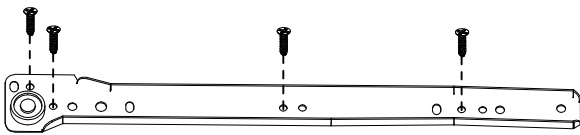
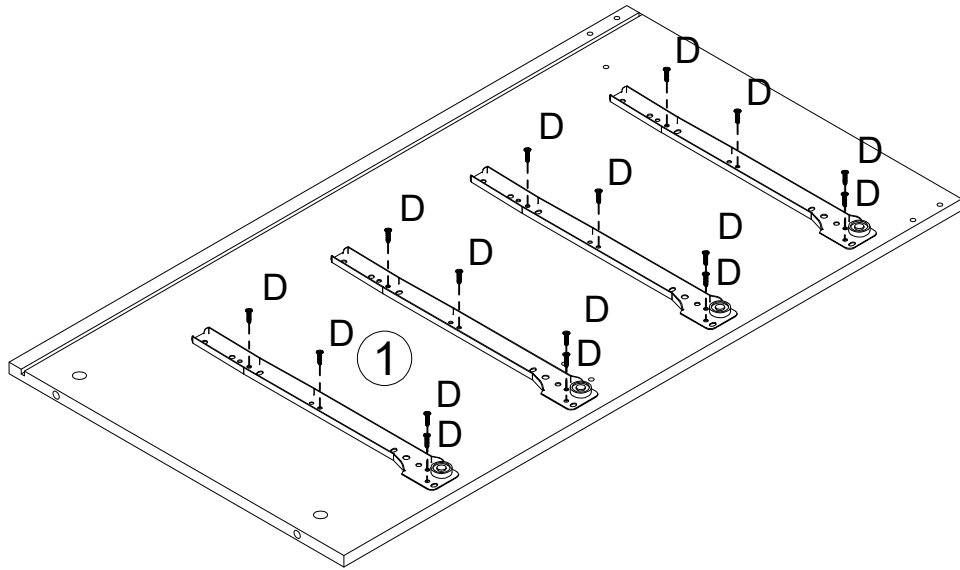
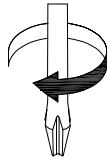

E-CLx4



Dx16

STEP9

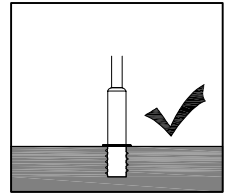
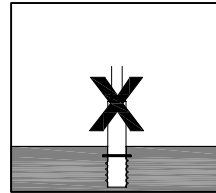
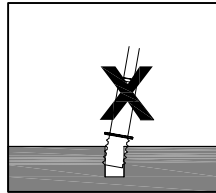
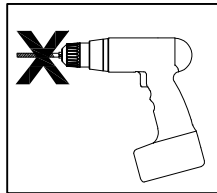

Iron Rod A is prohibited from using an electric drill.

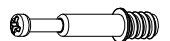
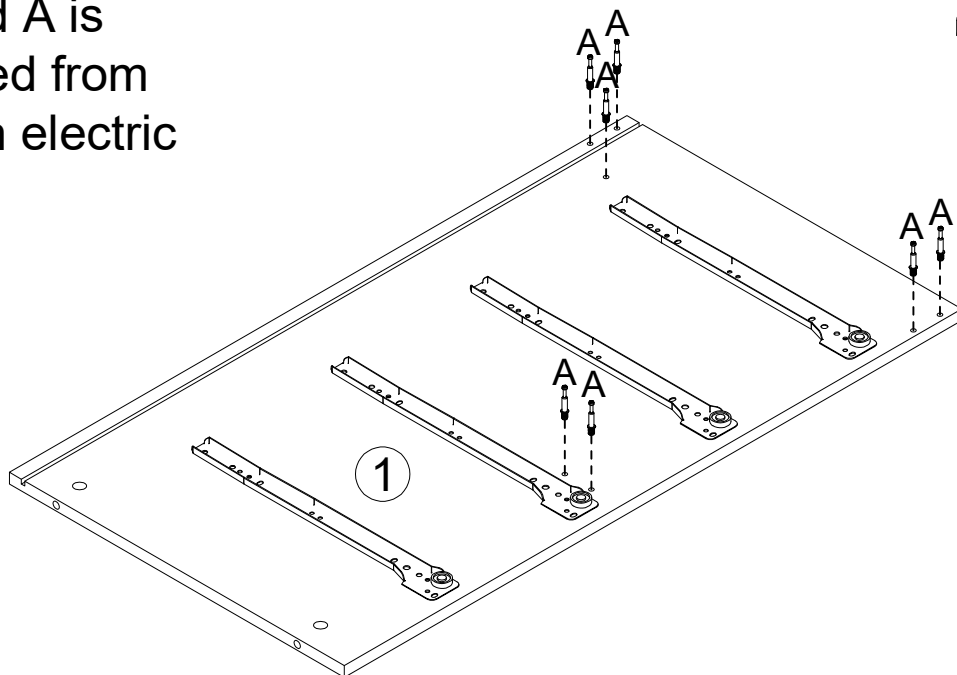
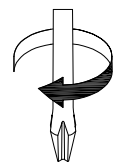

Ax7

STEP10

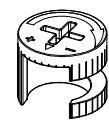
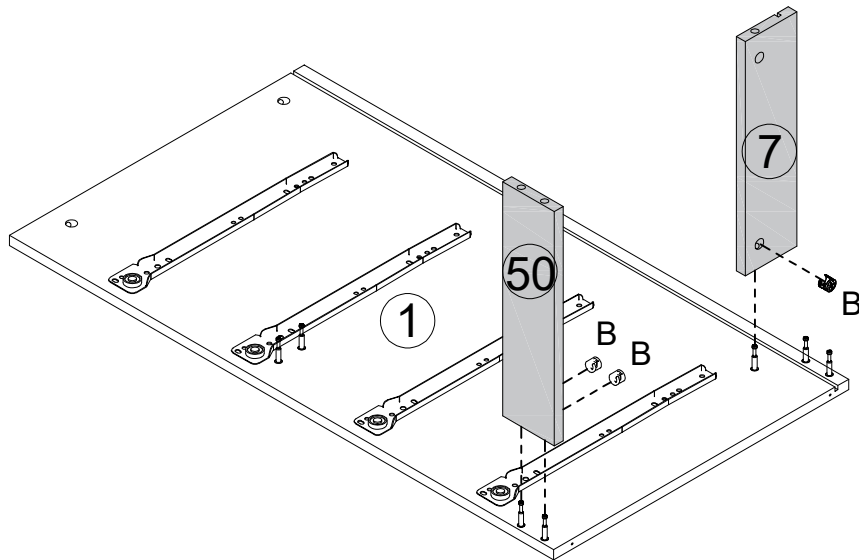
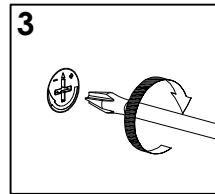
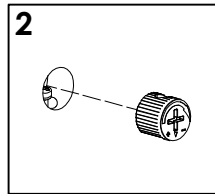
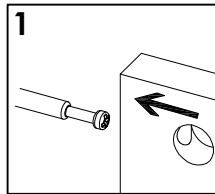
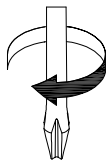

Bx3

STEP11

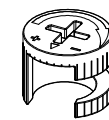
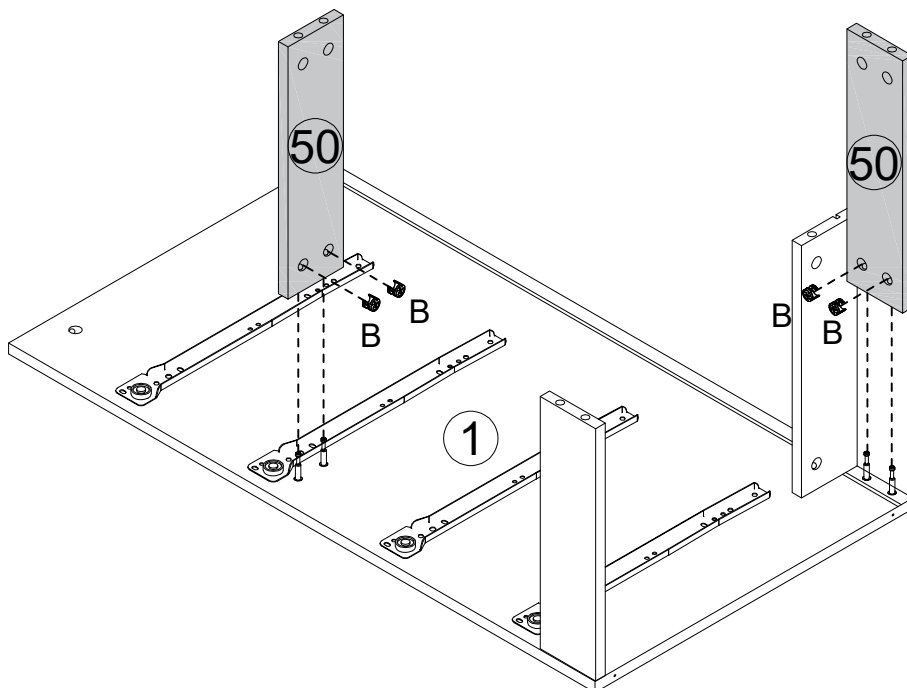
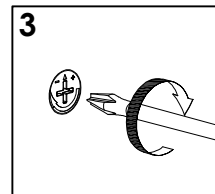
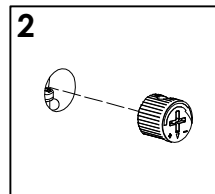
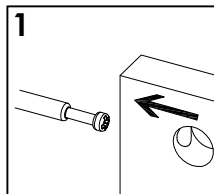
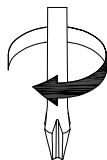

Bx4

STEP 12

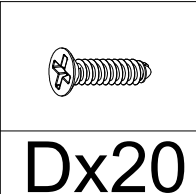
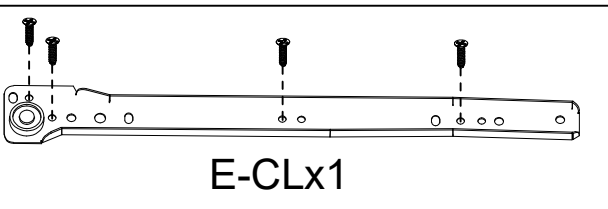
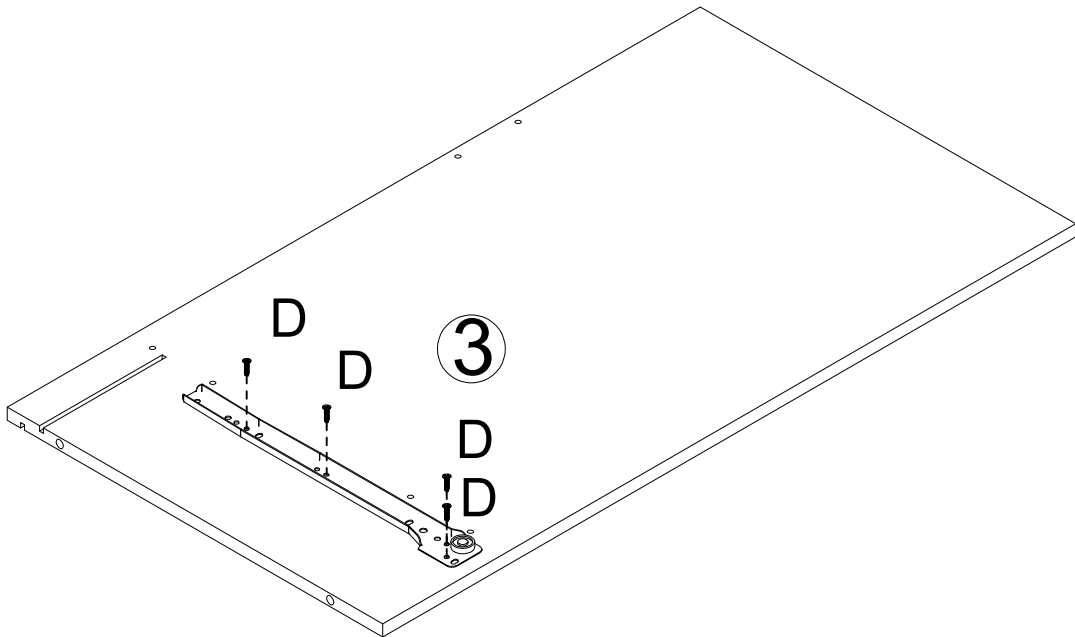
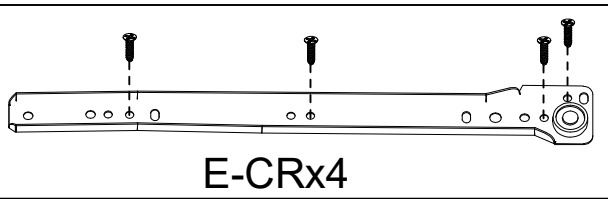
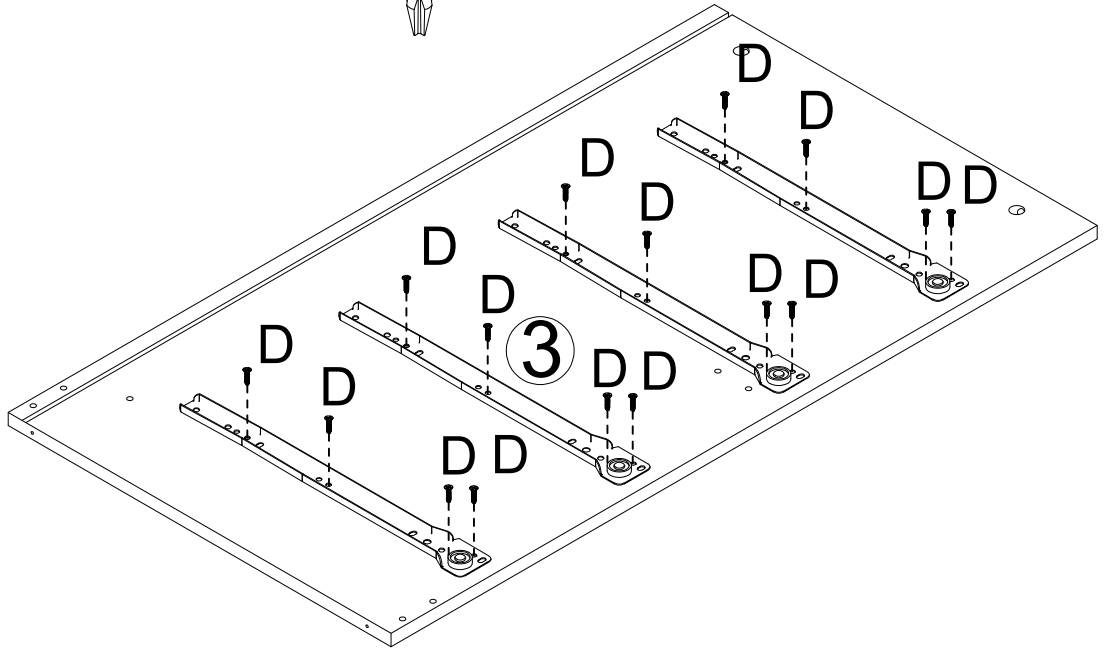
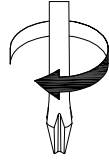

STEP 13

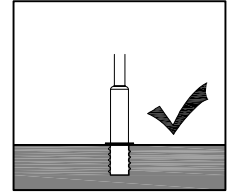
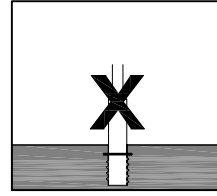
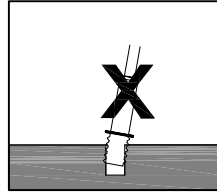
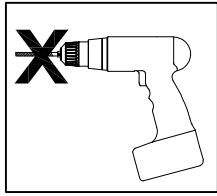

Iron Rod A is prohibited from using an electric drill.

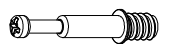
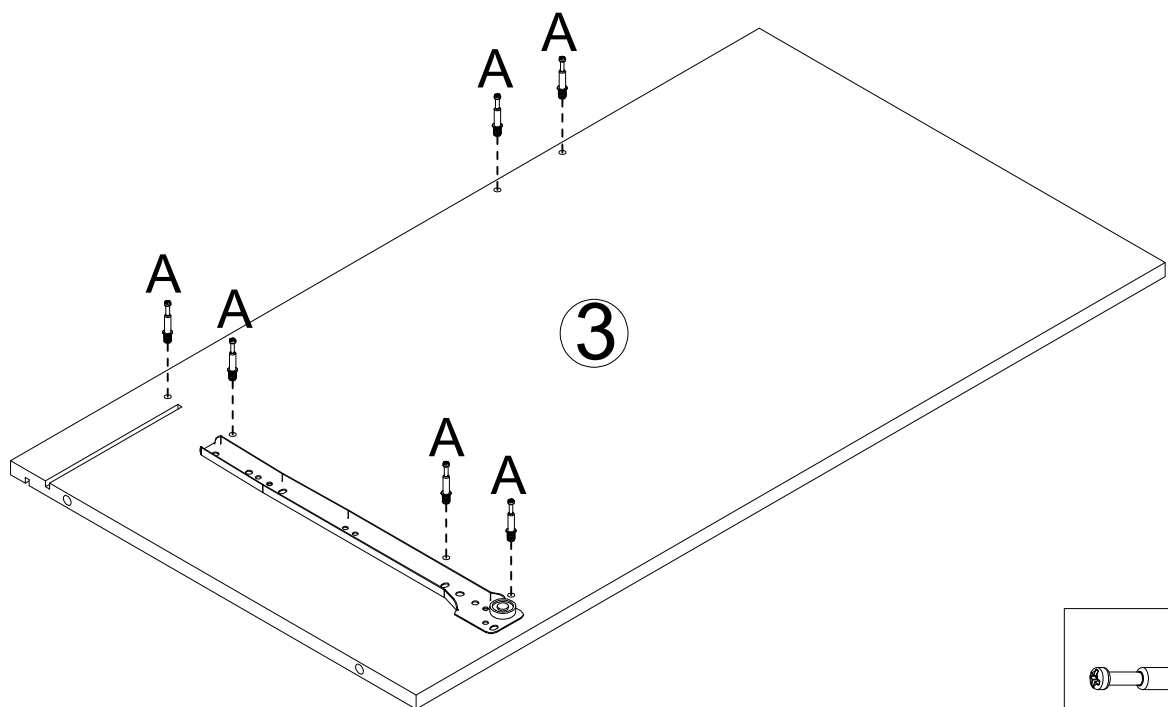
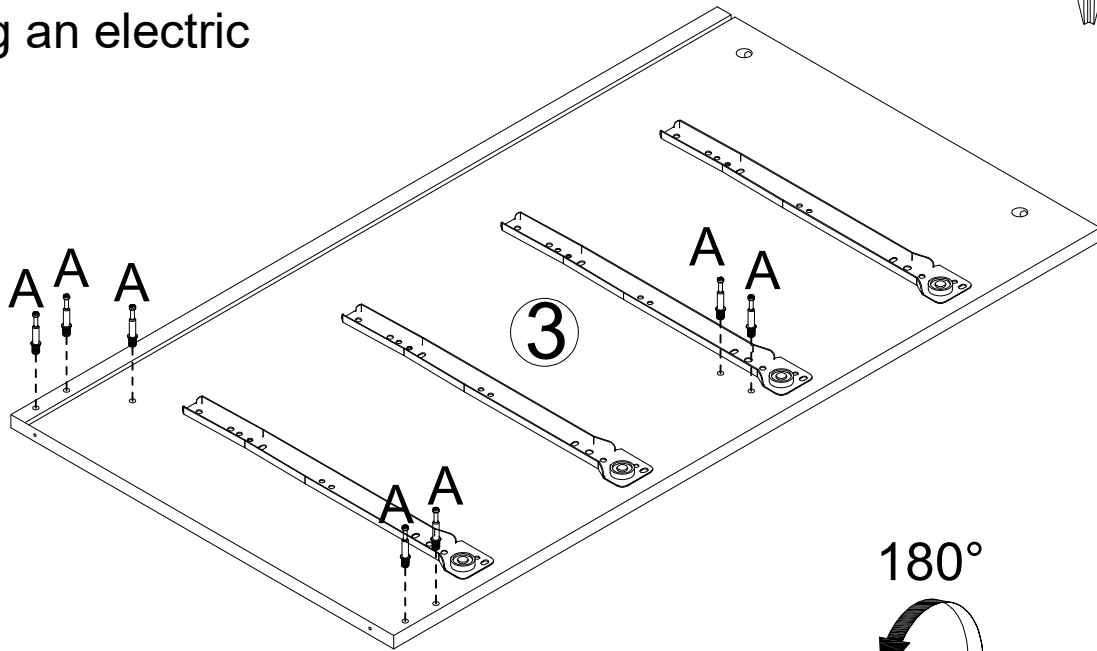
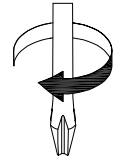

Ax13

STEP14

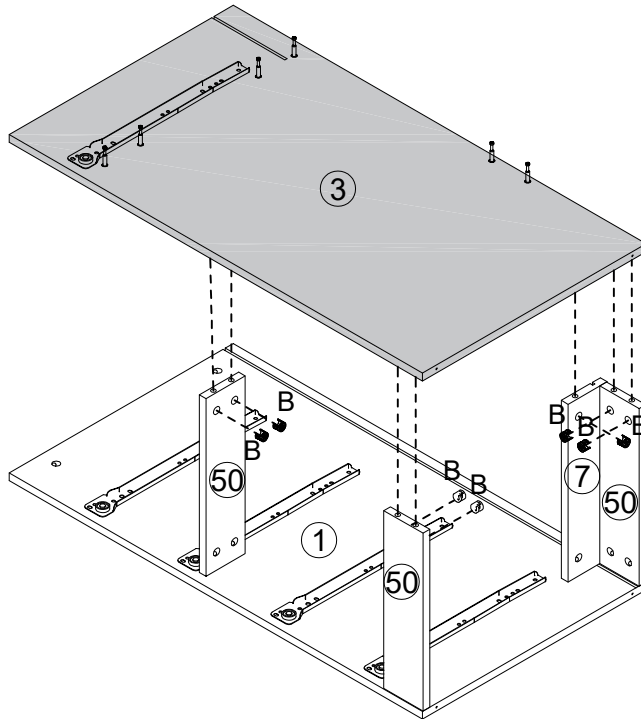
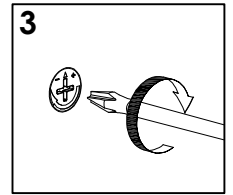
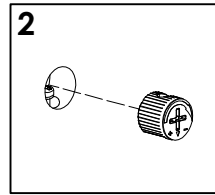
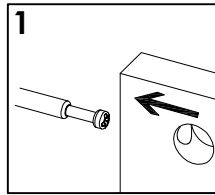
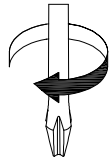

Bx7

STEP15

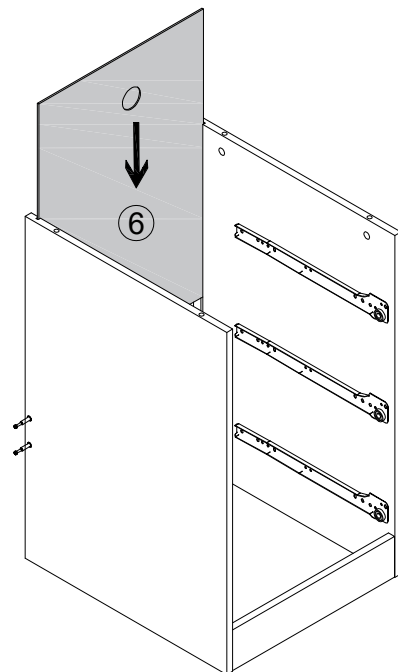
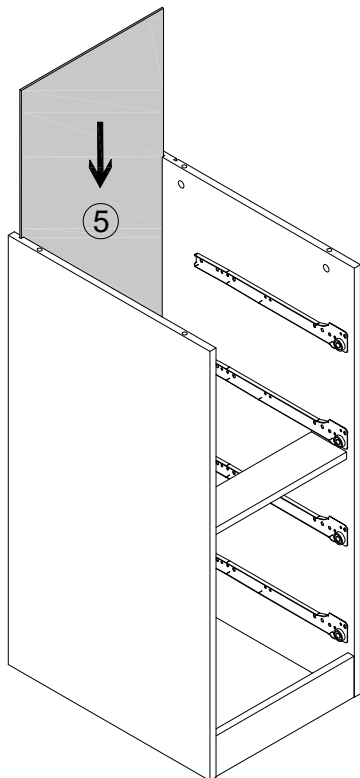

STEP 16

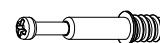
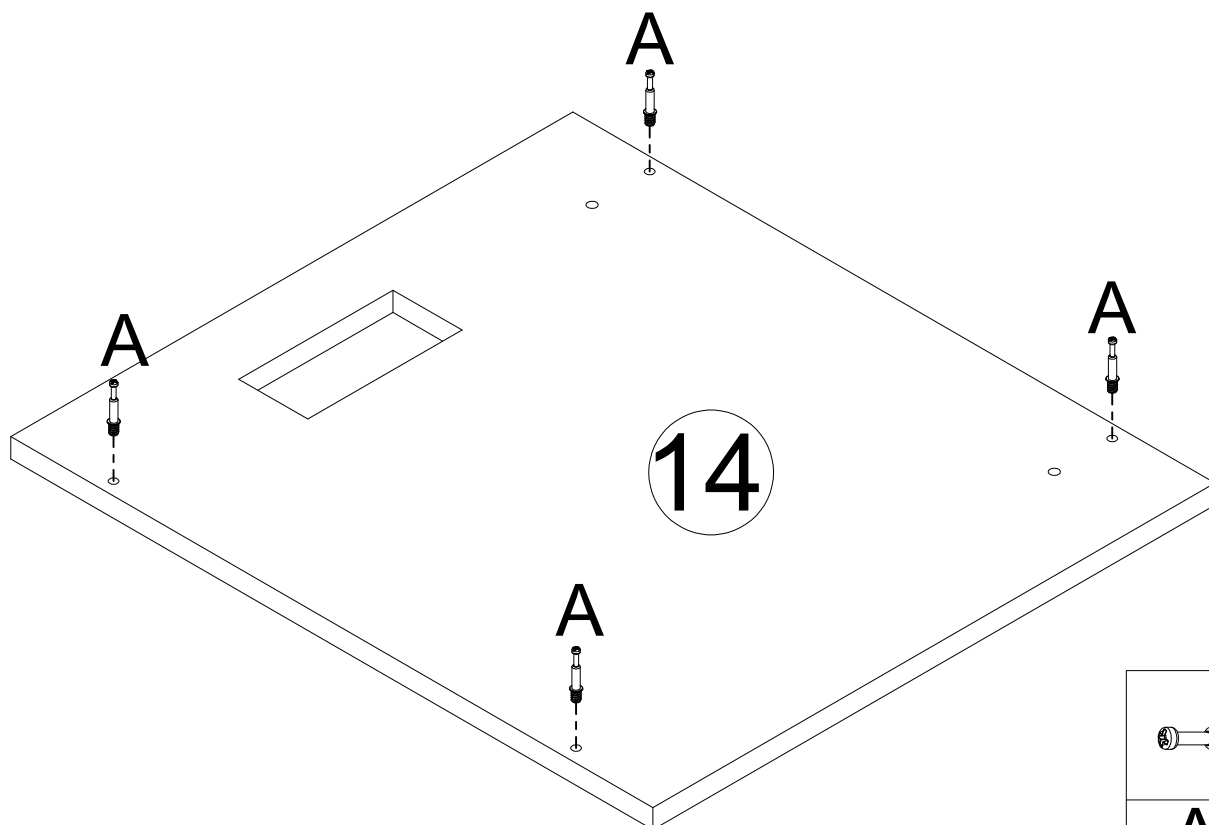
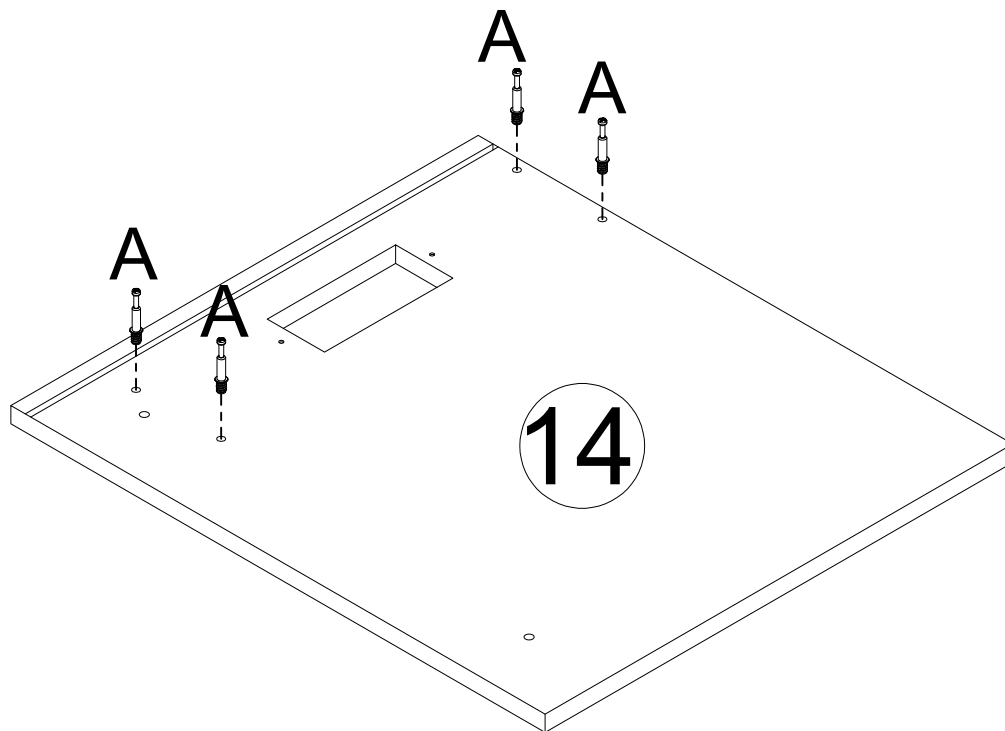
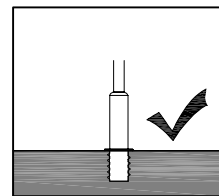
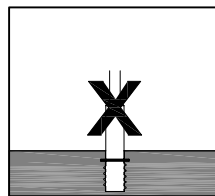
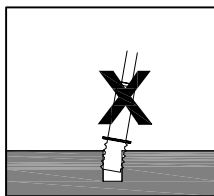
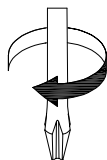

Ax8

STEP17

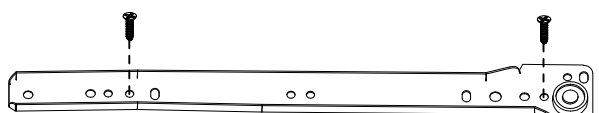
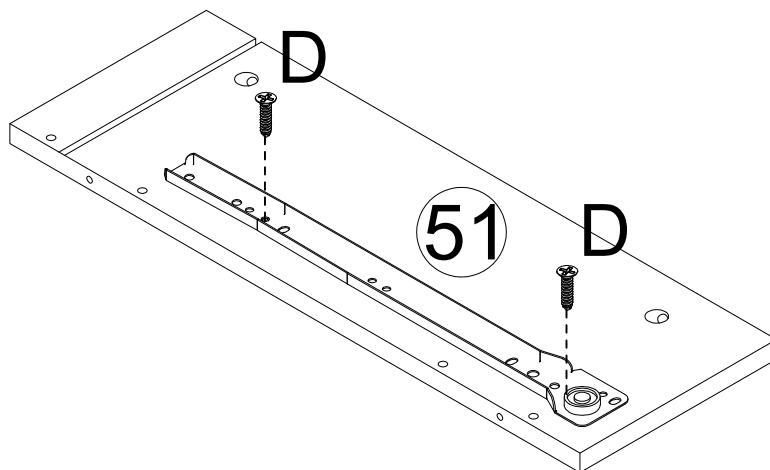
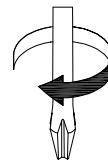

E-CRx1



Dx2

STEP18

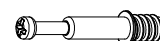
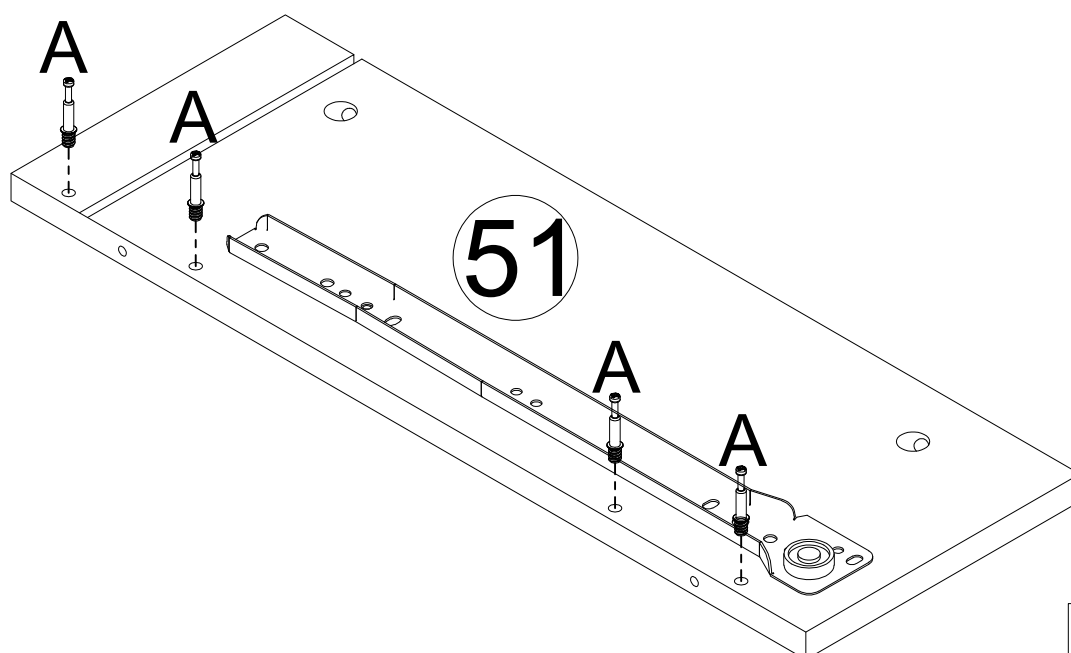
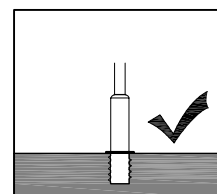
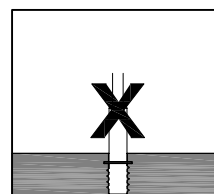
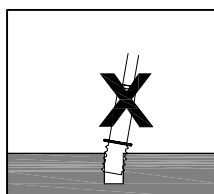
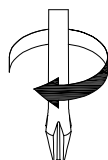

Ax4

STEP19

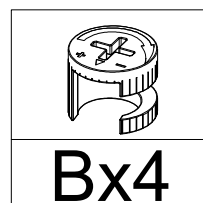
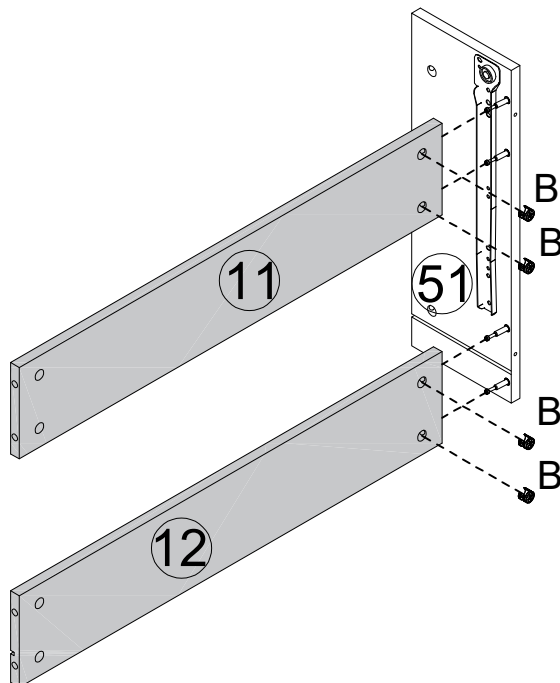
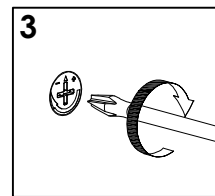
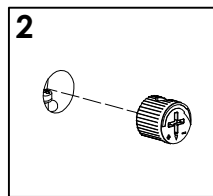
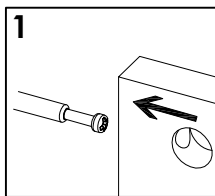
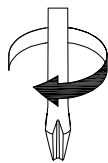

STEP20

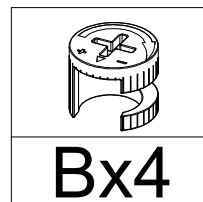
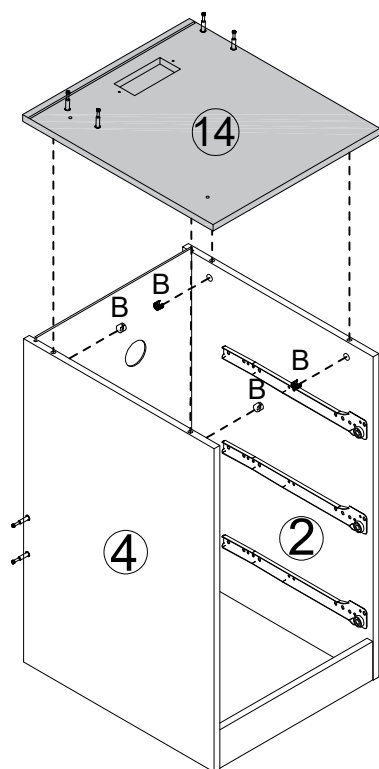
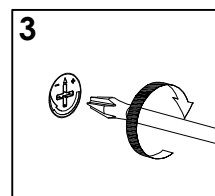
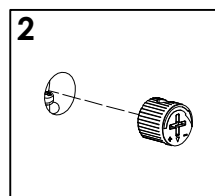
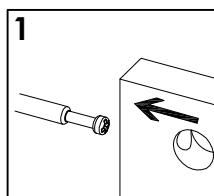
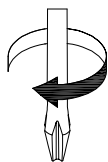

STEP21

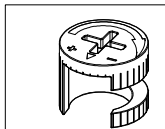
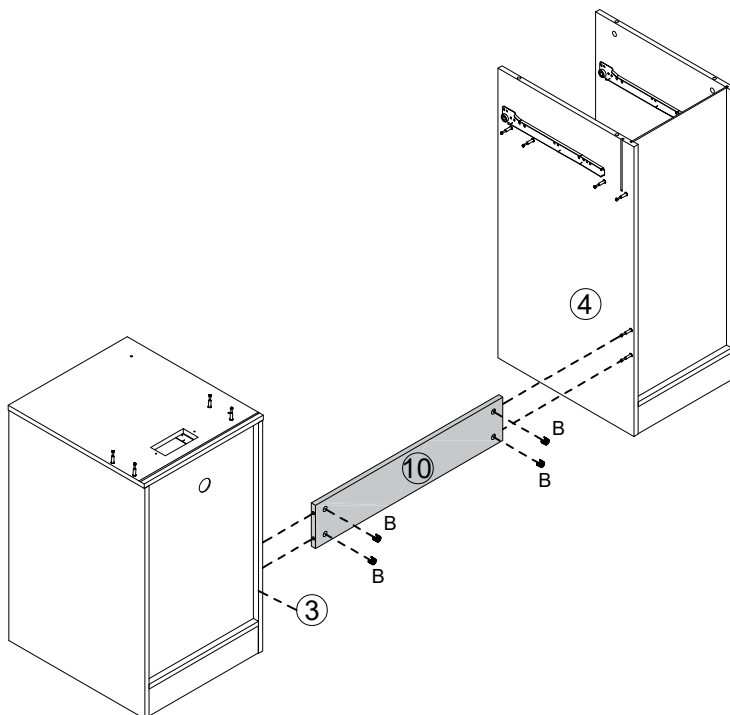
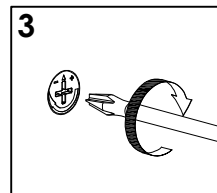
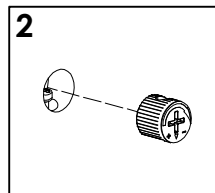
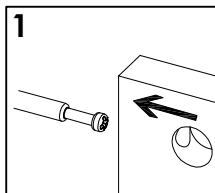
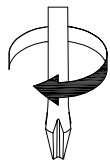

Bx4

STEP22

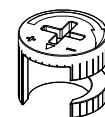
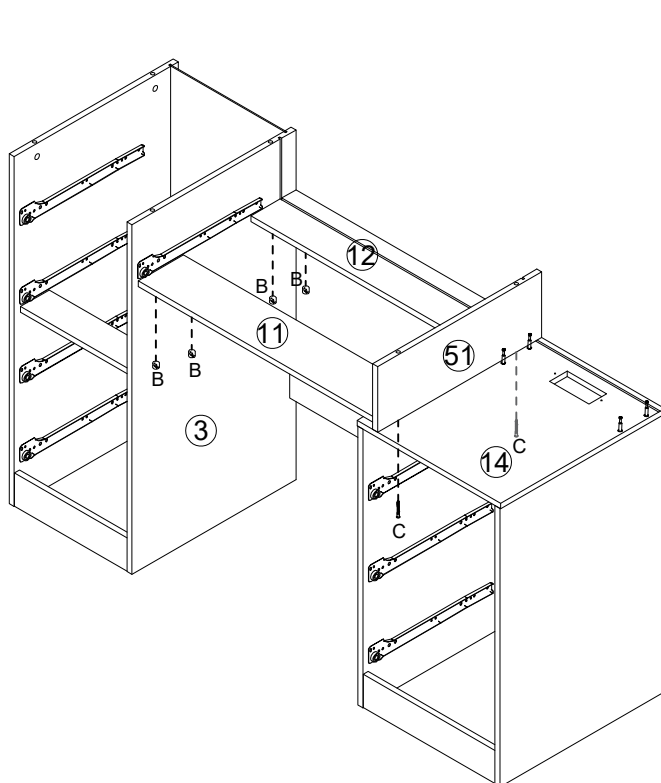
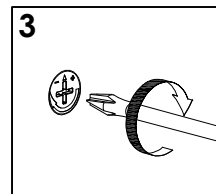
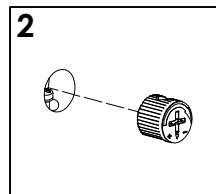
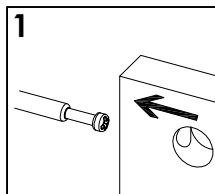
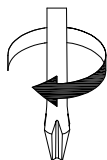

Bx4



Cx2

STEP23

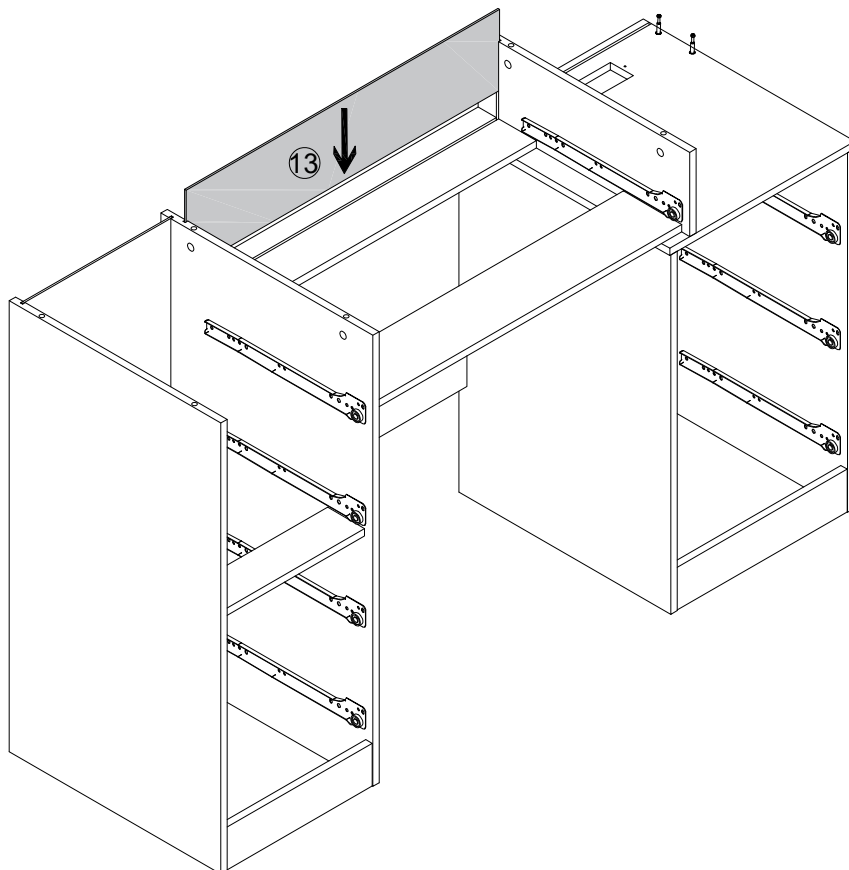

STEP24

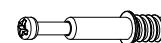
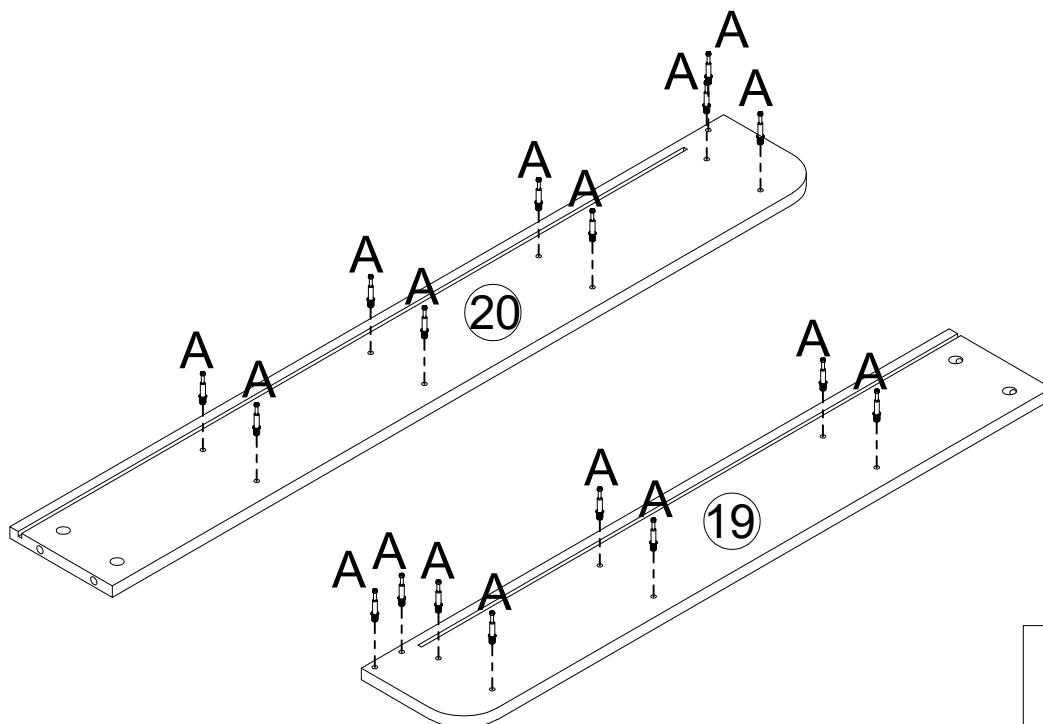
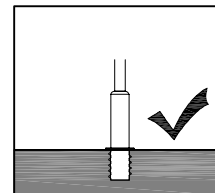
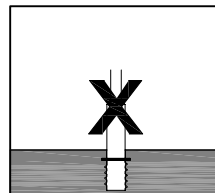
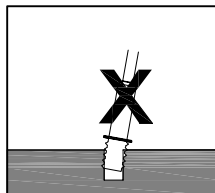
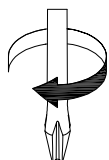

Ax17

STEP25

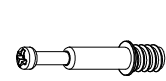
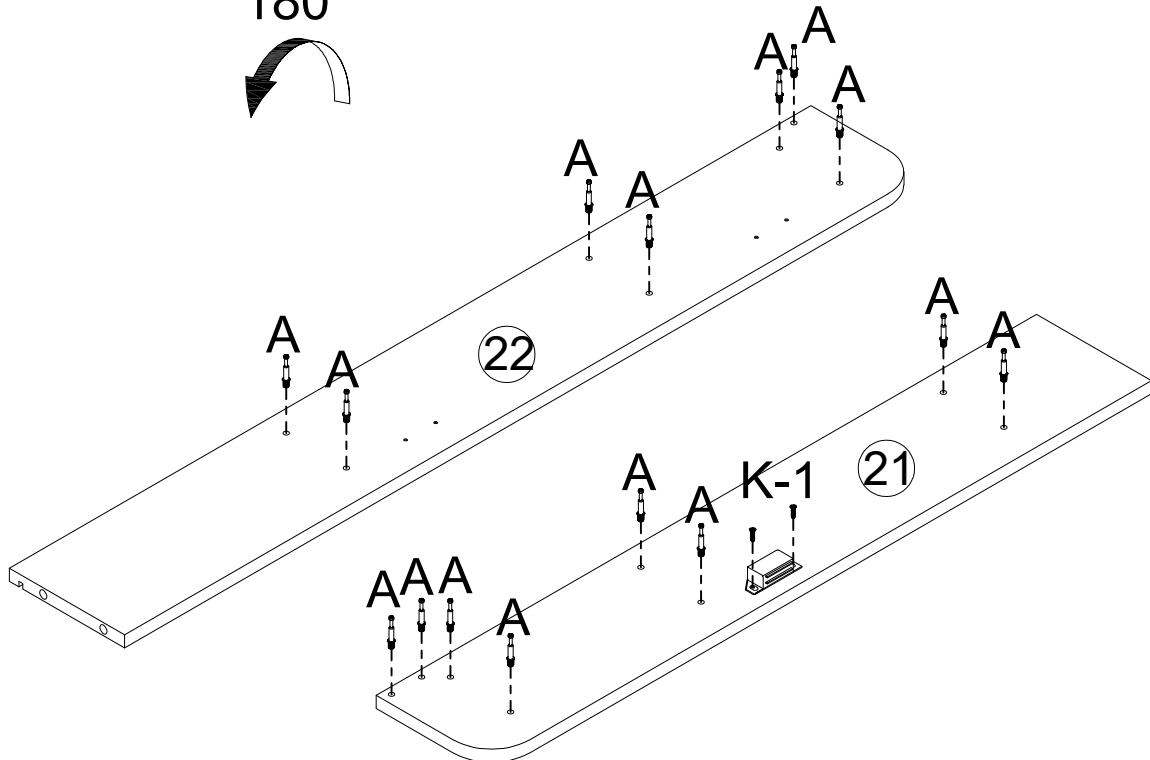
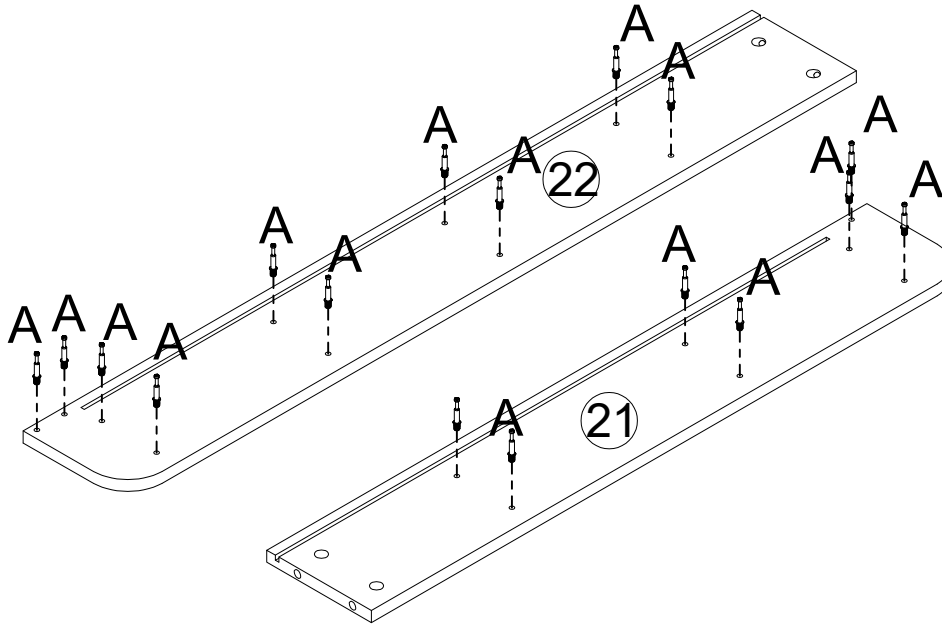
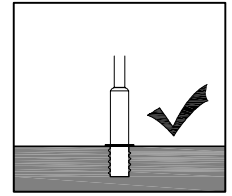
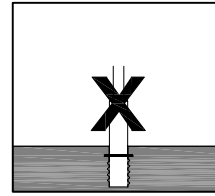
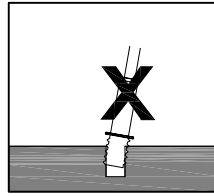
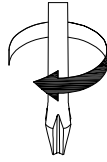

Ax32

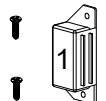

K-1x1

STEP26

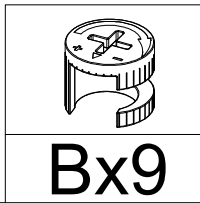
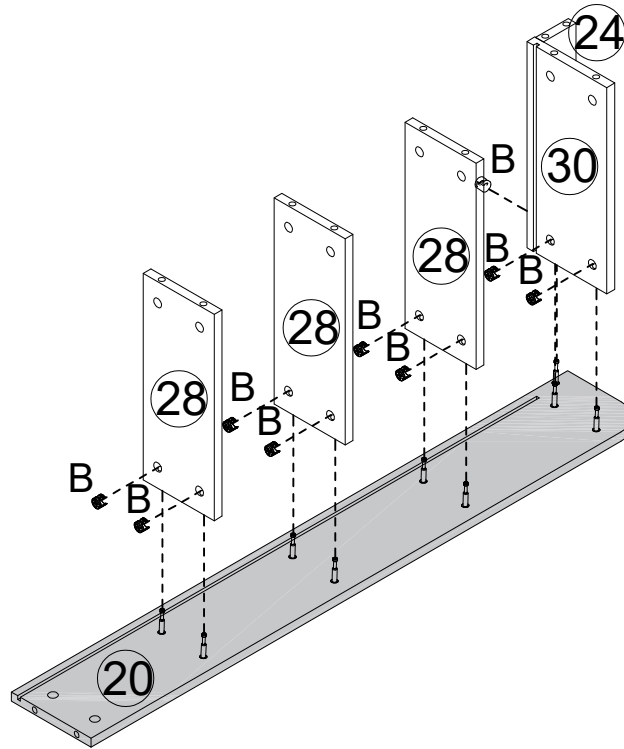
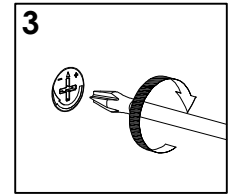
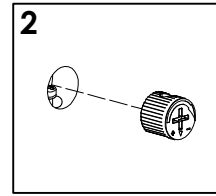
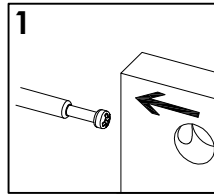
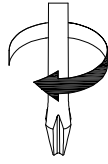

STEP27

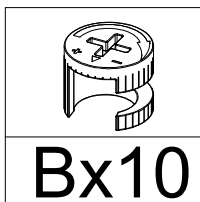
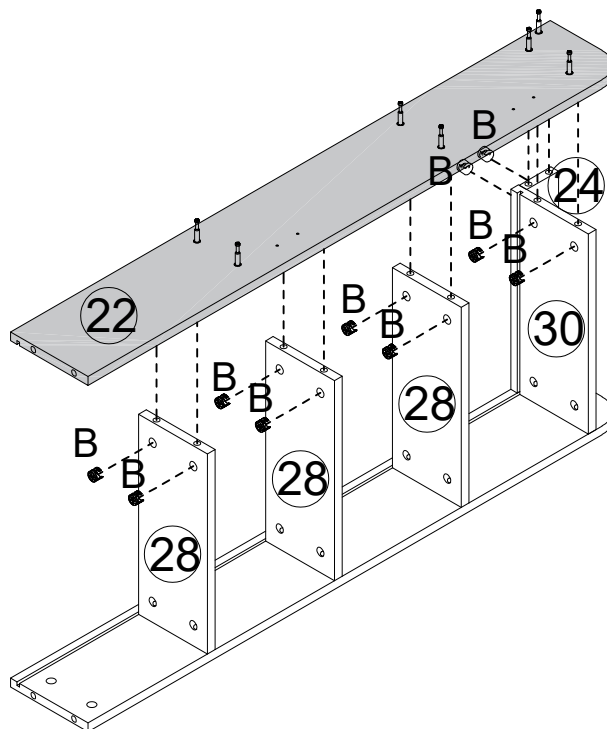
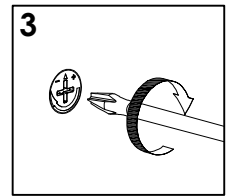
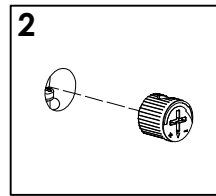
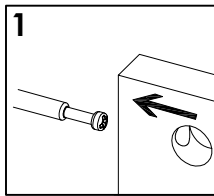
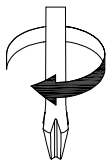

STEP28

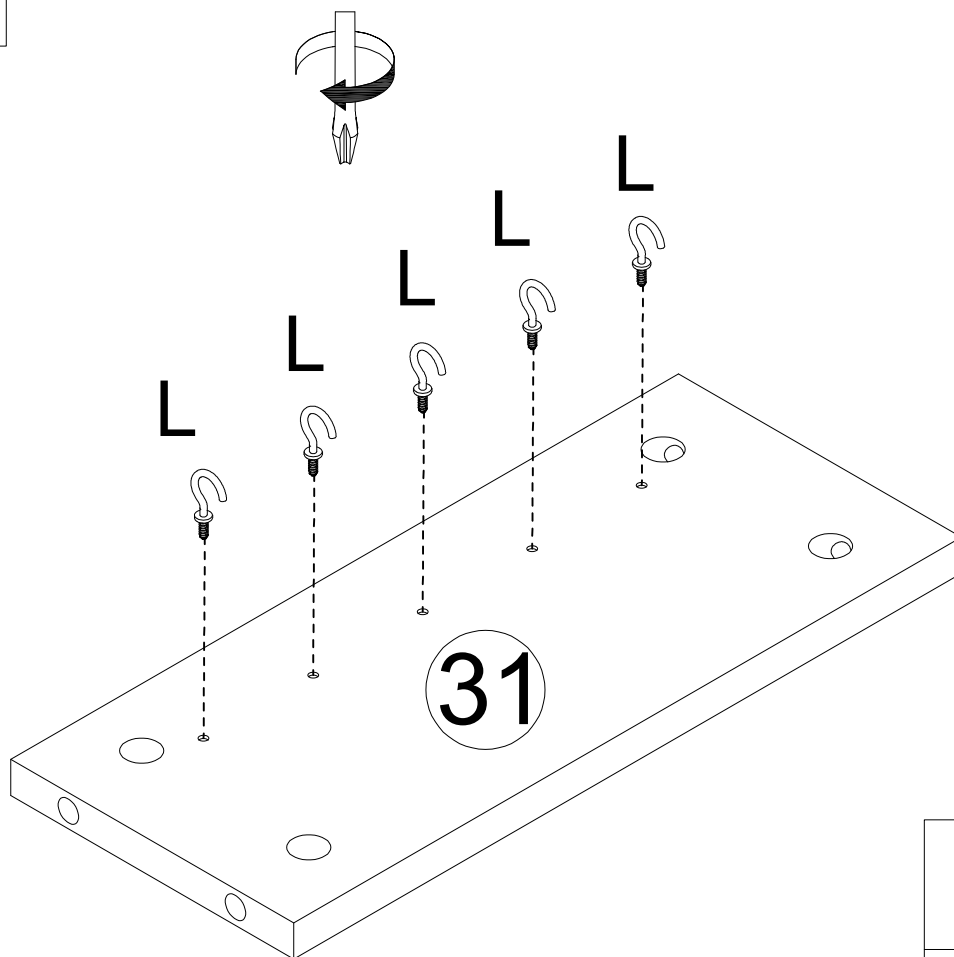

Lx5

STEP29

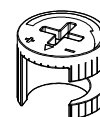
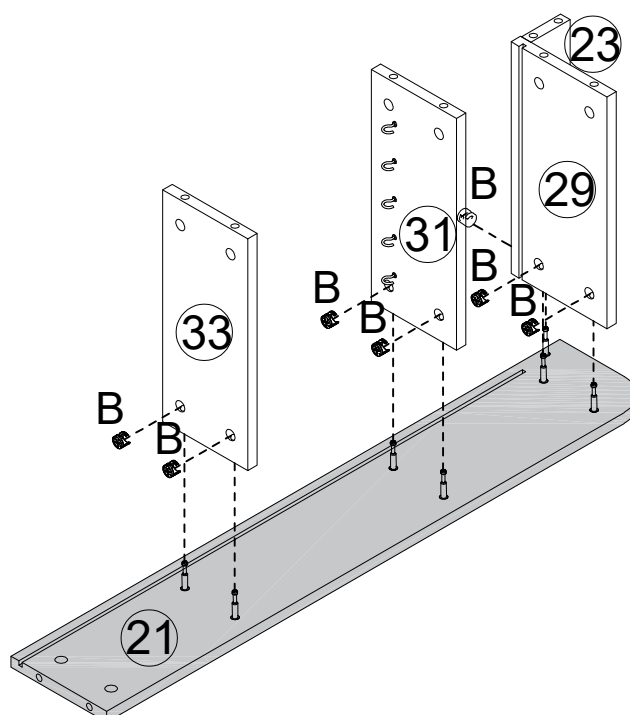
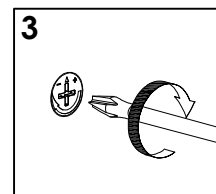
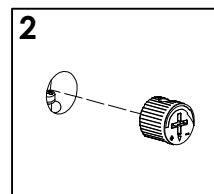
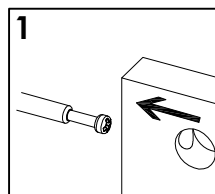
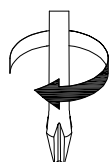

Bx7

STEP30

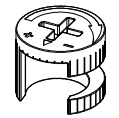
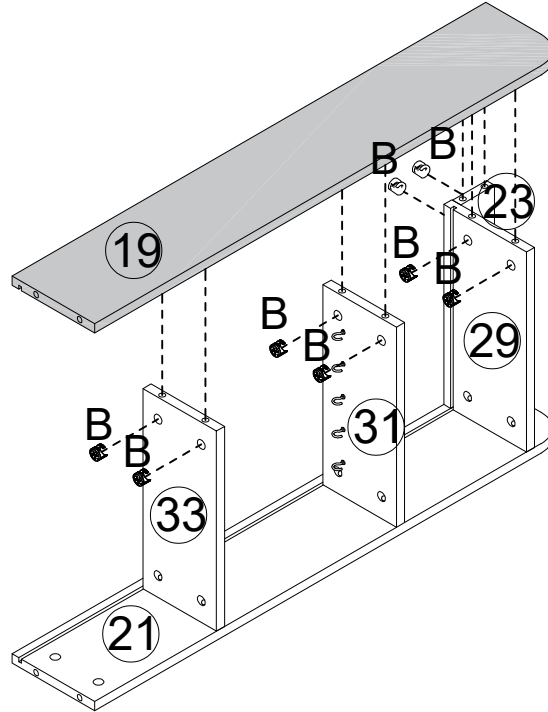
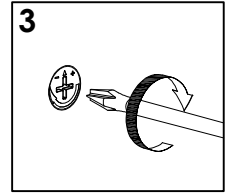
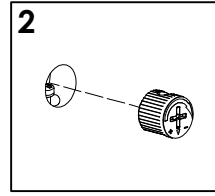
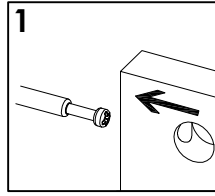
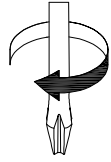

Bx8

STEP31

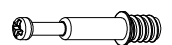
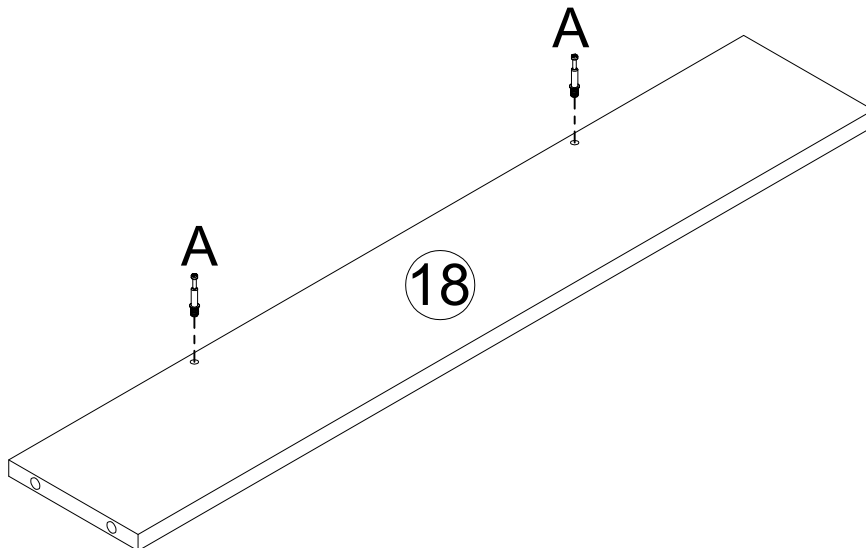
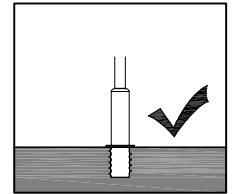
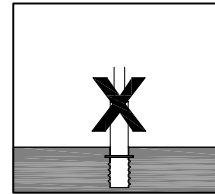
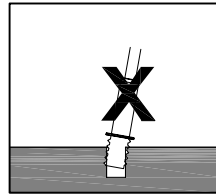
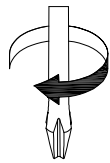

Ax2

STEP32

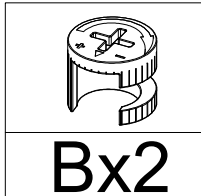
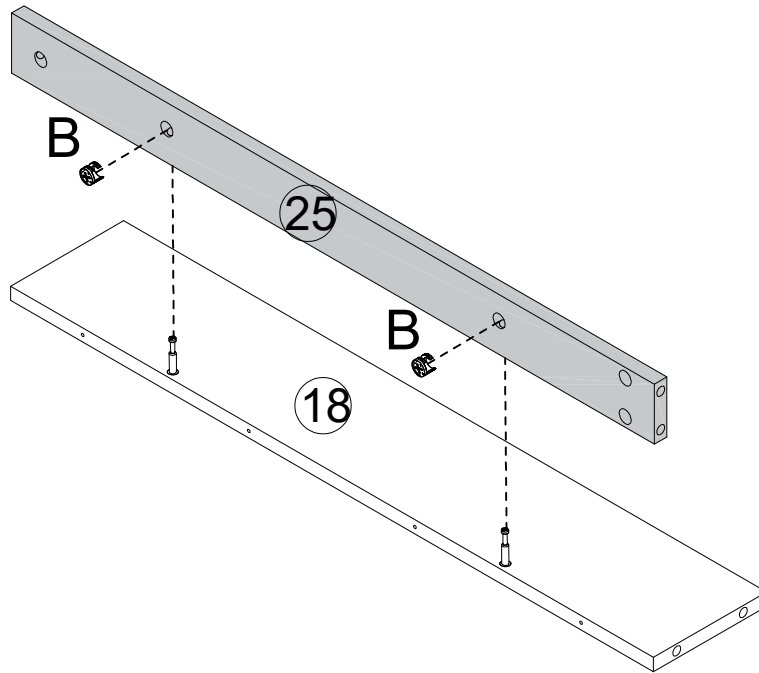
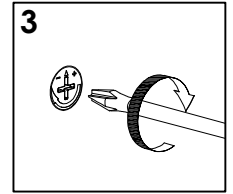
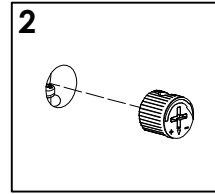
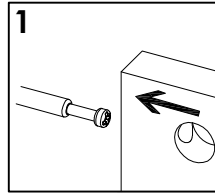
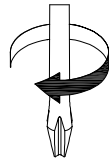

STEP33

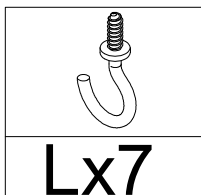
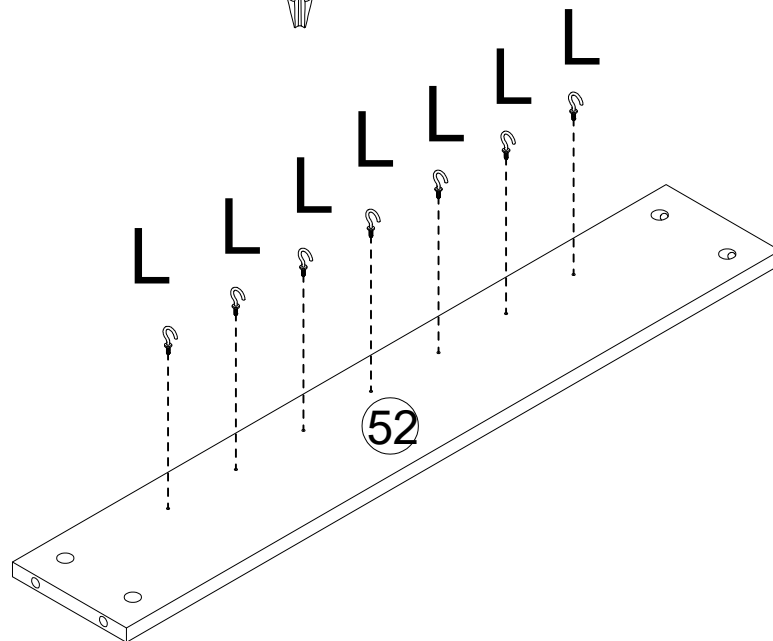
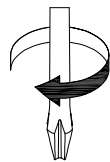

STEP34

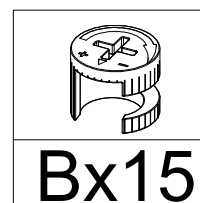
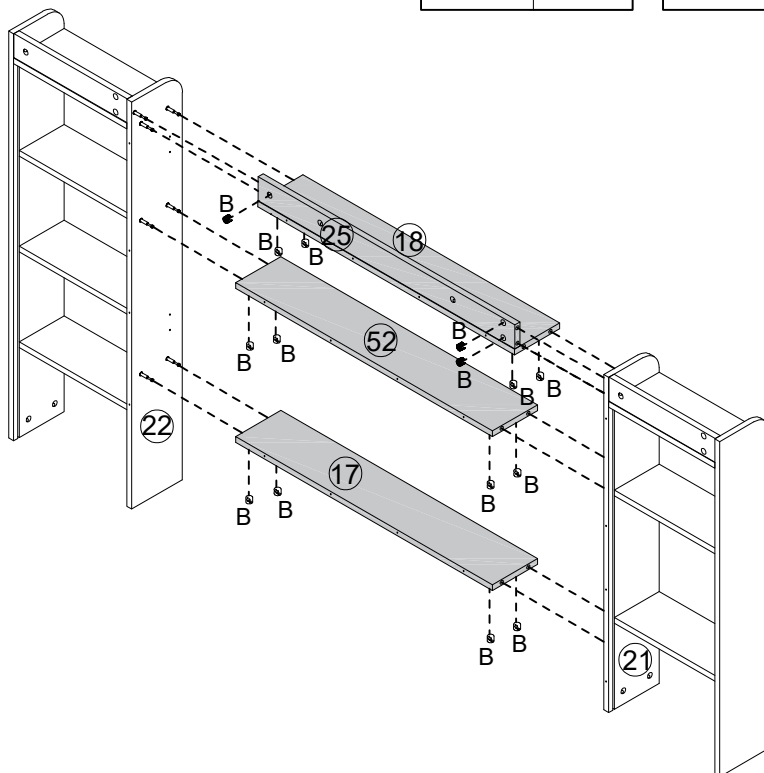
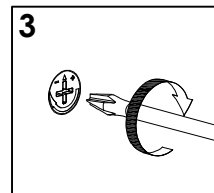
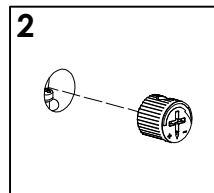
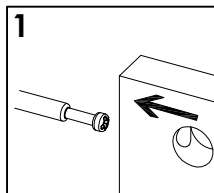
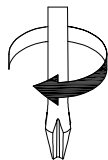

STEP35

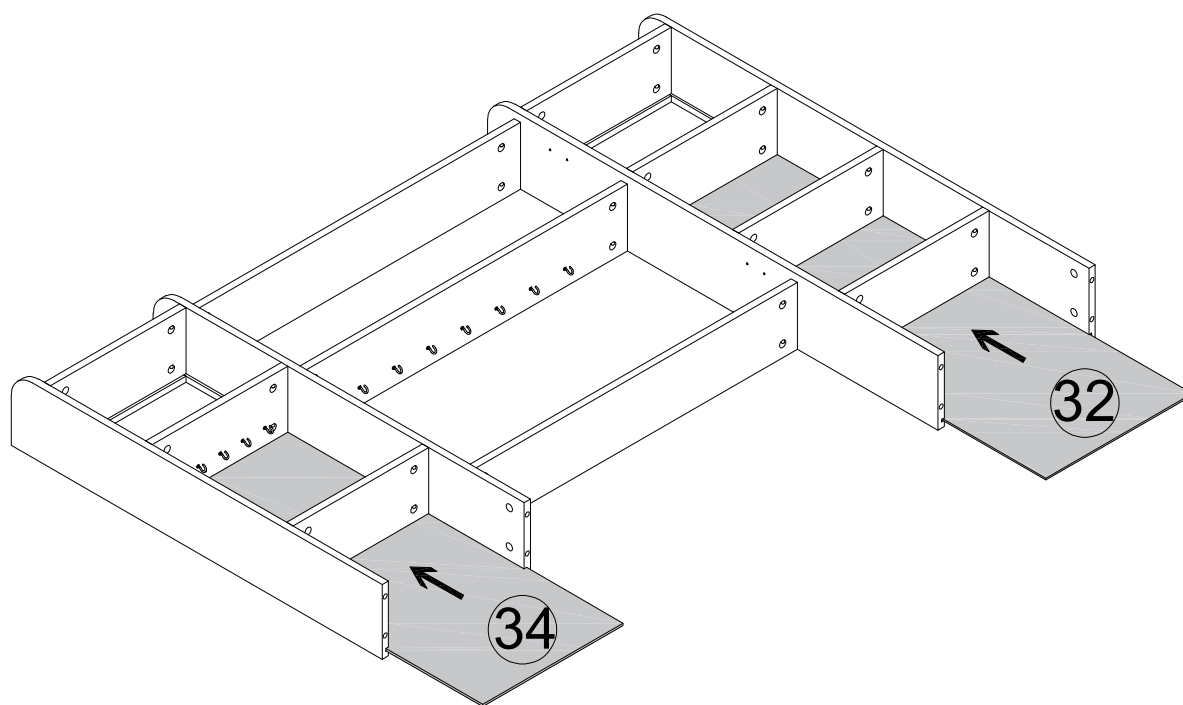

STEP36

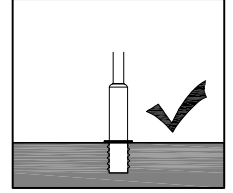
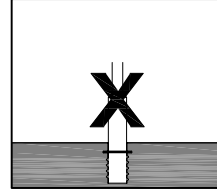
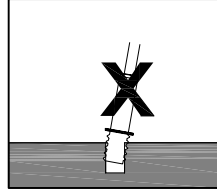
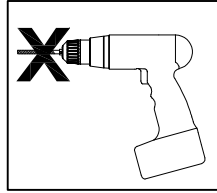

Iron Rod A is prohibited from using an electric drill.

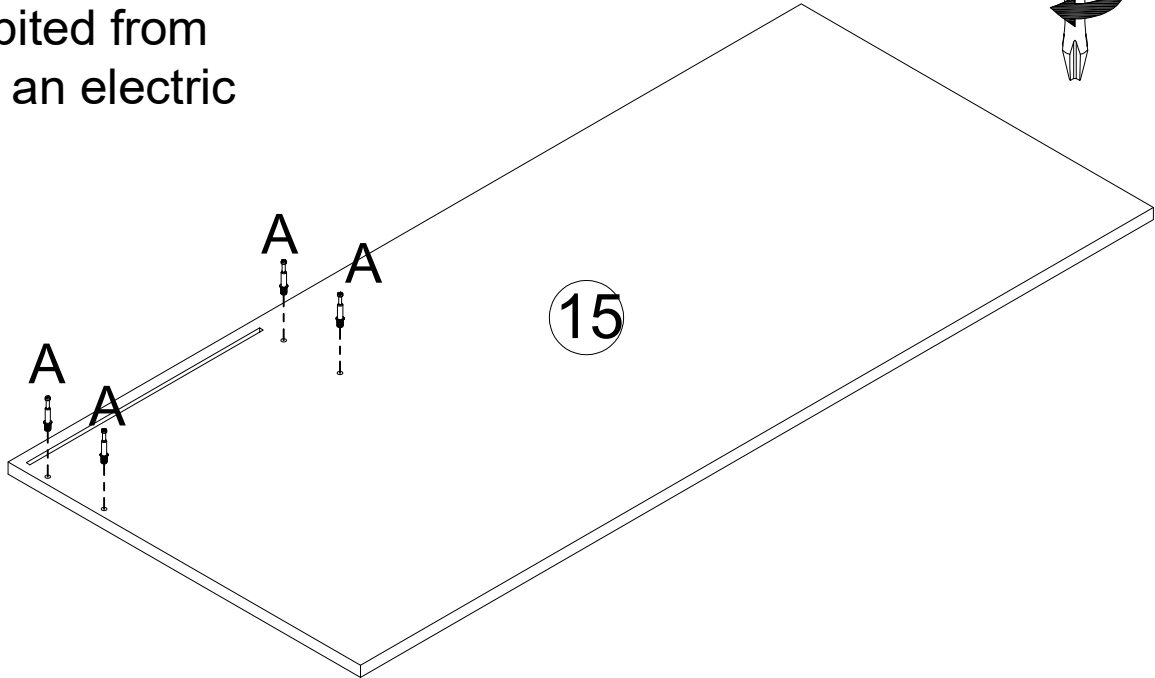
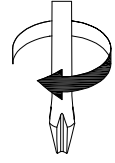

180°

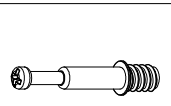
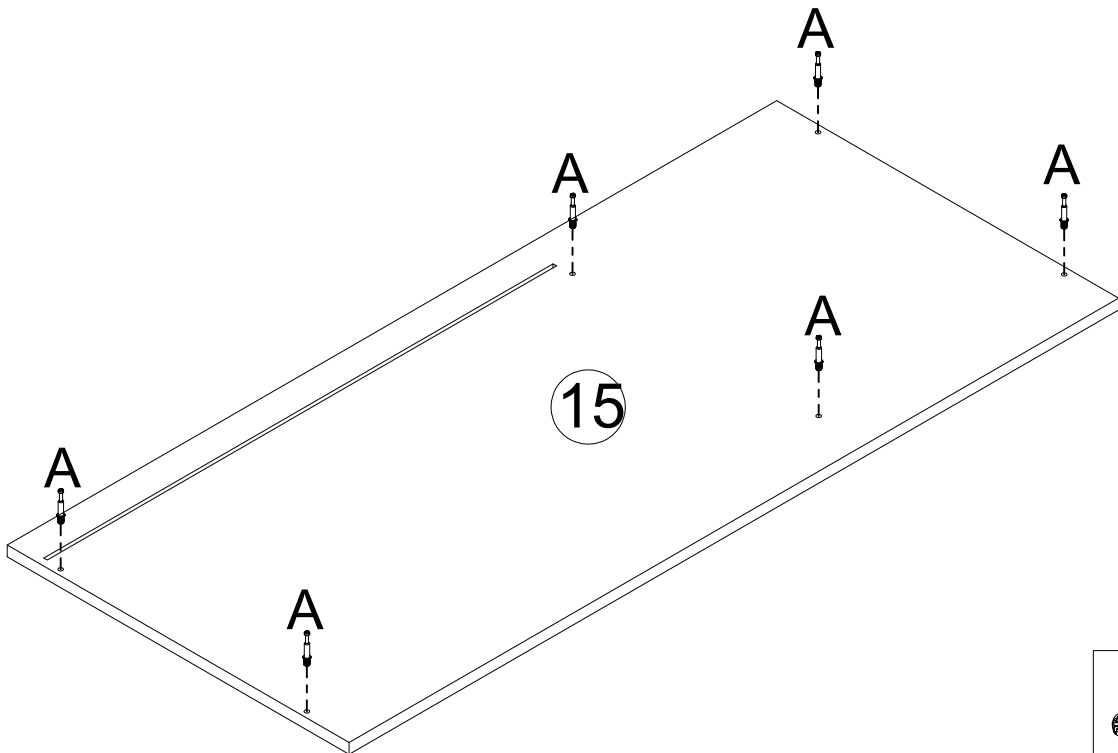

Ax10

STEP37

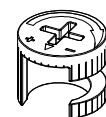
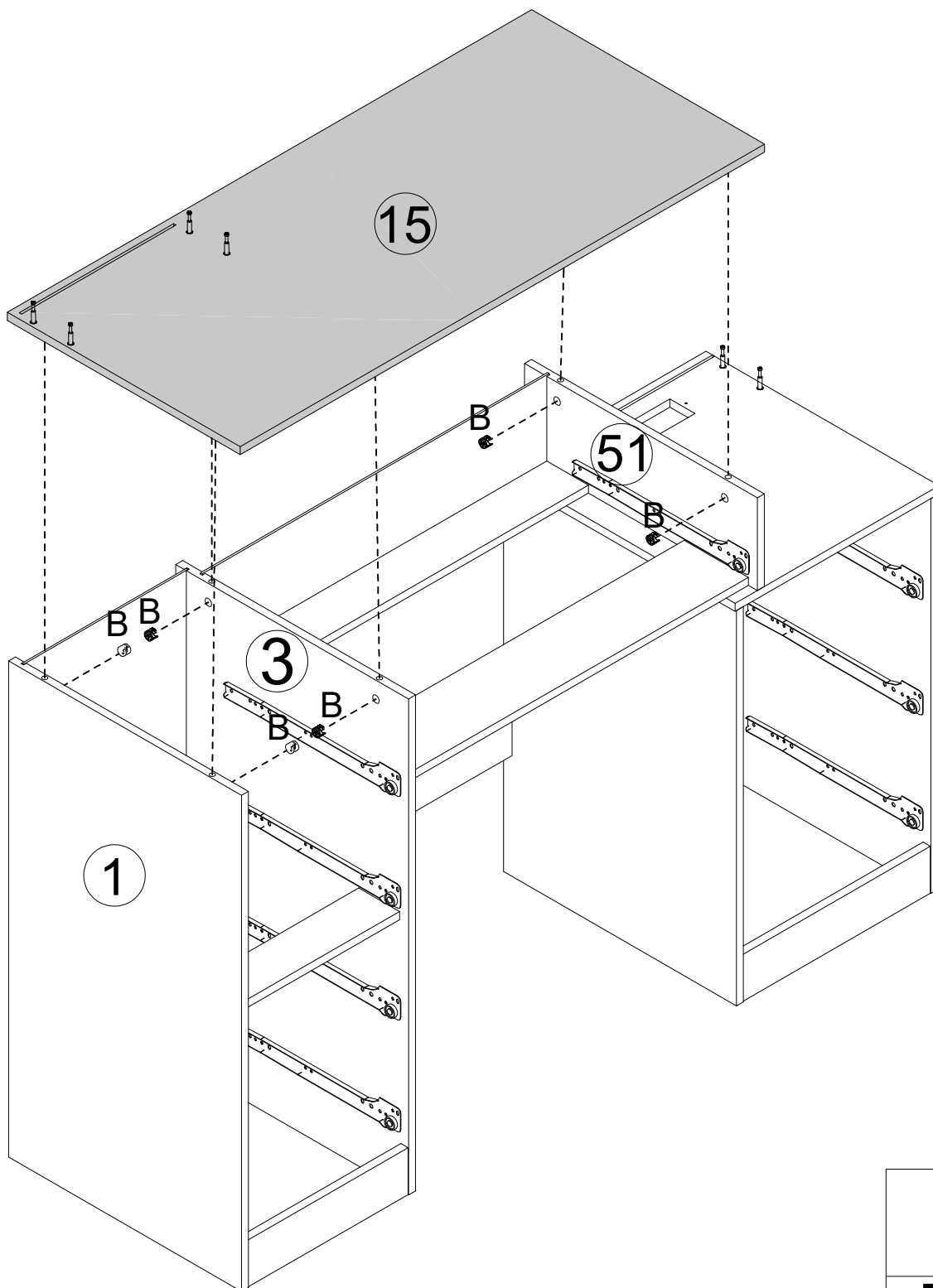
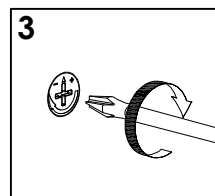
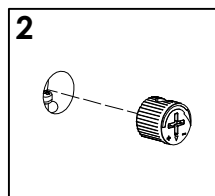
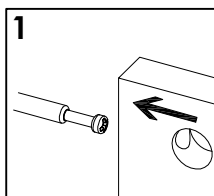
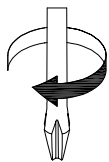

Bx6

STEP38

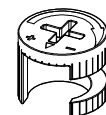
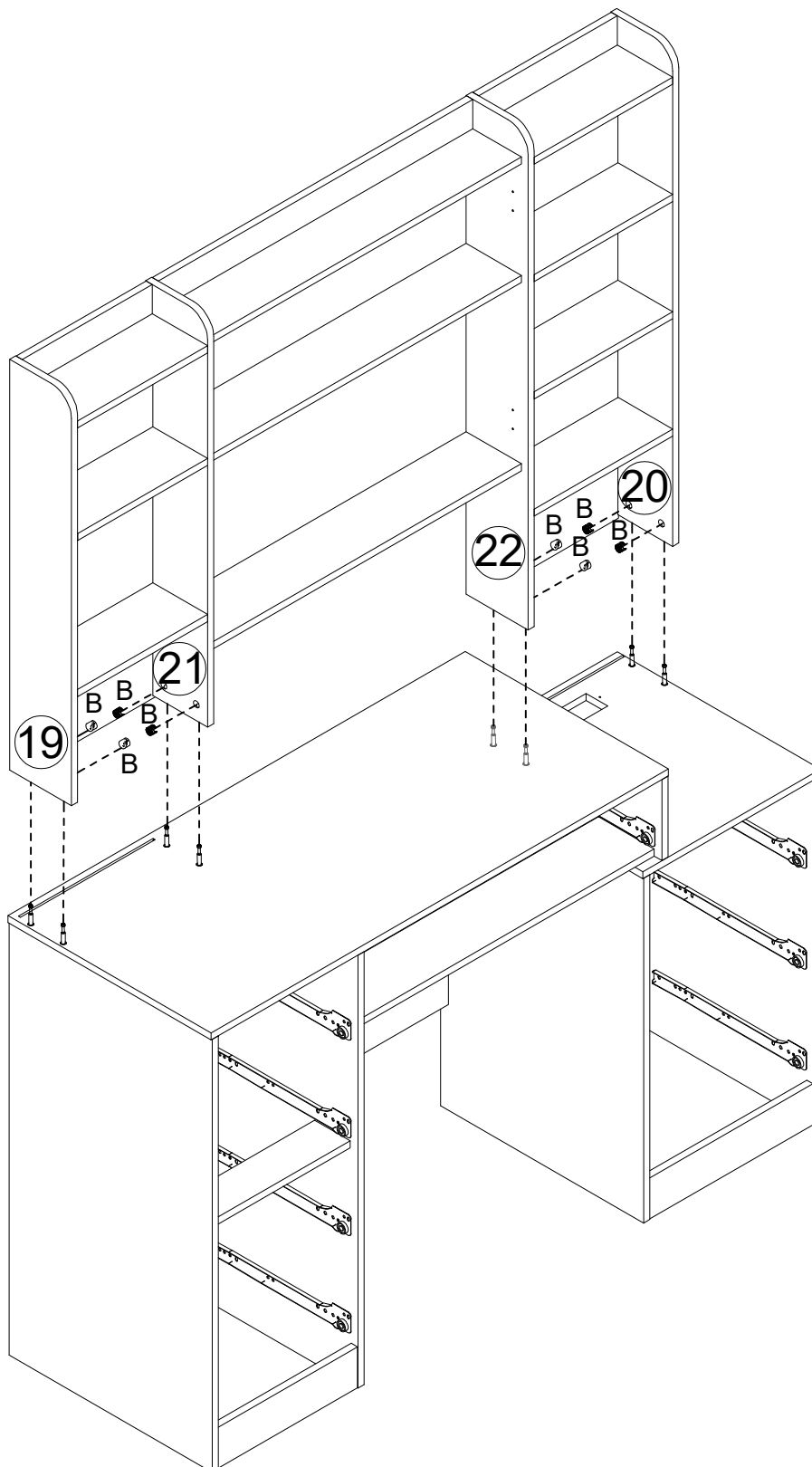
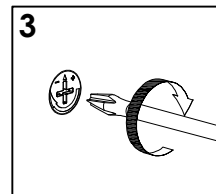
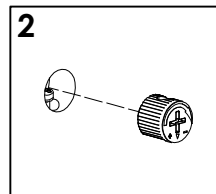
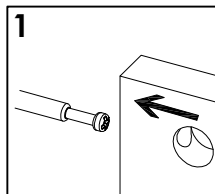
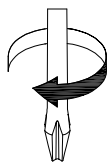

Bx8

STEP39

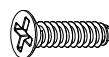
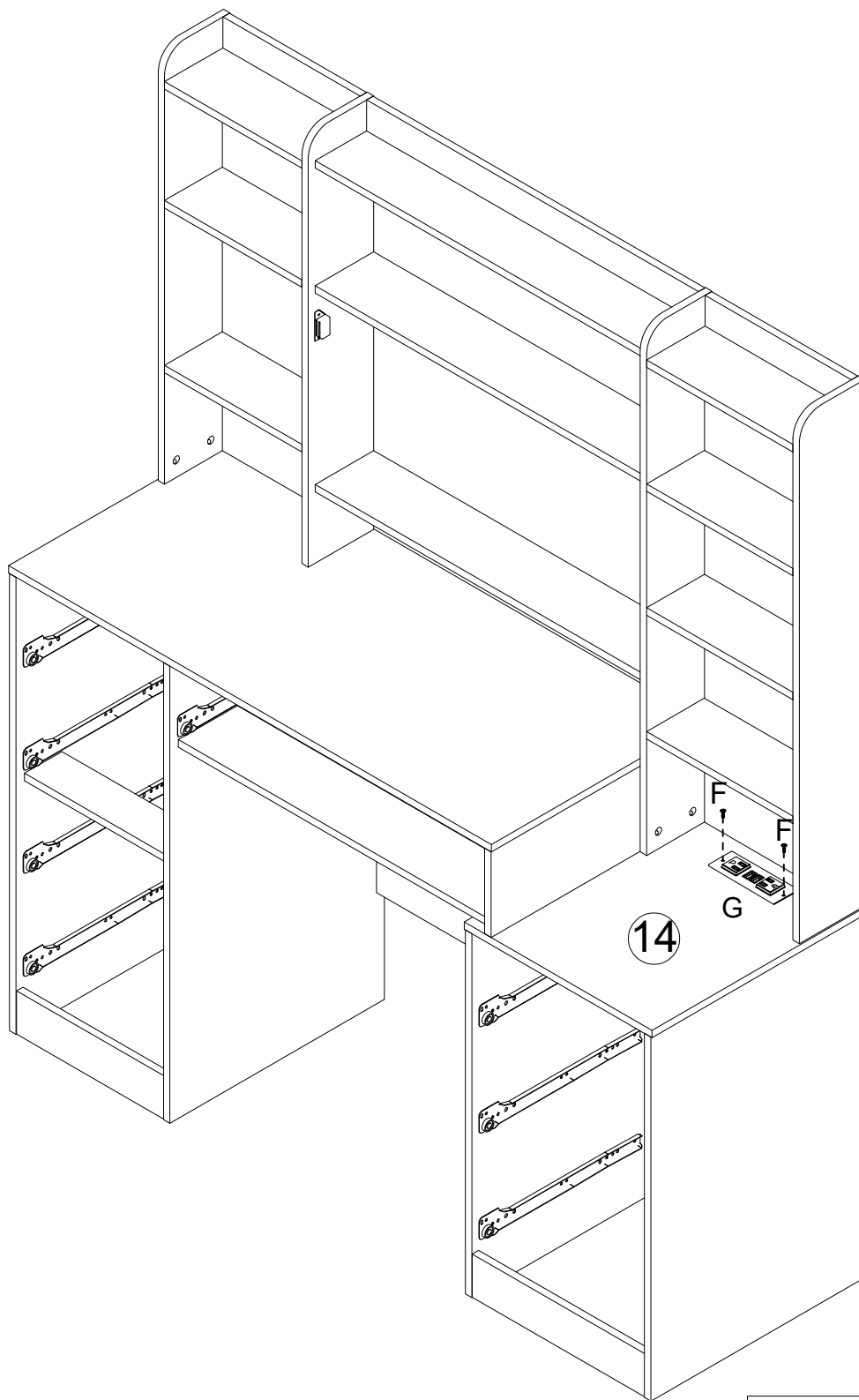

Fx2

Gx1

STEP40

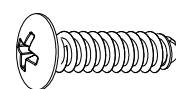
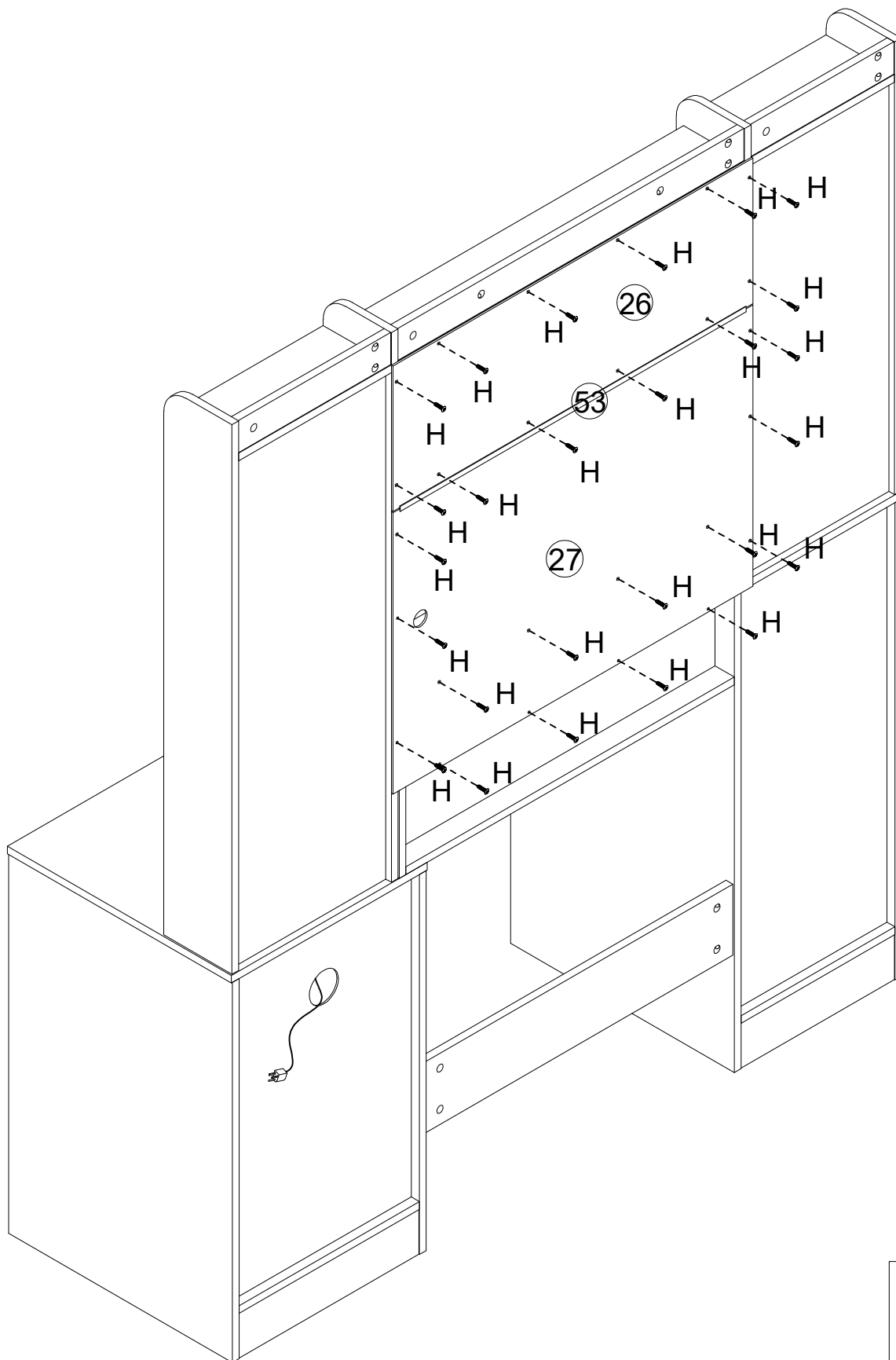
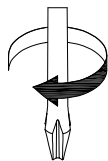

Hx26

STEP41

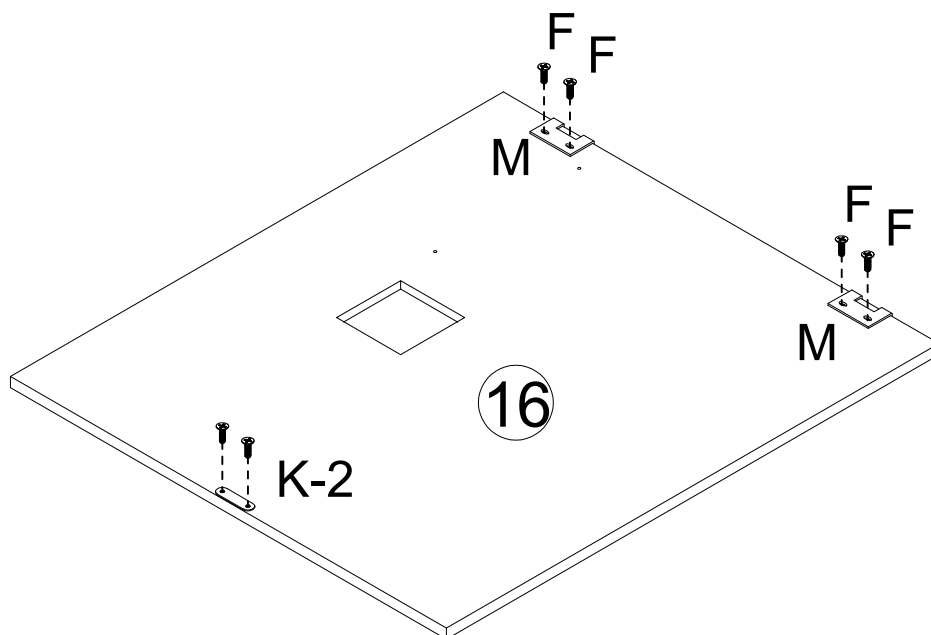
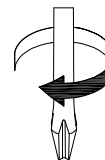

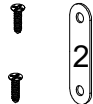
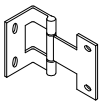
		
Fx4	K-2x1	Mx2

STEP42

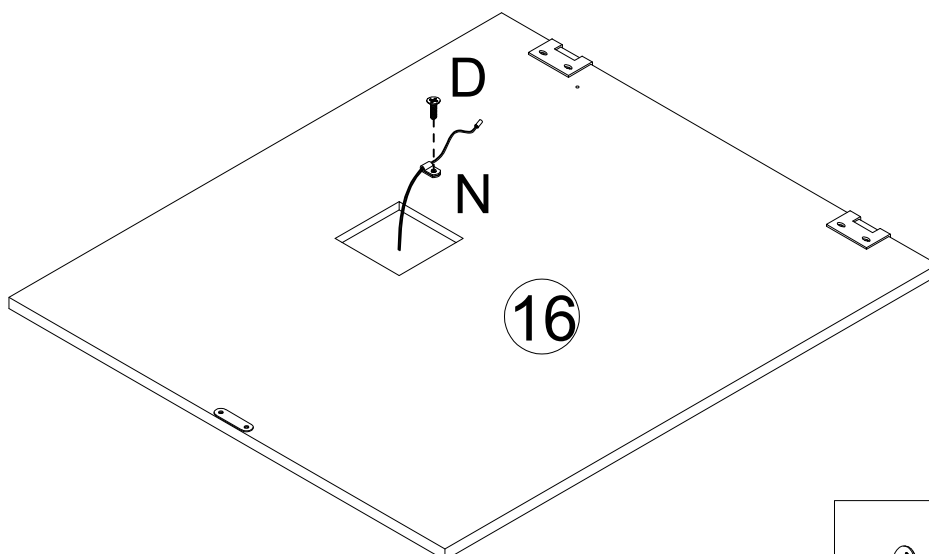

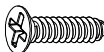
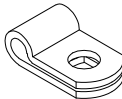

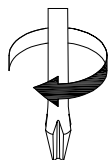

	
Dx1	Nx1

STEP43

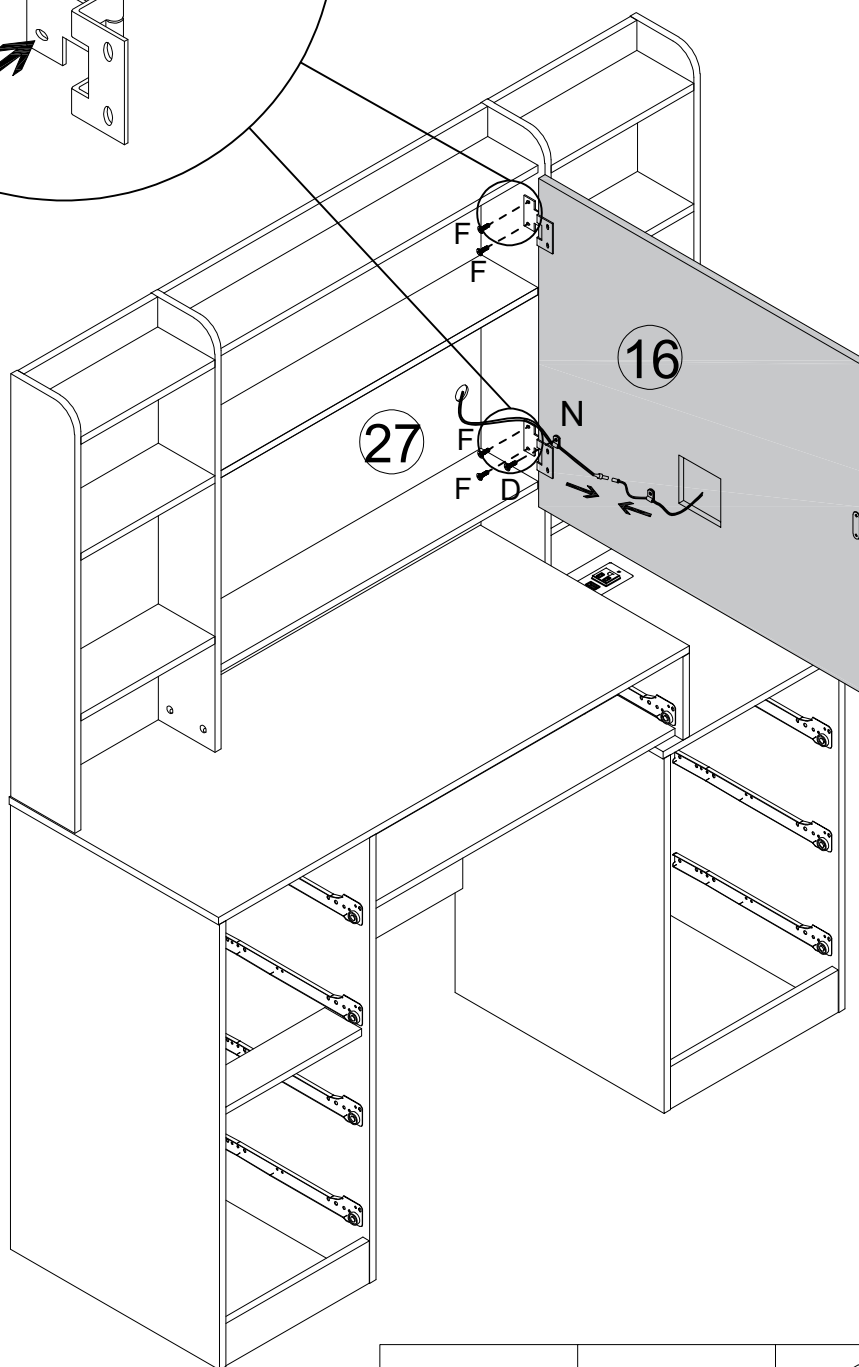
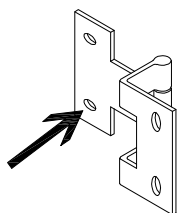

Adjusting the hole indicated on this hinge can move the mirror panel forward or backward.

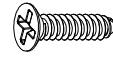
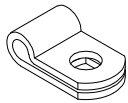

			
Dx1	Fx4	Nx1	x1

STEP44

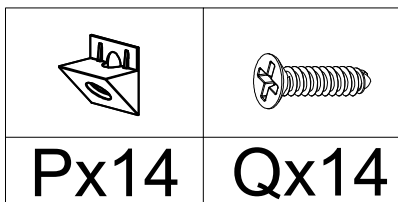
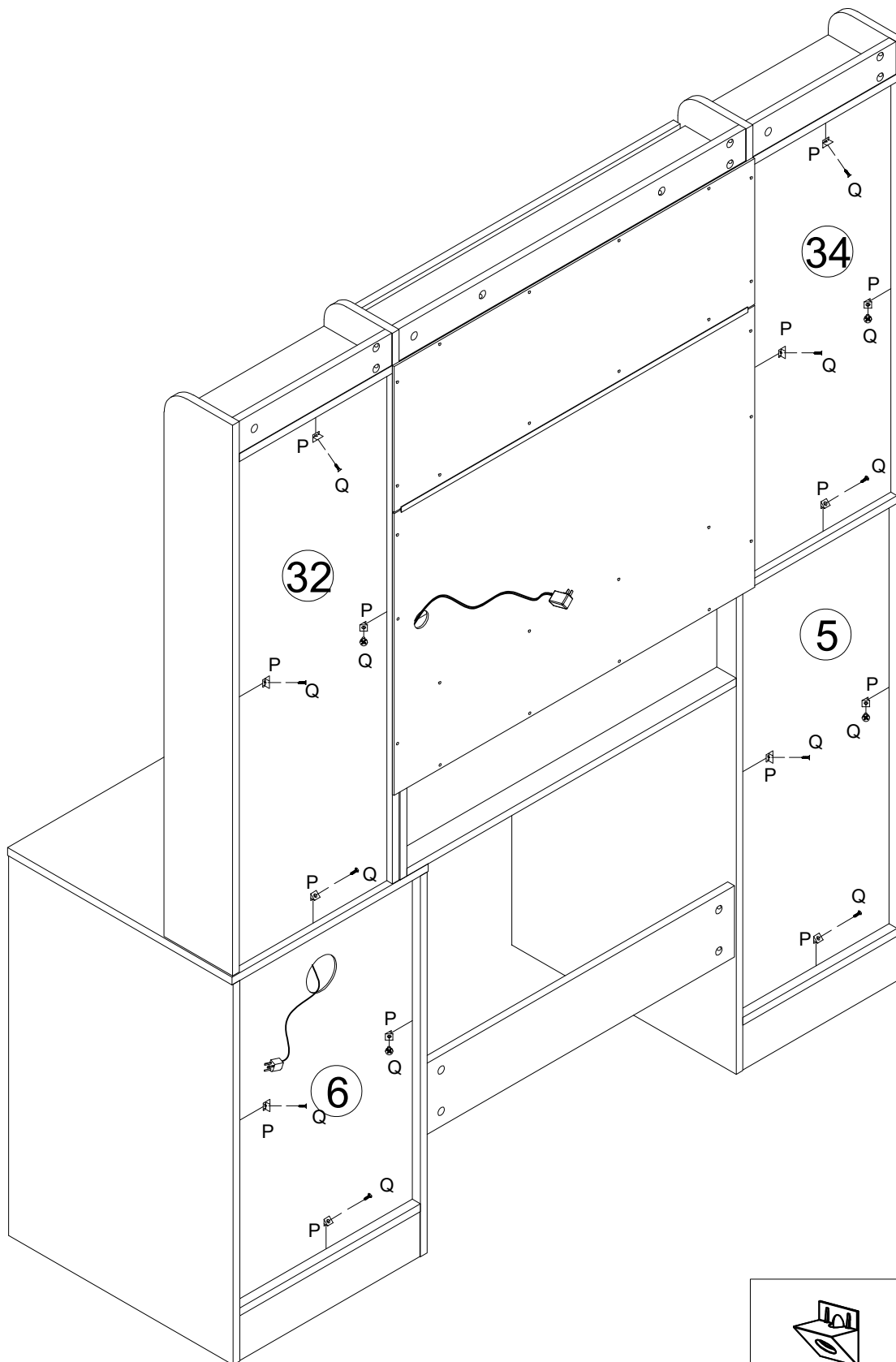
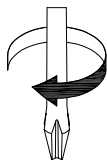

STEP45x4

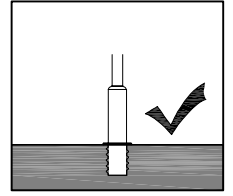
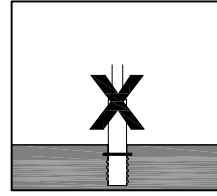
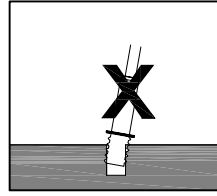
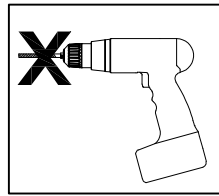

Iron Rod A is prohibited from using an electric drill.

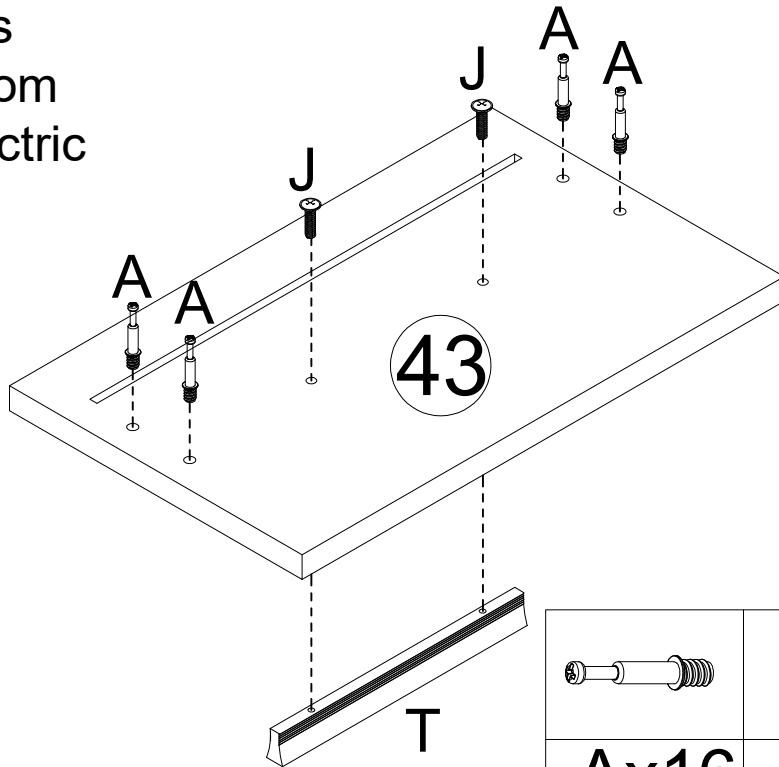

Ax16	Jx8	Tx4

STEP46x4

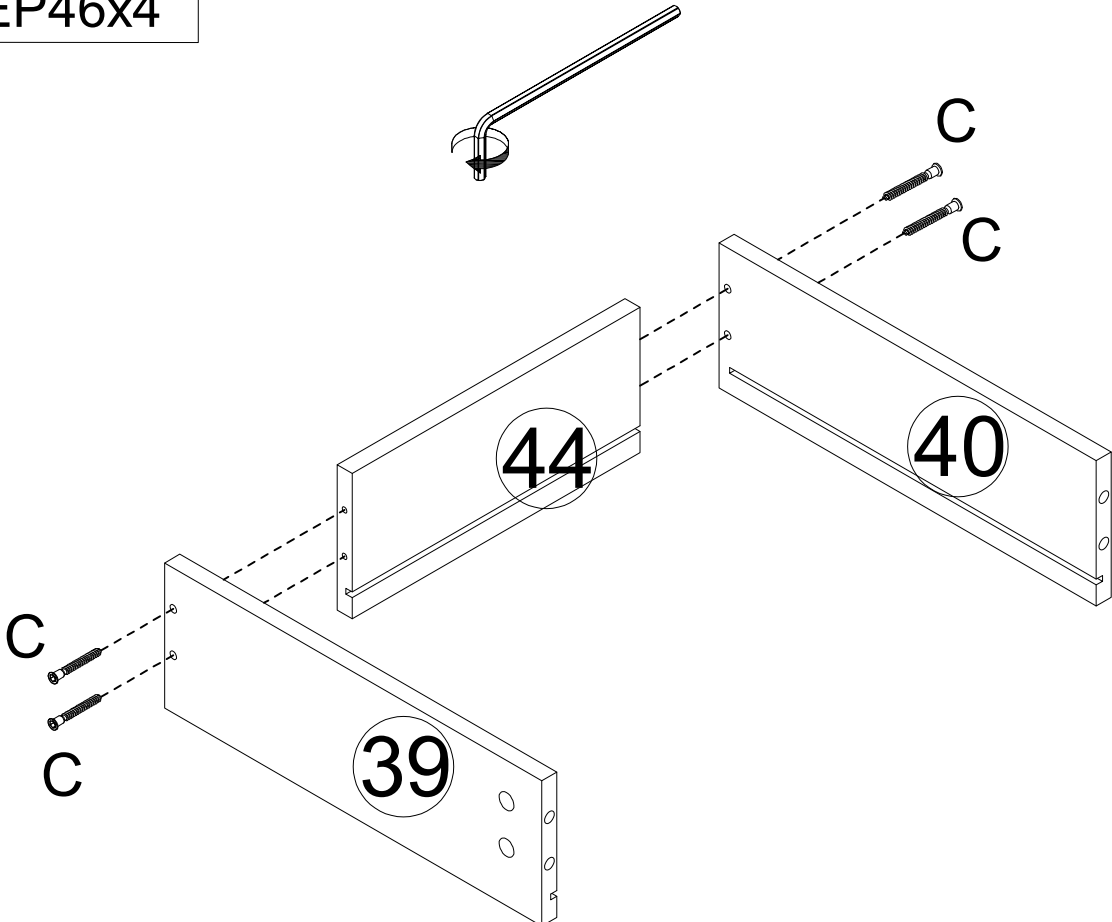

Cx16

STEP47x4

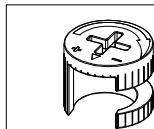
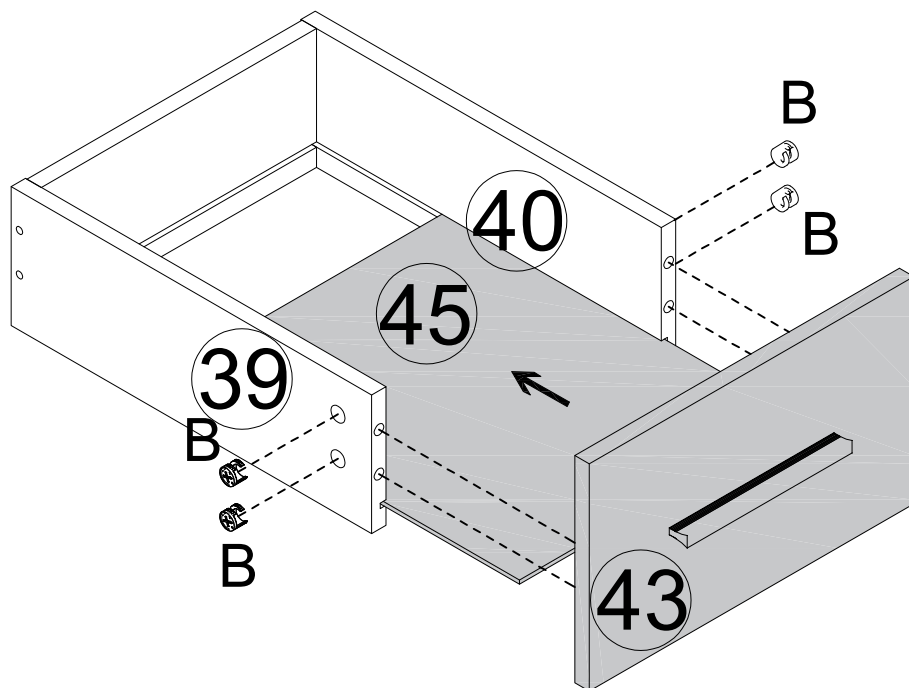
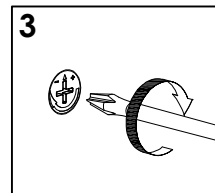
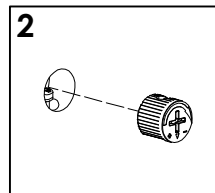
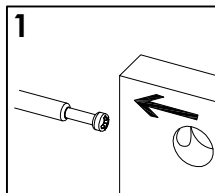
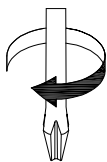

Bx16

STEP48x4

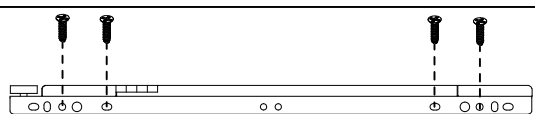
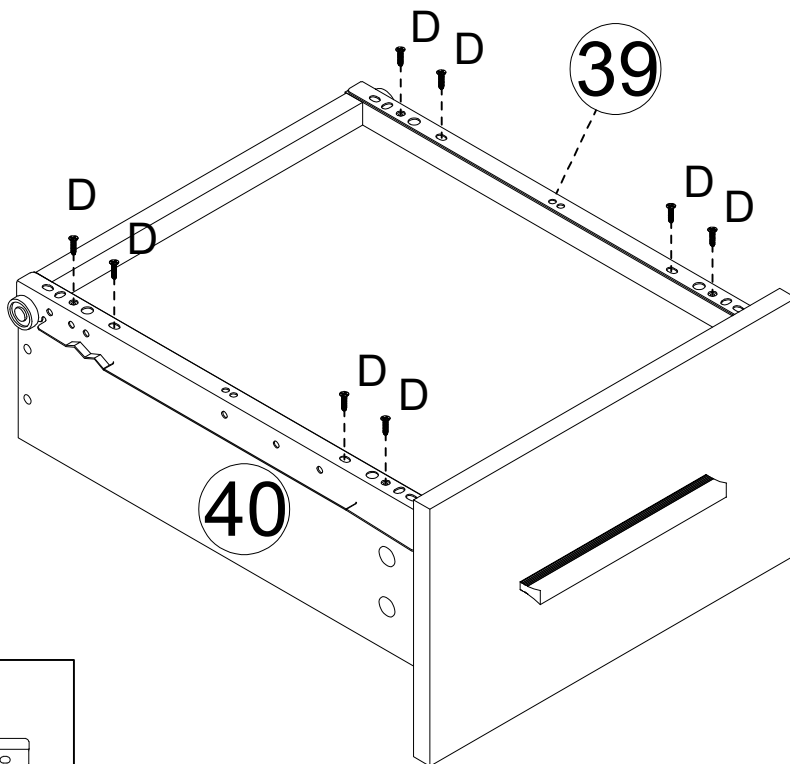
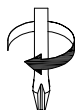

E-DLx4

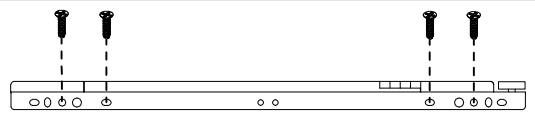

E-DRx4



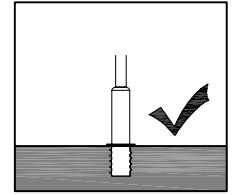
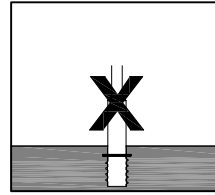
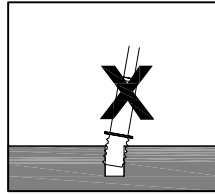
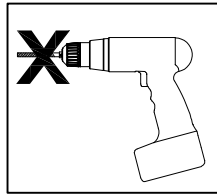

Dx32

STEP49x3



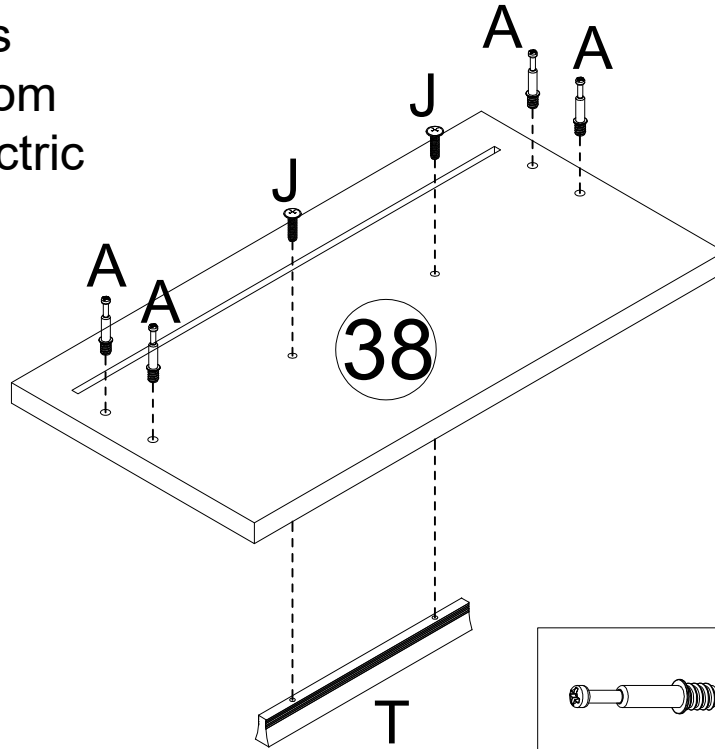

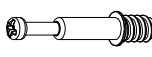
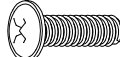
Iron Rod A is prohibited from using an electric drill.

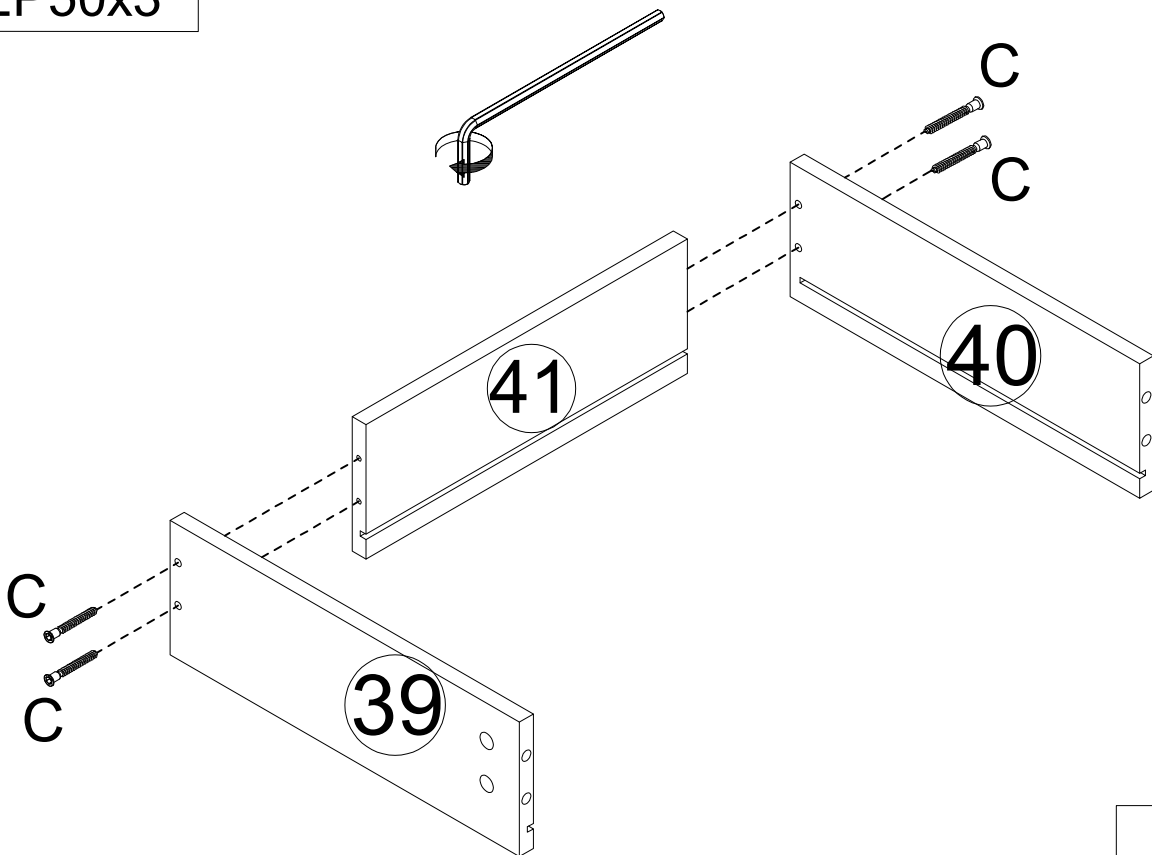

		
Ax12	Jx6	Tx3

STEP50x3



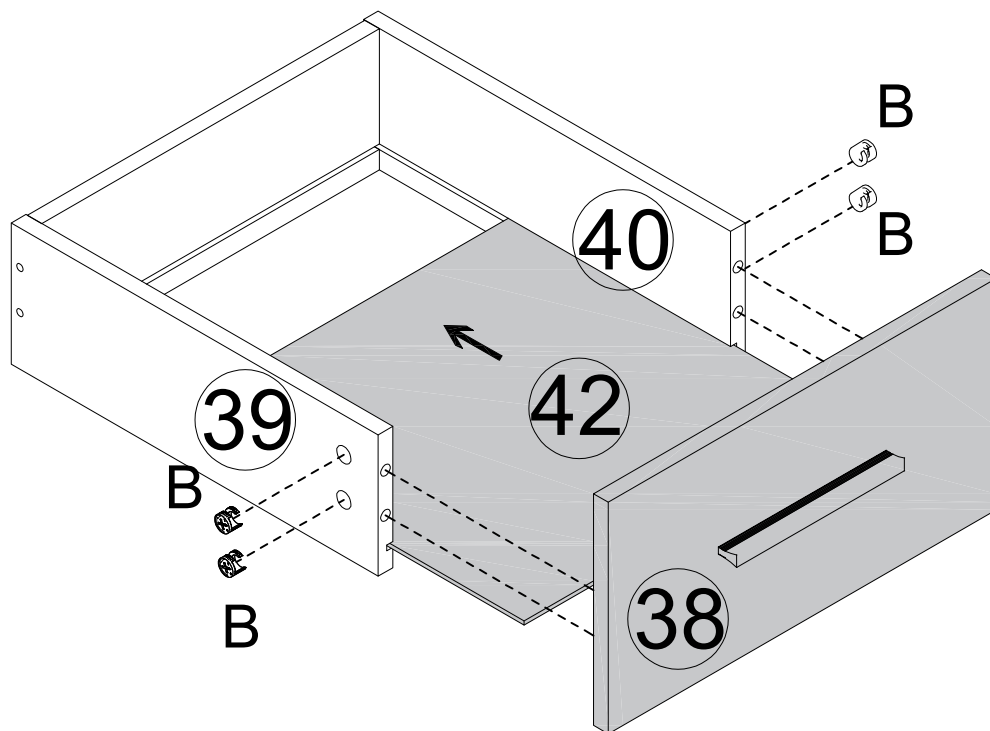
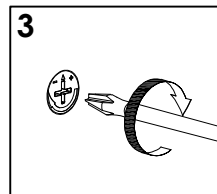
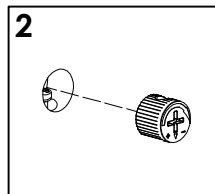
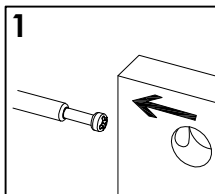
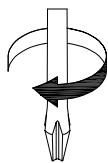

Cx12

STEP51x3

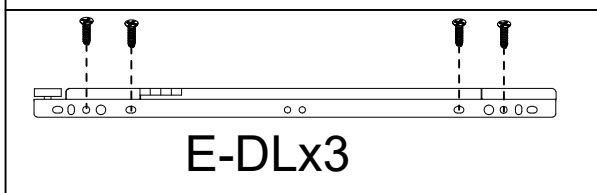
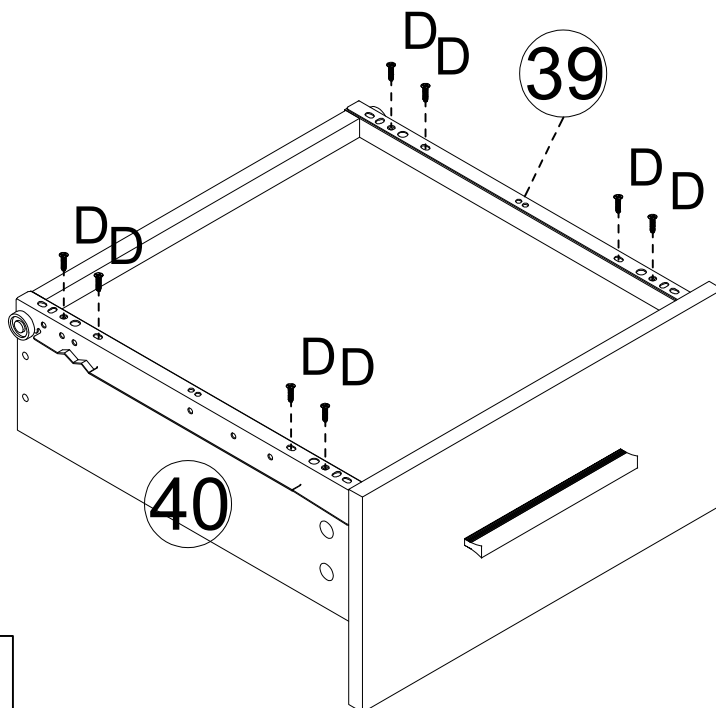

STEP52x3



E-DLx3



E-DRx3

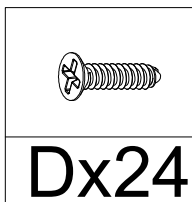

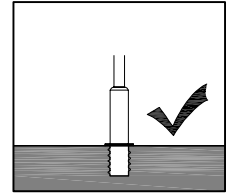
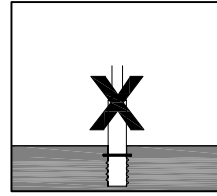
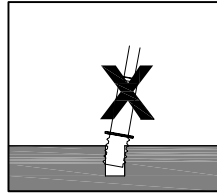
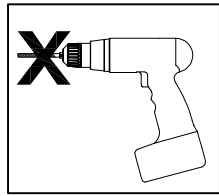

STEP53



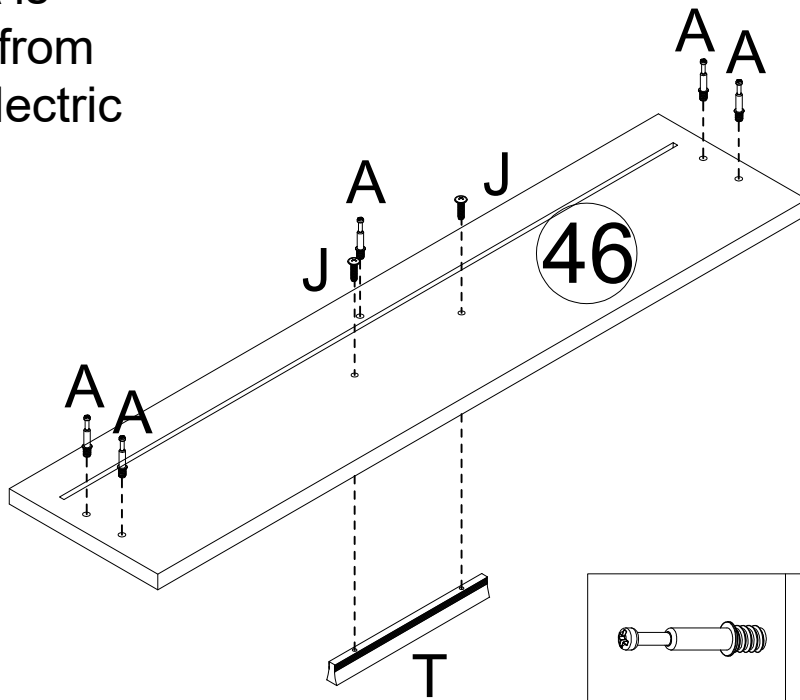

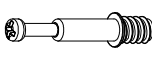
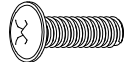
Iron Rod A is prohibited from using an electric drill.

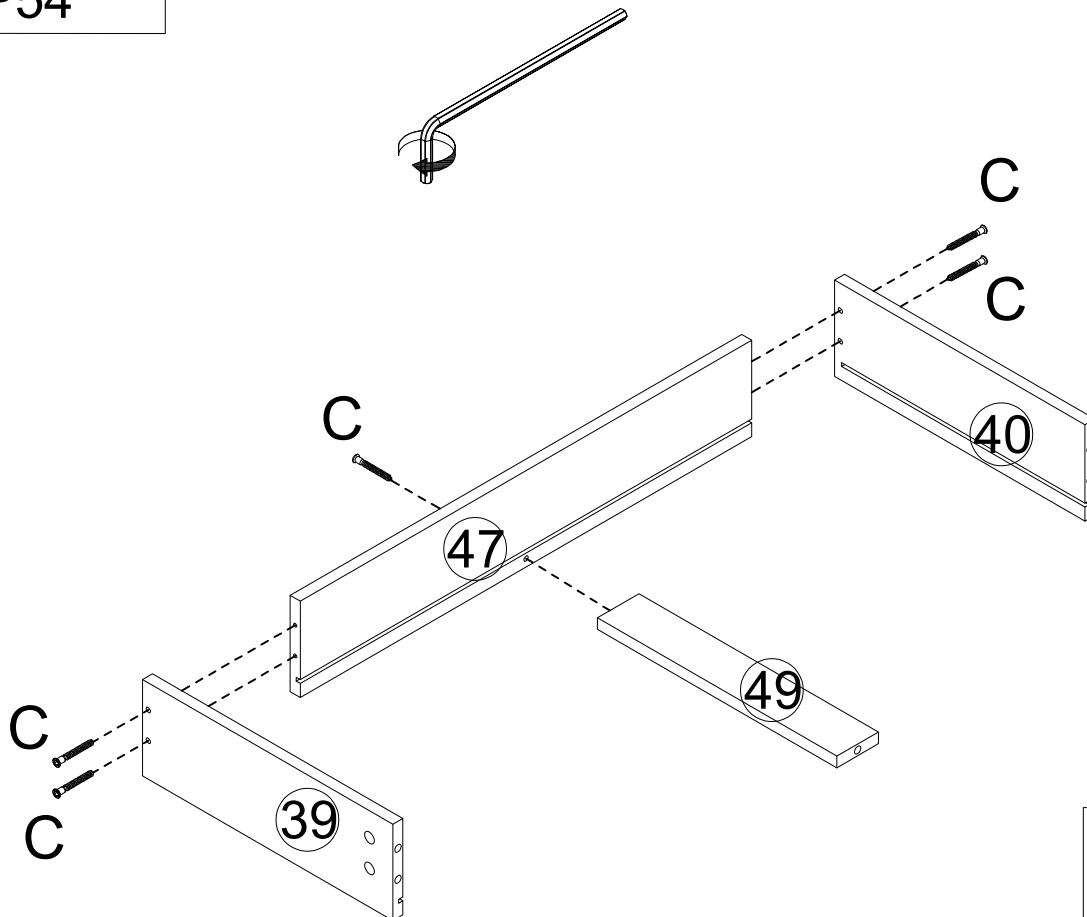

		
Ax5	Jx2	Tx1

STEP54



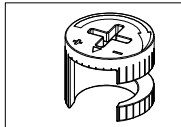
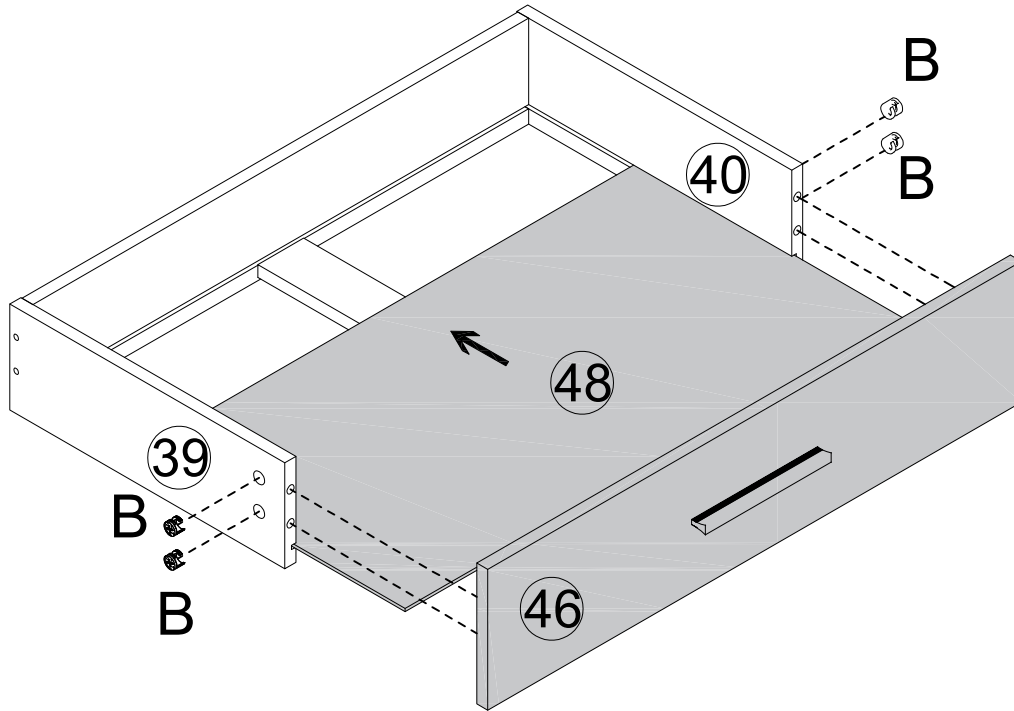
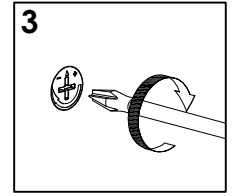
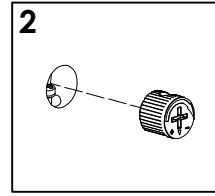
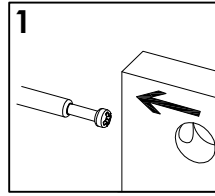
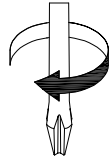

Cx5

STEP55

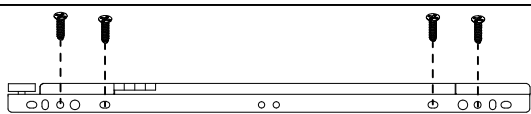
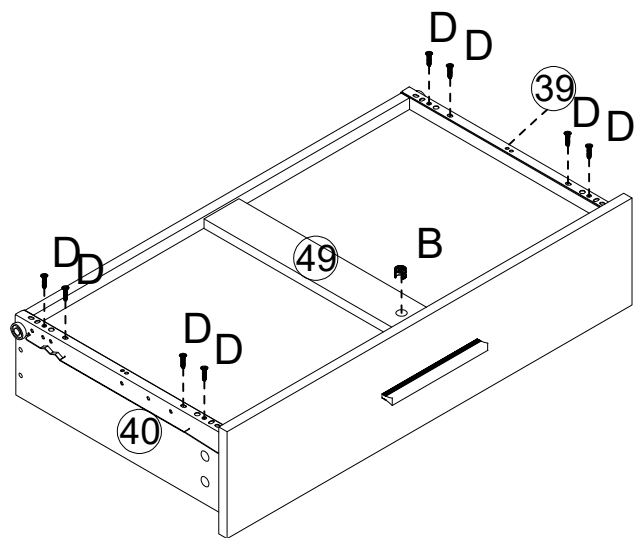
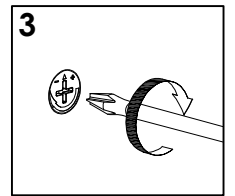
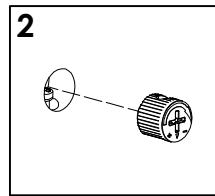
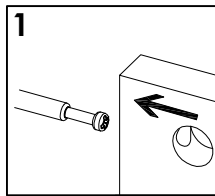
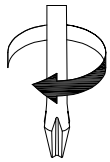

Bx4

STEP56



E-DLx1

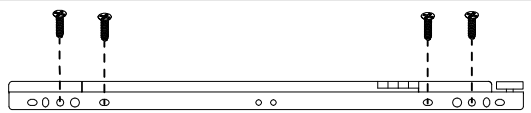

E-DRx1

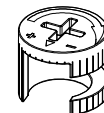

Bx1



Dx8

STEP 57

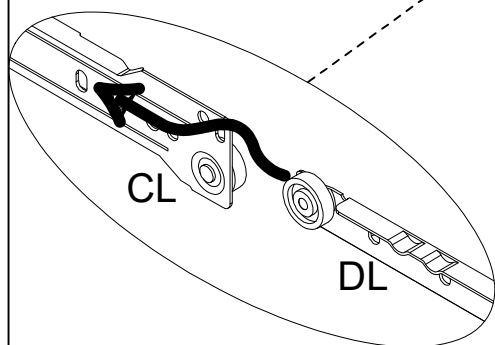
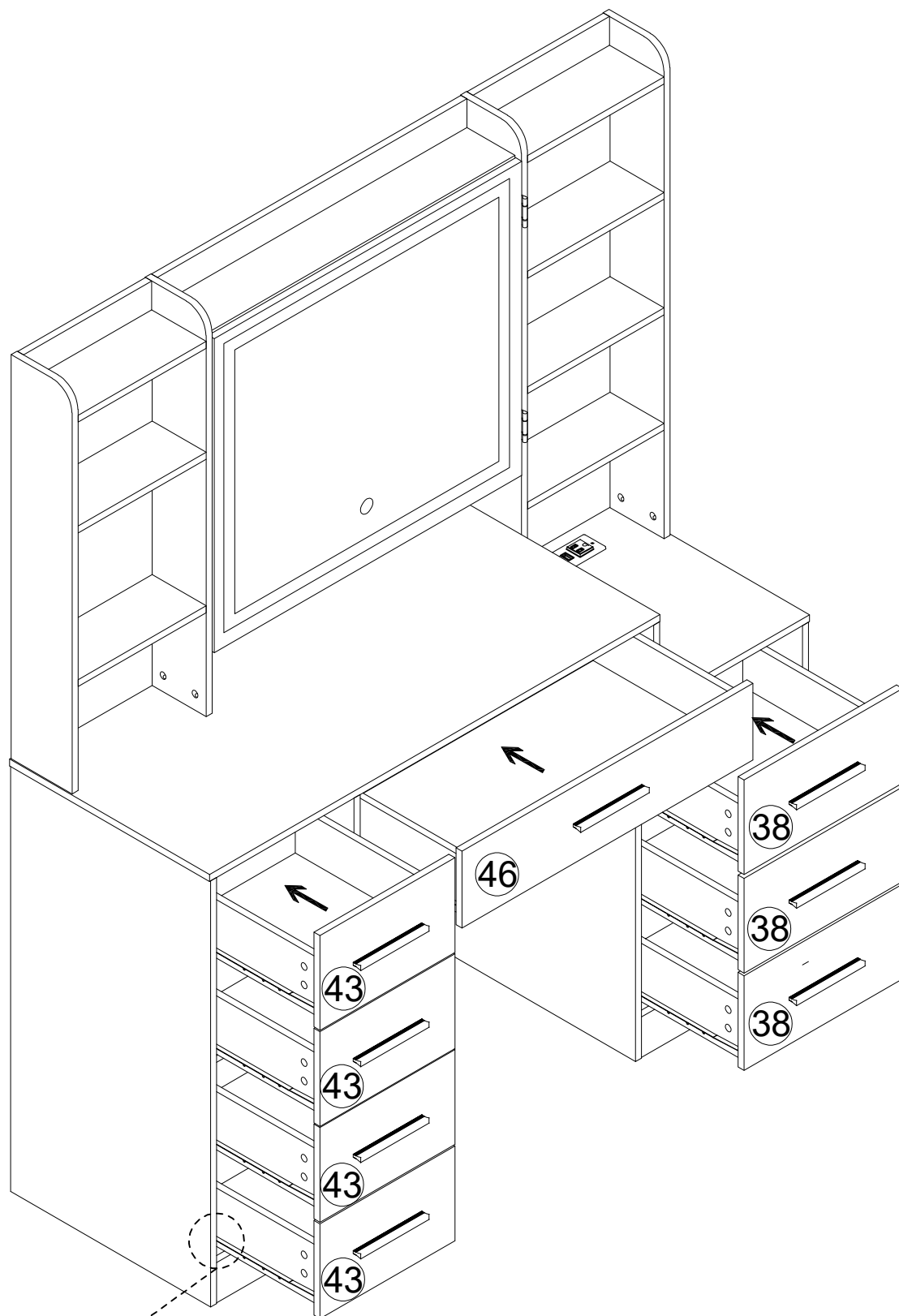

STEP58

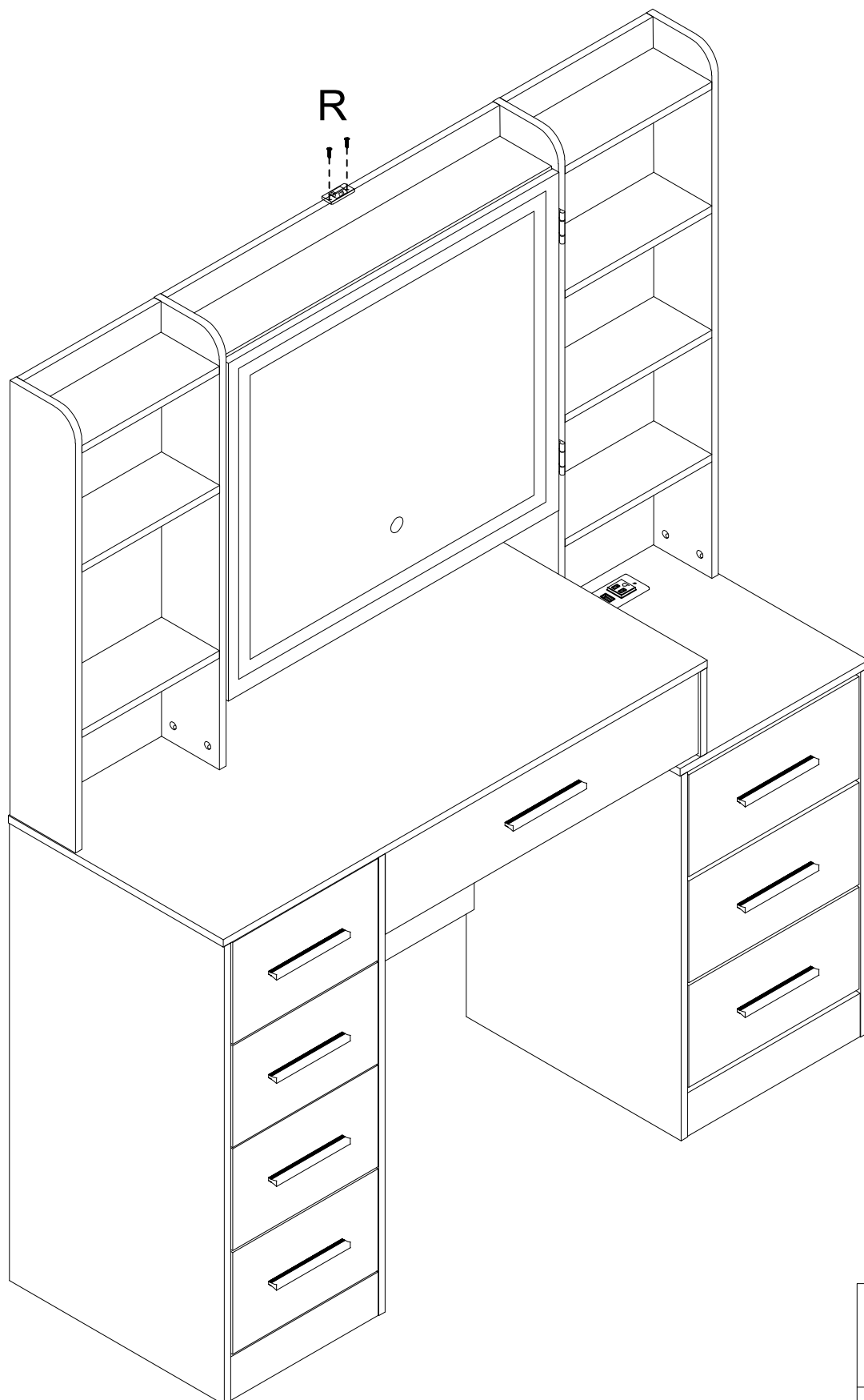
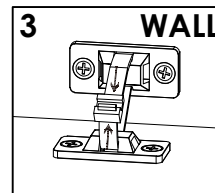
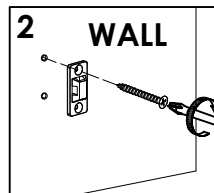
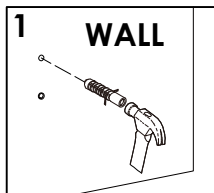
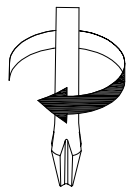

Rx1

STEP59

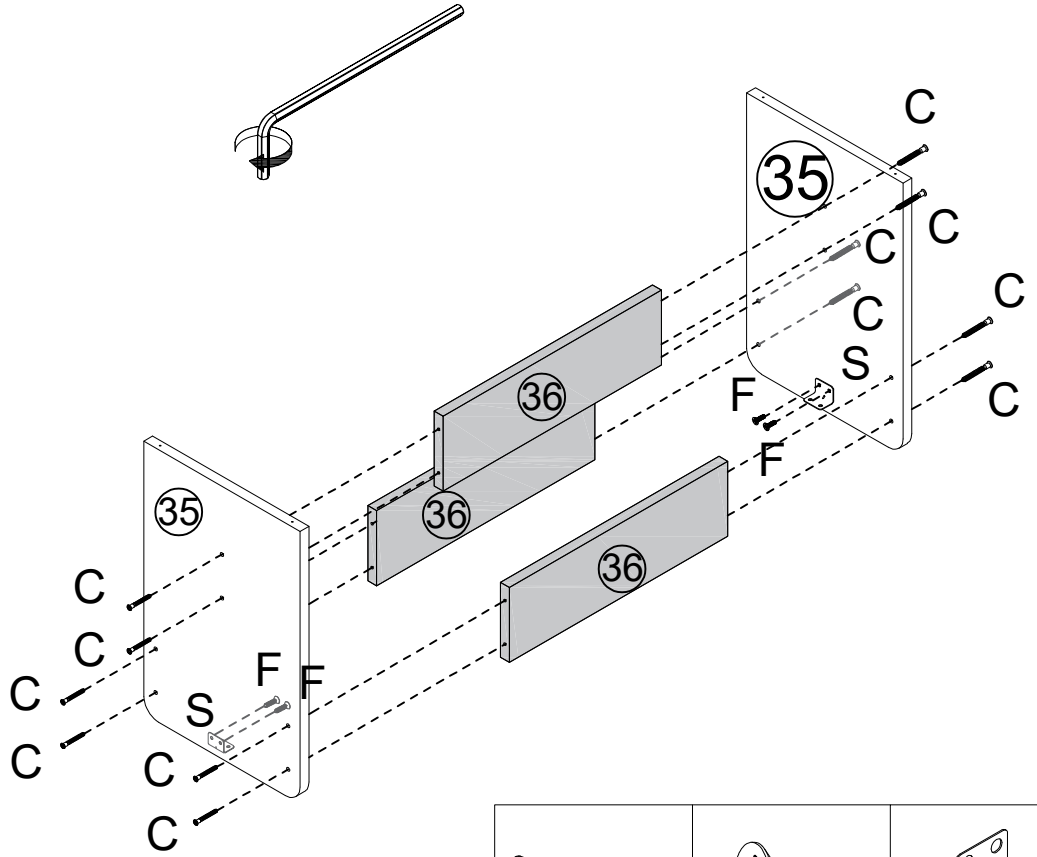
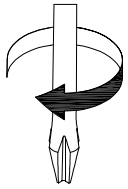

Cx12	Fx4	Sx2

STEP60

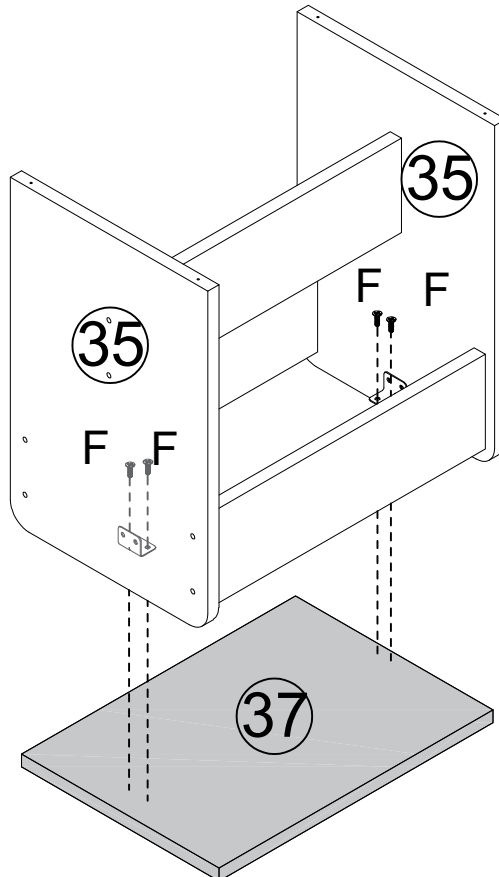
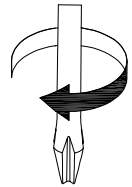

Fx4