

MBRR6030E

59.75" x 29.75" x 17.375"

Installation: Drop-In

Material: Acrylic

Plumbed Weight: 109 lbs / 50 kg

Soaker Weight: 85 lbs / 39 kg

Average Fill: 28 gal to above jet level

Maximum Fill: 46 gal to overflow

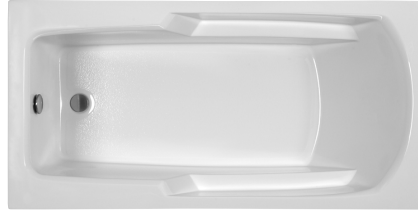

Package	Package Content	Part #
Soaker	Soaking bath - No jets. Includes textured bottom.	MBSRR6030E
Air Bath	12 air jets, heated air blower, pre-leveled foam base and textured bottom. <i>pre-leveled foam base increases overall tub height 2"-3"</i>	MBARR6030E
Whirlpool	6 point-massage jets, 1-bhp pump and textured bottom	MBWRR6030E

Options *Must be ordered at time of purchase.*

Standard White (no charge)
Color Upgrade: Biscuit (MTISCOLOR)

Quick Ship / Priority
Soaker & Whirlpool (QSHIPMTIS)
Airbath (QSHIPMTISA)

Inline Heater
For Whirlpool (HTRMTIS) uses existing pump For Soaker & Air Bath (MBHTISOAK) heater with recirculating pump

Accessories.

Lift and Turn Drain & Overflow
Chrome (MBWOC), White (MWOW),
Brushed Nickel (MBWOBN)

Pillows
Soft Pillow
White (MBPSW) Black (MBPSB)
Roll-Up Pillow
Light Aqua (MBPRUC) Black (MBRUB)

Installation Options. *Must be ordered at time of purchase.*

Tile Flange
Factory-Installed rigid ABS
3 sides (MBTFK3), 2 sides (MBTFK2),
1 side (MBTFK1)
Must specify flange location(s) on order.

Pre-Leveled Foam Base
5' Tubs (MBPLFOAM)
5.5' & 6' Tubs (MBPLFOAM2)
All airbaths include a pre-leveled foam base.

Pre-Leveled Foam Base
5' Tubs (MBPLFOAM)
5.5' & 6' Tubs (MBPLFOAM2)
All airbaths include a pre-leveled foam base.

Pre-Leveled Frame and Foam Base with Skirting
Raised Fixed Panel
5' Tubs (MBFSKAO5), 5.5' Tubs (MBFSKAO55),
6' Tubs (MBFSKAO6)
Raised Removable Panels
5' Tubs (MBFSKAR5), 5.5' Tubs (MBFSKAR55),
6' Tubs (MBFSKAR6)

Shown with Whirlpool Package

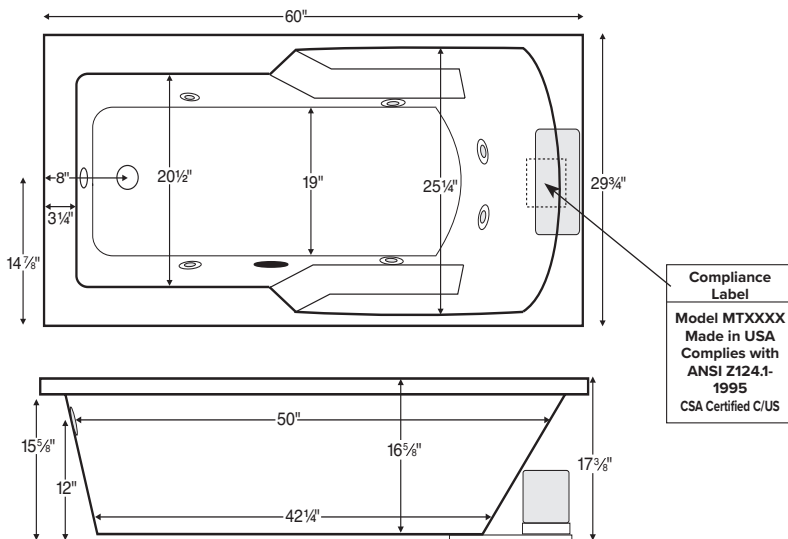

Important Ordering and Installation Information

- Before ordering or installing, consider access to equipment.
- Always measure tub on-site before building tub deck.
- Use proper bedding compound to fully level and support the tub.
- Tubs equipped with an air system or factory installed pre-leveled foam base are designed to install directly onto a flat level subfloor.
- Tub height is increased up to 3" when equipped with factory-installed foam base.
- Location of all therapy components is predetermined and cannot be changed.
- Options listed cannot be combined with Designer Collection options.

- Before discarding tub crate, check for accessories that may be packaged inside.
- All product measurements are ±1/2".
- Specifications and configurations are subject to change without notice.
- Measurements herein supersede all others published prior to publication date below.

CSA # MTIS-RR6030E
Effective 030121

Hydrotherapy Package	Components Included	GFCI / 110V
Soaker with Optional Inline Heater	½-bhp pump, inline heater	1-15 amp
Whirlpool or Air Bath	1-bhp pump	1-15 amp
Whirlpool with Optional Inline Heater	1-bhp pump, inline heater	1-20 amp
Air Bath with Optional Inline Heater	heated blower, ½-bhp pump, inline heater	2-15 amp

CSA Certified C/US; ANSI Z124.1 and ANSI 112.19.7

NOTE: *Filling this tub to the maximum may require an above average size or dedicated water heater.*

