

11

ASSEMBLY GUIDE

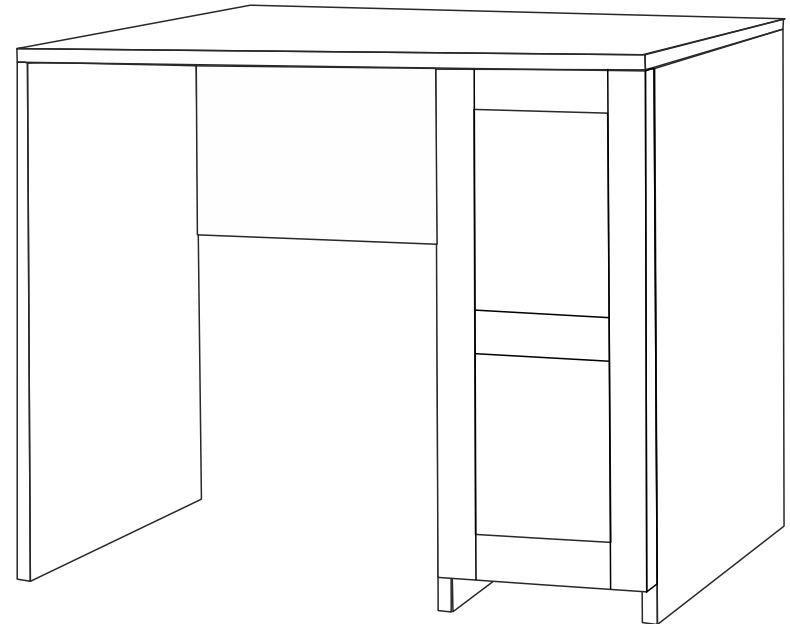

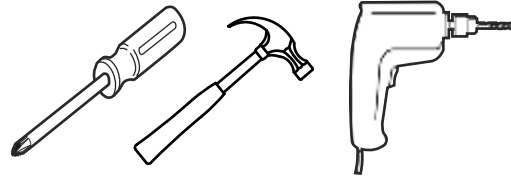

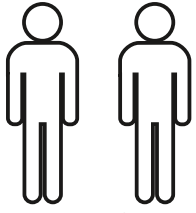





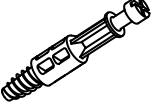

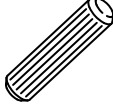

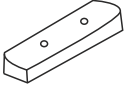
Bu modül iki kişi tarafından kurulmalıdır.
This unit should be assembled by two persons.

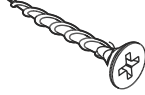
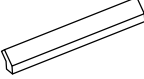
Bu modülün kurulumu için gerekli olan araçlar.
The necessary tools (not included)

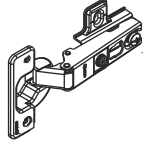
AKSESUAR LİSTESİ / ACCESSORY LIST

| | | | |
|--|--|--|--|
|  |  |  |  |
| MİNİFİX MİL x 14 (MİNİFİX SHAFT) | MİNİFİX GÖVDE x 14 (MİNİFİX BODY) | KAVELA X 14 (DOWEL) | DÜBEL X 14 (PEG) |
|  |  |  |  |
| AYAK PAPUÇ X 6 (FURNİTURE LEG) | 3.5X18 VİDA X 24 (3,5X18 SCREW) | 3.5X40 VİDA X 2 (3,5X40 SCREW) | AHŞAP KULP X 1 (HOLDER) |
|  |  |  | |
| ARKALIK KÖŞE X 4 (CORNER WEDGE) | DÜZ MENTEŞE X 2 (HINGE) | RAF PİMİ X 4 (PİLASTIC PIN) | |

* AKSESUARLARI GÖSTERİLDİĞİ GİBİ DÜZ BİR ZEMİN ÜZERİNDE TAKINIZ...
* ÜRÜNÜ KURARKEN MONTAJ SIRASINI TAKİP EDİNİZ

* FIX THE ACCESSORIES AS SHOWN FOLLOW THE
INSTALLATION SEQUENCE WHILE INSTALLING THE PRODUCT.

1

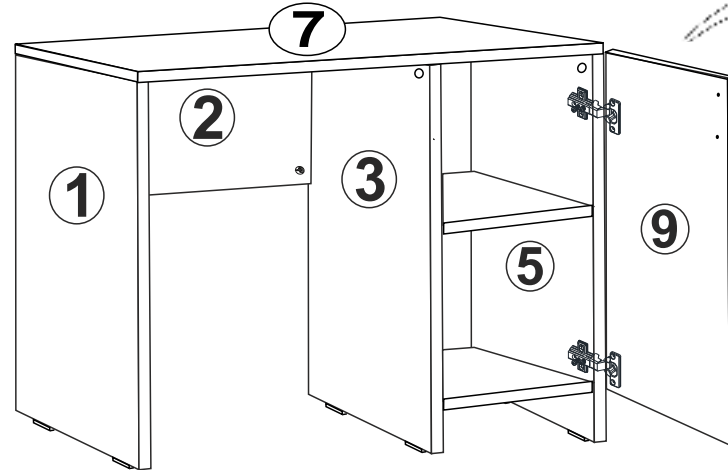
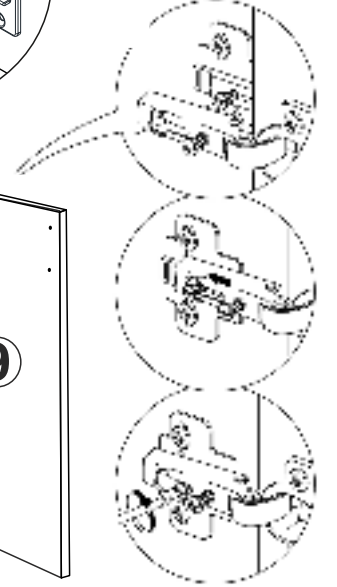
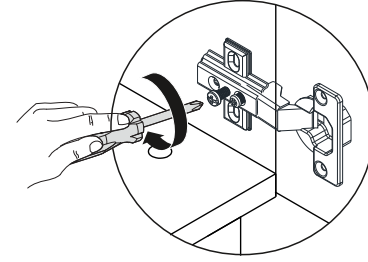
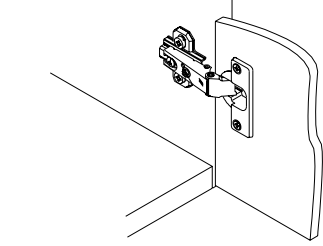

10

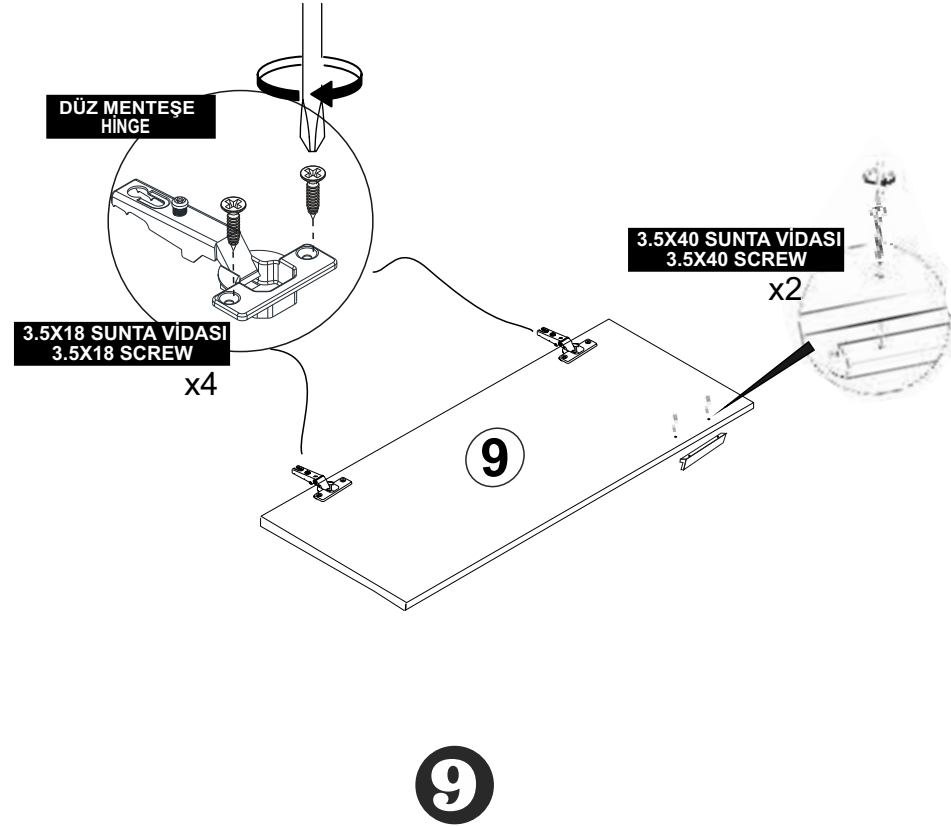
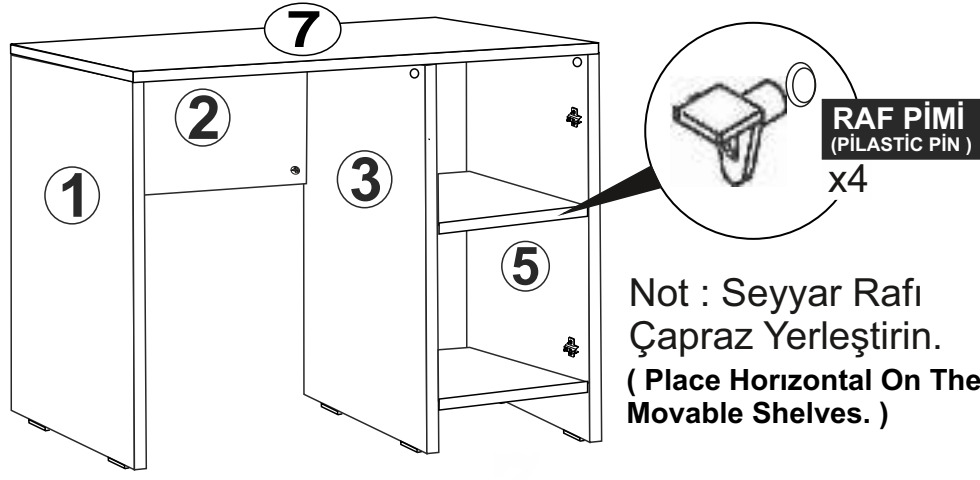

DİKKAT !! / ATTENTION !!

Minifiks ve Kavela ürünlerimizde kullanılan ana bağlantı malzemesidir. Montaja başlamadan önce lütfen aşağıdaki çizimleri kontrol ederek, anlamaya çalışın...

Minifix and Dowel is the main connection material used in products. Before starting assembly, please check the drawings below...

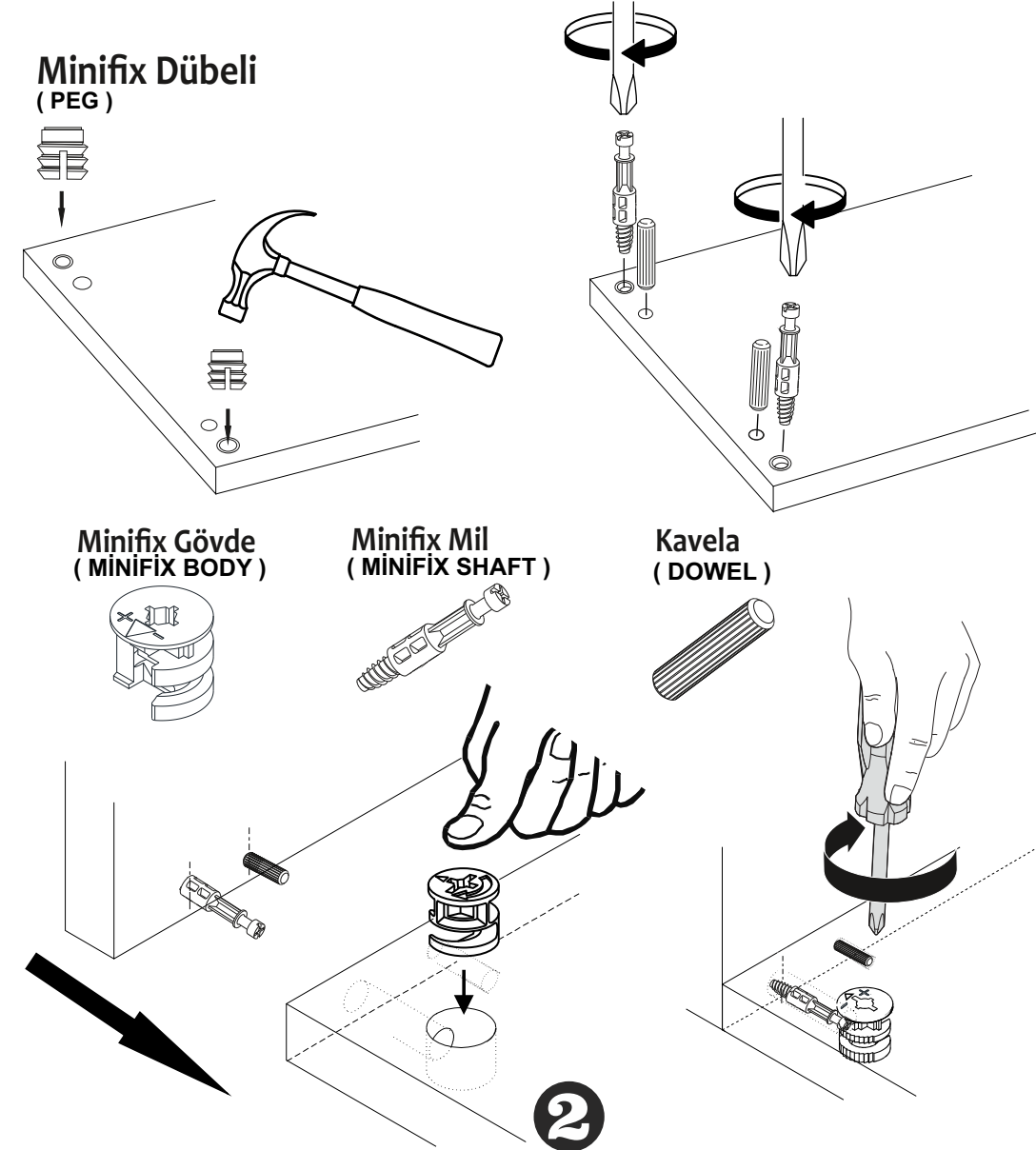

PARÇA KODLAMA / GENERAL VIEW

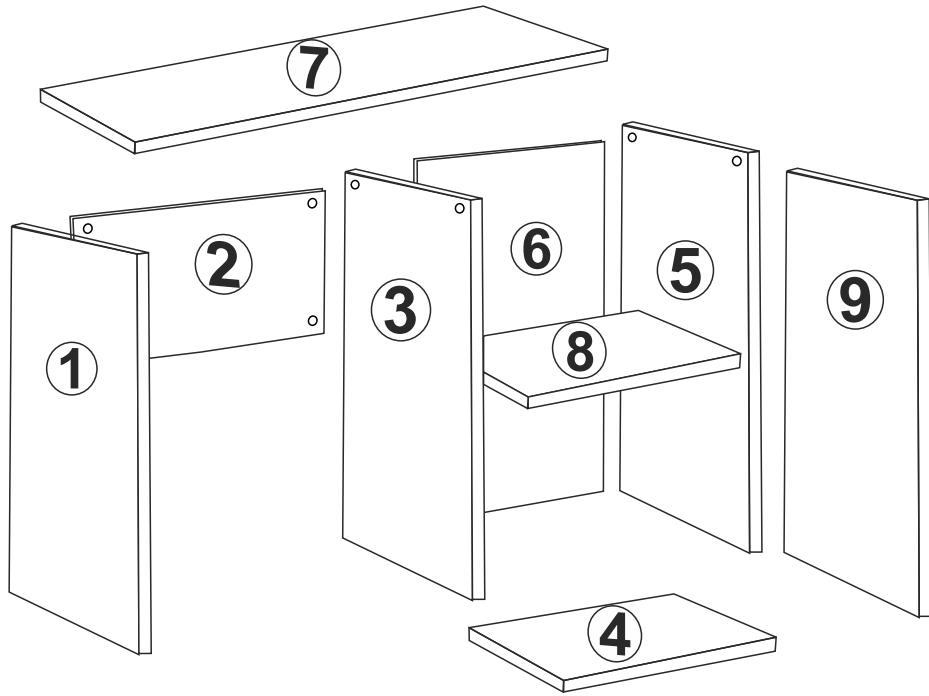

3

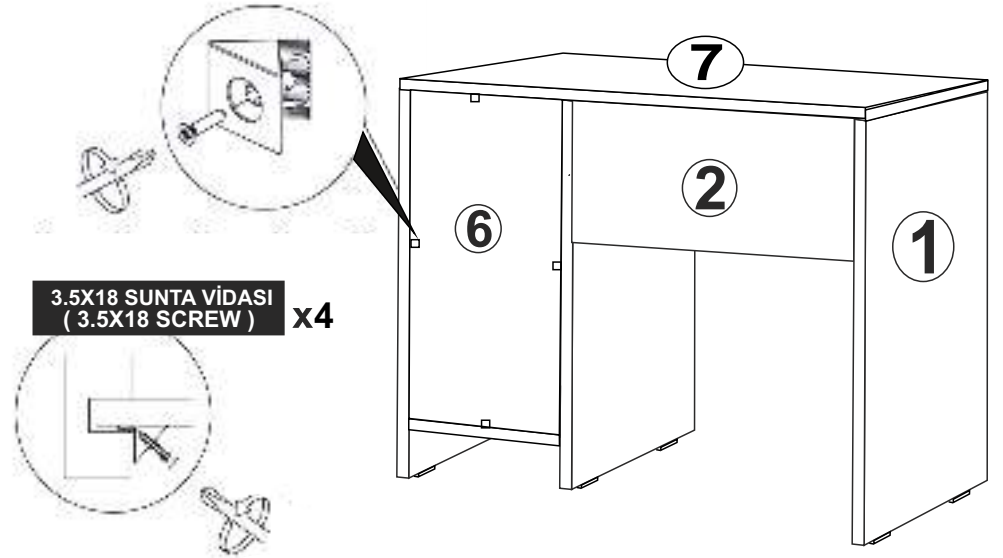
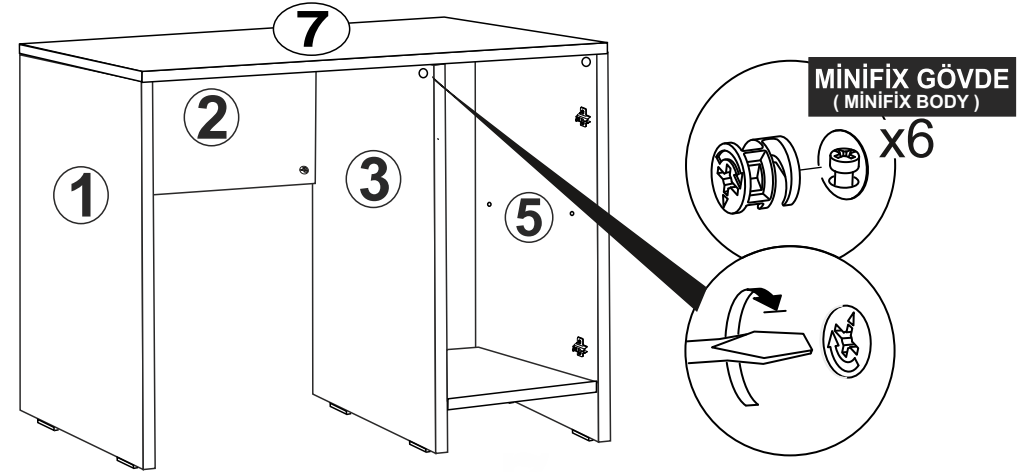

8

