

# ASSEMBLY INSTRUCTION

Ax1

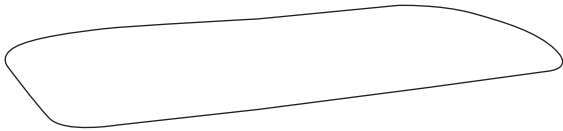

Bx1

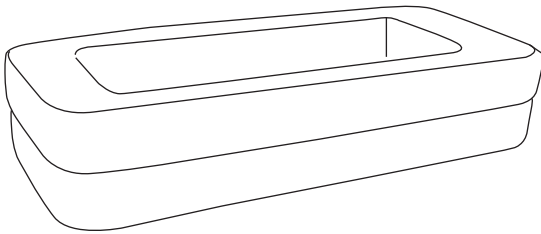

Cx4

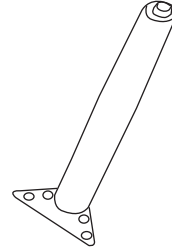

Dx16

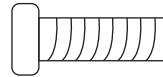

Ex1

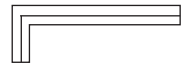

1

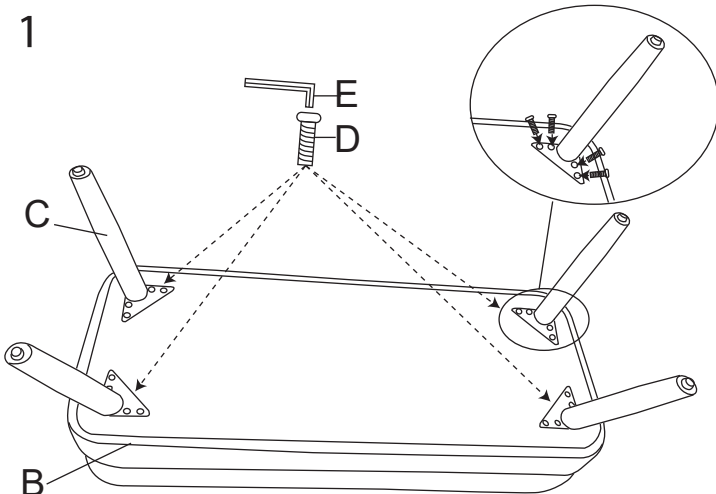

2

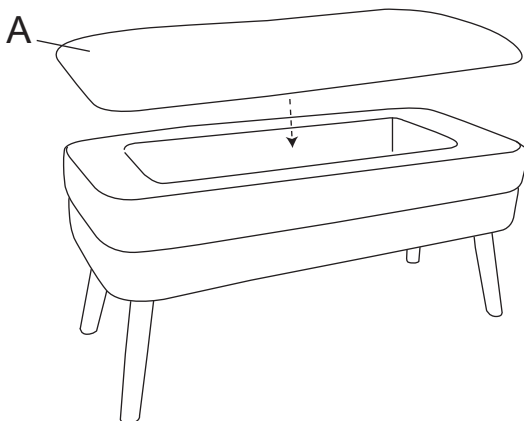

3

