









ASSEMBLY INSTRUCTIONS







6H 6/6 Panel Headboard

6F 6/6 Footboard

56R Queen/King Rail

Thank you for purchasing this quality product. Be sure to check all packing material carefully for small parts, which may have come loose inside the carton during shipment. Identify and count all parts and compare with the **HARDWARE LIST** below.

| Parts List | | | |
|------------|---|-----------------------|-------|
| No. | Drawing | Description | Qty |
| A |  | Headboard Panel | 1 pc |
| B |  | Headboard Post(Left) | 1 pc |
| C |  | Headboard Post(Right) | 1 pc |
| D |  | Bottom stretcher | 1 pc |
| E |  | Side Rails | 2 pcs |
| F |  | Footboard | 1 pc |
| G |  | Stets | 4pcs |
| H |  | Center support legs | 8pcs |

| Hardware List | | | | |
|---------------|---|------------------|-----------------|-------|
| No. | Drawing | Description | Size | Qty |
| 1 |  | Allen Bolt | Ø5/16"x1-1/2" | 8 pcs |
| 2 |  | Spring Washer | Ø5/16"x13mmx1mm | 16pcs |
| 3 |  | Flat Washer | Ø5/16"x19mmx2mm | 8pcs |
| 4 |  | Allen Key | | 1 pc |
| 5 |  | Wood Screw | #8x1" | 8 pcs |
| 6 |  | Long Bolt | Ø5/16"x3-1/4" | 8 pcs |
| 7 |  | Half Moon Washer | Ø5/16"x30x8mm | 8 pcs |
| 8 |  | Hex Nut | Ø5/16"x12mm | 8 pcs |
| 9 |  | Allen Bolt | 12mm | 1 pc |

| Tools required (not provided) | | | | |
|--------------------------------|---|--------------|--|------|
| 10 |  | Screw driver | | 1 pc |

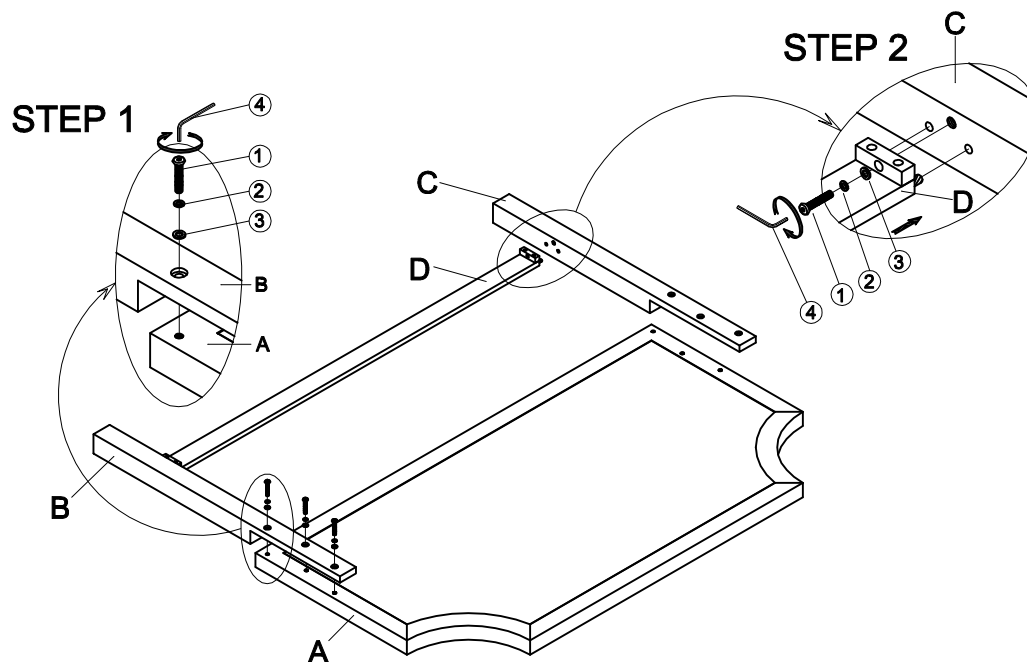

Do not fully tighten all screws and bolts until the entire item is completely assembled.