

INSTALLATION INSTRUCTIONS

LINEAR DRAINS COLLECTION

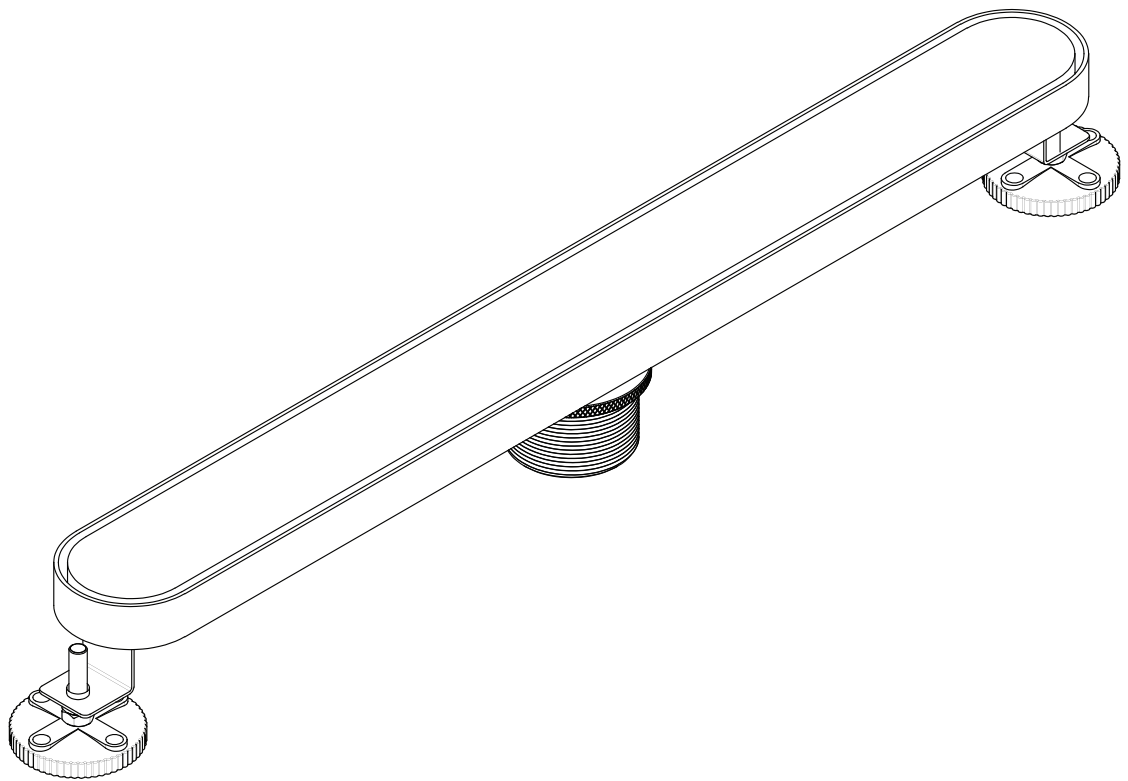



Failure to read these instructions prior to installation may result in personal injury, property damage, or product failure. Manufacturer assumes no responsibility for product failure due to improper installation.

We reserves the right to change, update, modify, alter, redesign this manual/product or its policies without prior notice!
It is your responsibility to visit the website to download or contact customer service for the most updated version of the installation instructions.
We shall not be liable for any injuries or property damages in connection with this product during installation or use of this product!

WARRANTY & LIABILITY

- The limited warranty is void for any commercial installation.
- Compliance with local building and plumbing codes is the responsibility of the installer and homeowner. Codes may vary by state and municipality.
- We do not provide compliance certifications for this product.
- Under no circumstances shall the manufacturer, distributor, or retailer be liable for any incidental, consequential, or water-related damages arising from the use or installation of this product.
- We are not responsible for any costs related to installation, reinstallation, removal, transportation, labor, or subsequent damage in the event of a product defect.

IMPORTANT SAFETY INSTRUCTIONS

- Comply with all applicable local building and plumbing codes.
- Professional installation by a licensed plumber and contractor is strongly recommended.
- Follow the enclosed installation instructions. Alternative methods may be appropriate depending on site conditions.
- Prior to installation, properly frame the shower alcove, install the curb, and secure 2x10 blocking in the stud bays around the perimeter of the shower base.
- If you are uncertain about any installation step, consult a qualified professional.

PLUMBING

- Confirm the model fits the intended location and that the drain outlet is properly positioned before installation.
- The minimum shower trap size for new installations is 2 inches.
- Maintain a minimum slope of 1/4 inch per foot for proper drainage.
- Allow the product to acclimate to room temperature for at least 30 minutes prior to installation.

COMPONENTS AND HARDWARE

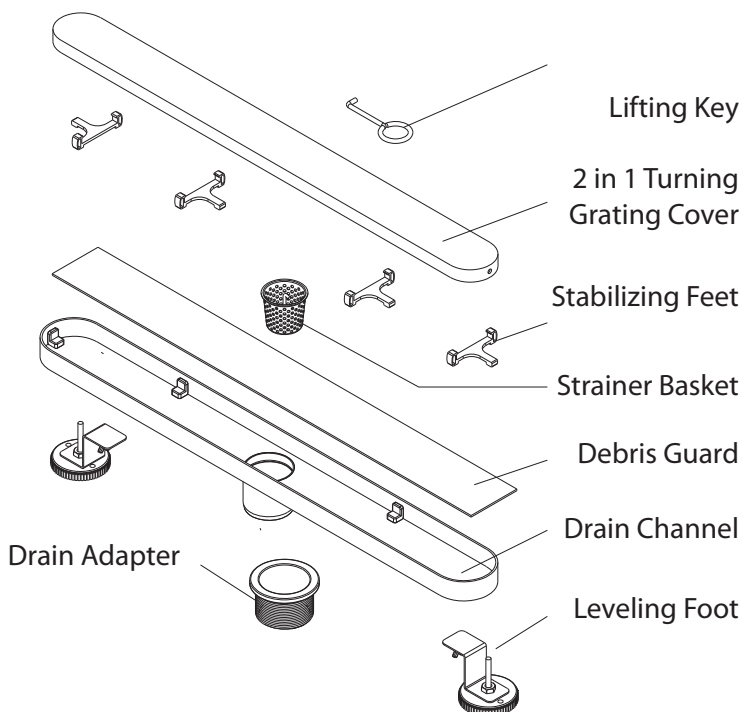

**SUBDRAIN IS NOT INCLUDED
IN SHOWER DRAIN SET.**

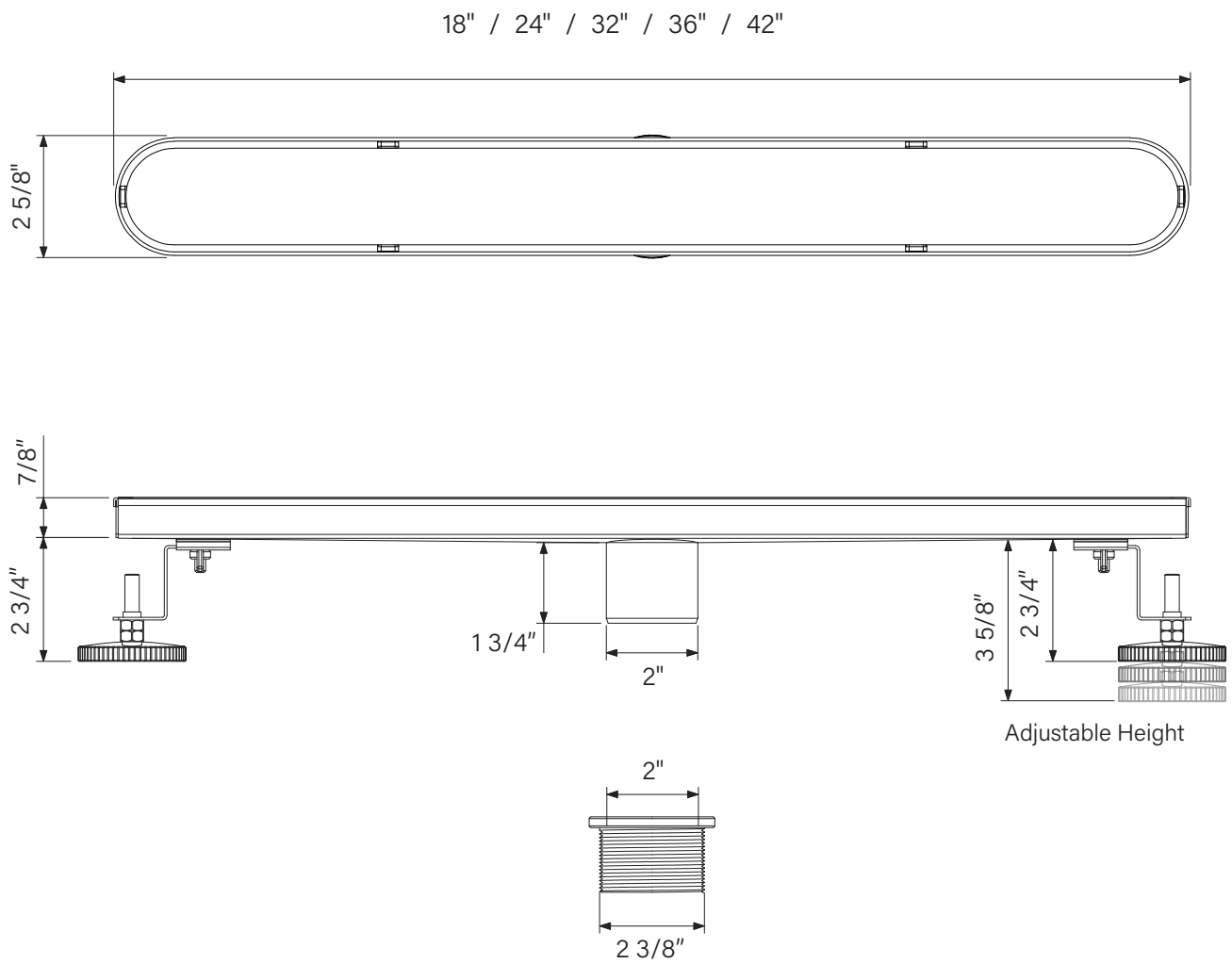

1

INSTALL THE DRAIN ADAPTER

1. Screw drain adapter into the subdrain (not included).
Note: Subdrain is not included in shower drain set.
Subdrain needs to be installed prior to installation of Linear drain set.

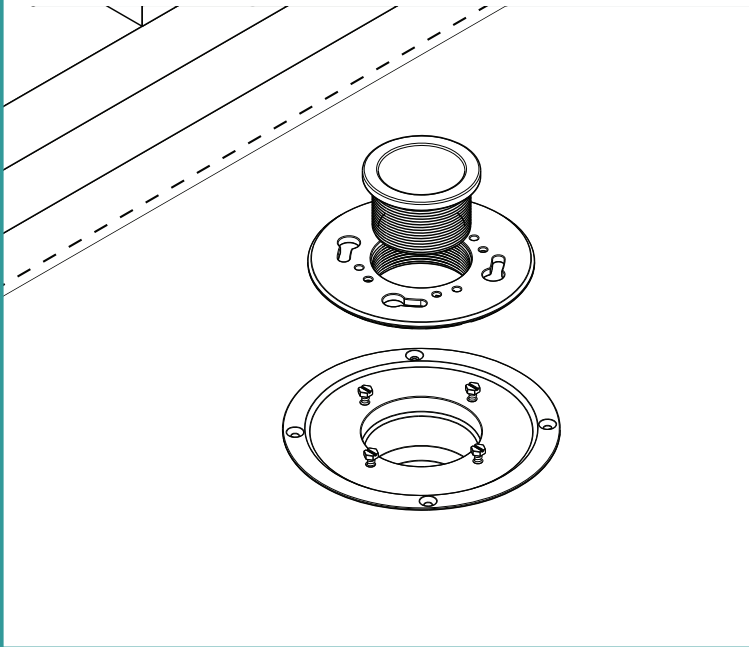

2

INSTALL DRAIN BODY

1. Insert the drain body into the hole of the drain flange and position properly.

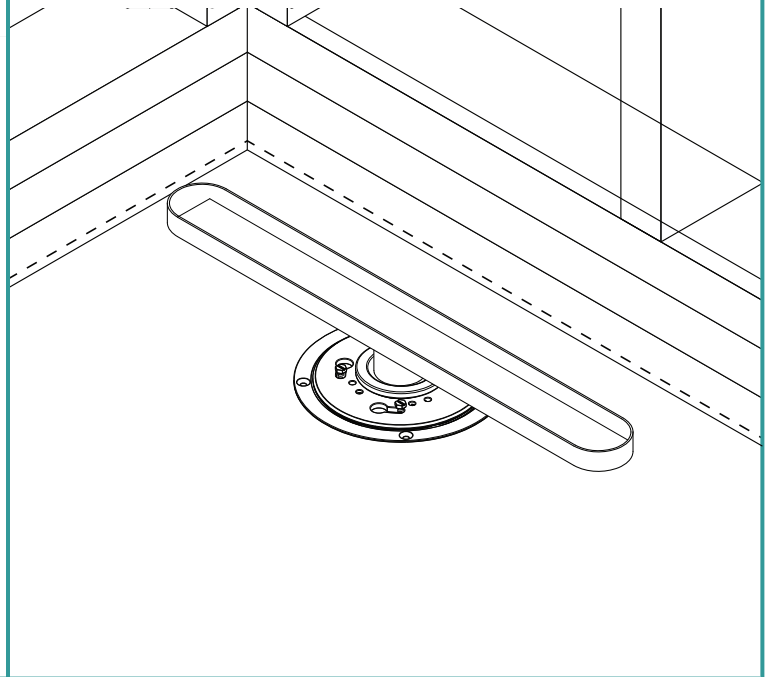

3

LEVEL DRAIN CHANNEL

1. Level drain channel with a level.
2. Adjust the leveling foot on both ends to make sure the drain is level.

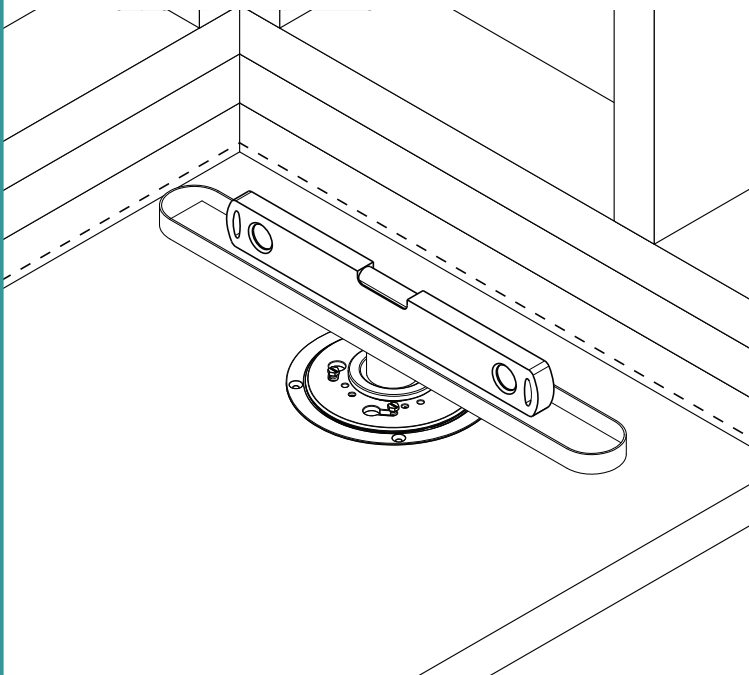

4

INSTALL STRAINER BASKET AND GRATE COVER

1. Insert strainer basket into hole of drain channel.
2. Insert grate cover into drain channel.

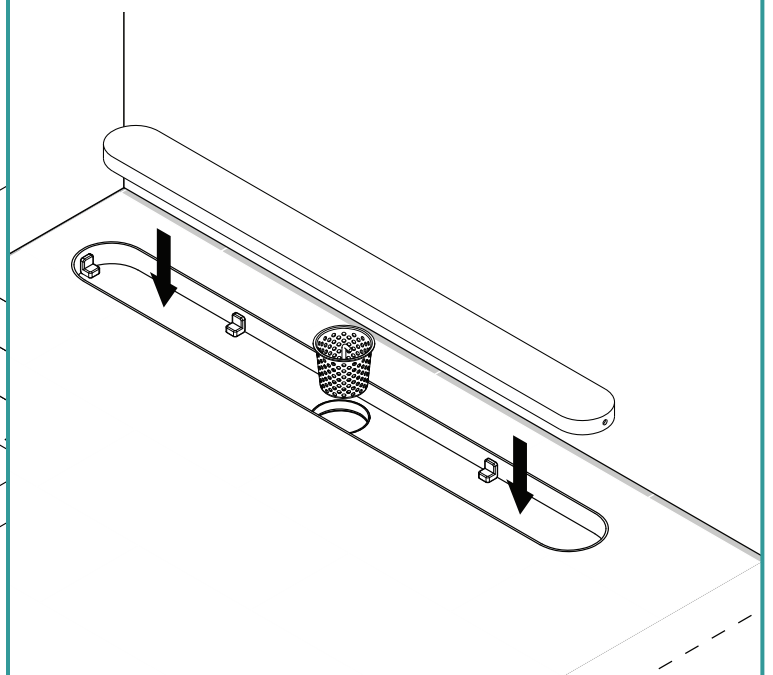

1

INSTALL TILE INTO THE GRATE COVER

Cut your tile, stone, or other finishing material to fit precisely within the recessed area of the face cover. Using a strong, waterproof adhesive, securely set the tile into the frame. Use a level to ensure the tile surface is flush with the top edges of the frame. Allow the adhesive to fully cure according to the manufacturer's instructions before proceeding.

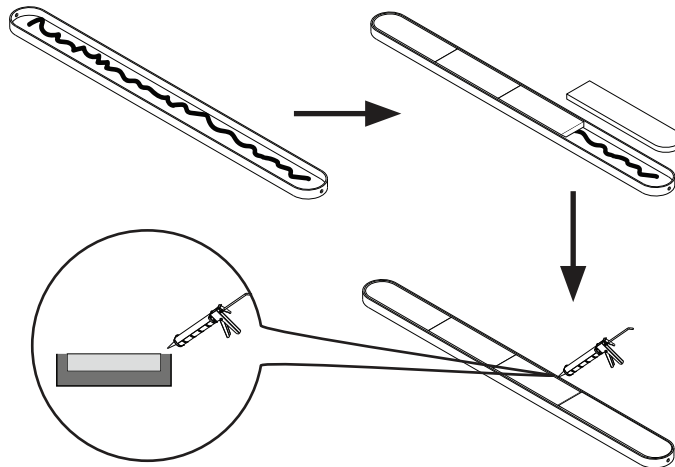

2

INSTALL STRAINER BASKET AND GRATE COVER

1. Insert the strainer basket into the drain channel.
2. Insert the grate cover into the drain channel.

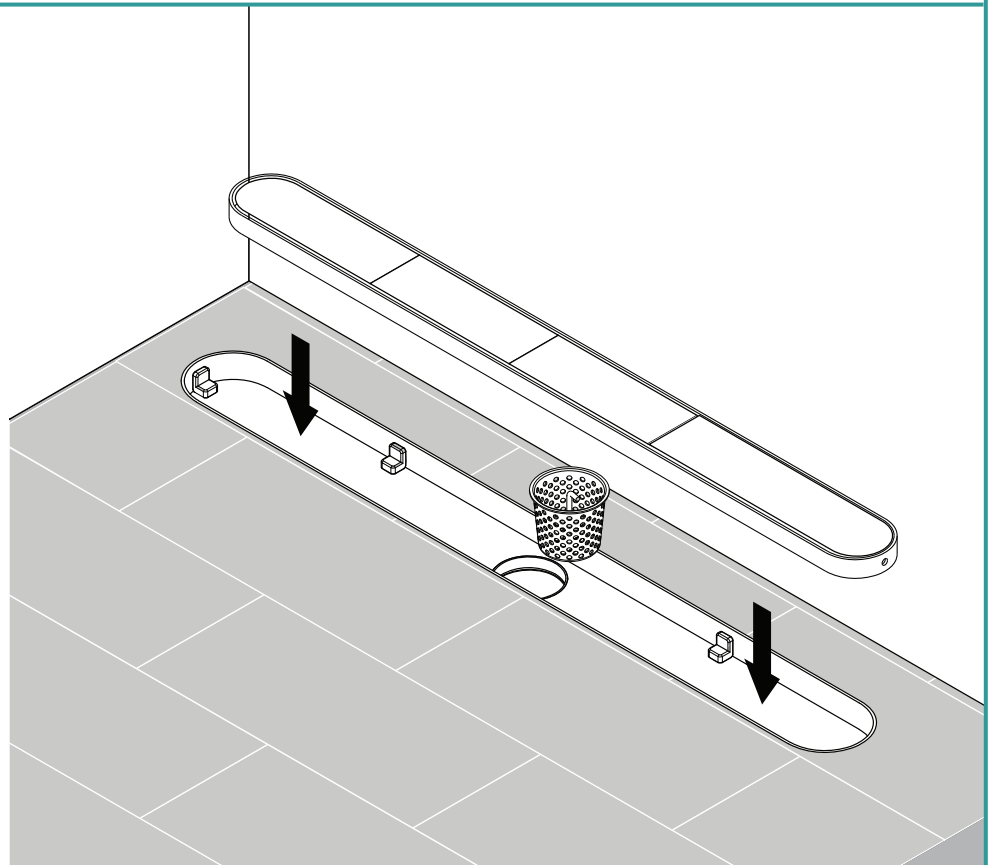



206 WEMBLY ROAD - NEW WINDSOR, NY 12553
P: 718.602.6060 F: 718.963.2082 - E: INFO@FINEFIXTURES.COM
TOLL FREE: 1.877.8FIXTURES

FINEFIXTURES.COM

