

ASSEMBLY INSTRUCTIONS

BED - FULL

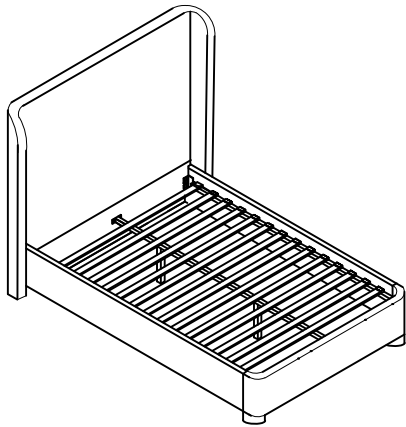

+ Parts Included

① Head Board
(1pc)

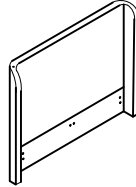

② Foot Board
(1pc)

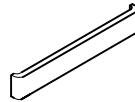

③ Side Rails
(2pcs)

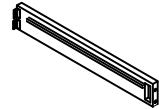

④ Center Support Bar
(1pc)



⑤ Support Legs
(2pcs)

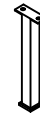

⑥ -Legs(2pcs)



⑦ Slats joint
(1set=13pcs)

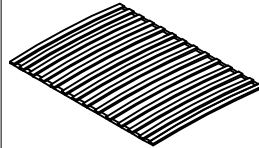

*Slats come packed in the bottom of headboard carton.

+ Do Not Use Power Tools



+ Suggested Adults

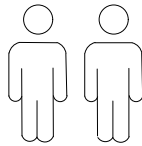

NOTE:

- 1 Read instructions cover to cover.
- 2 Save all packaging until assembly is completed.

1 IMPORTANT SAFETY INFORMATION

Do not assemble the product if any of the following parts arrived damaged:

- Part #③ -Side Rails
- Part #④ -Center Support Bar
- Part #⑤ -Support Legs
- Part #⑦ -Slats joint

2 IMPORTANT ASSEMBLY INFORMATION

Assembly Step ② Ensure the side rail bracket is fully hooked onto bolt A loosely threaded with both washers on the OUTSIDE of the bracket first, then proceed to fully tightening all 4 corners.

*Slats come packed in the bottom of headboard carton.

+ Hardware Included

A Bolt M8*40mm
(12pcs)



B Bolt M8*115mm
(4pcs)



C Spring Washer
(4pcs)



D Bolt M8*70mm
(4pcs)



E Flat Washer
Φ20(20pcs)



F M8 Allen Key
(1pc)



G Spanner
(1pc)



H Nut M8*13mm
(8pcs)



ASSEMBLY INSTRUCTIONS

BED - FULL

