

12'x14'

SKU:LGMF1554

HARDTOP GAZEBO WITH DOUBLE ROOF

Assembly Manual

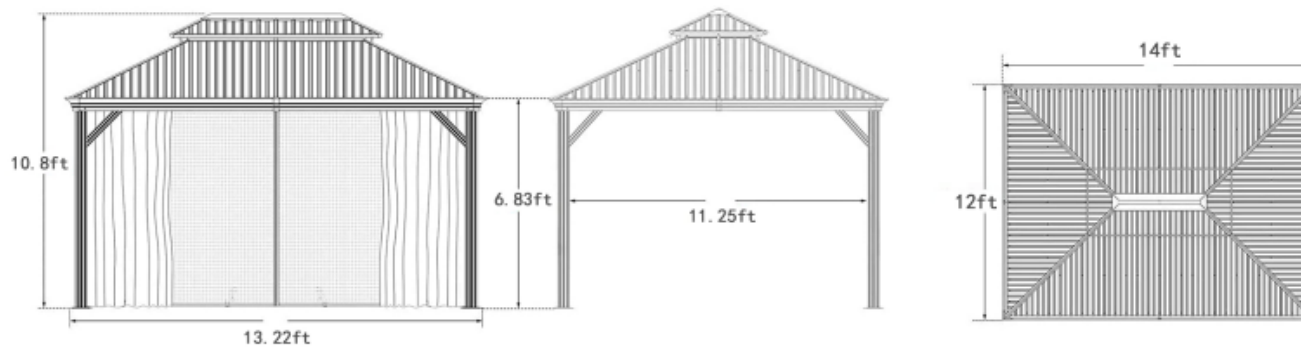

Pre-assembly

TOOLS THAT MAY BE REQUIRED (Not included in boxes)

*NOTE: Tools / equipment are not shown to actual size and scale.



LEVEL



RUBBER Mallet



PHILLIPS SCREW



DRILL

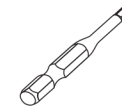

ALLEN KEY

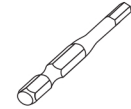

ALLEN KEY

EQUIPMENT REQUIRED (Not included in boxes)

*NOTE: Equipment are not shown to actual size and scale.



SAFETY HAT



GLOVES



SAFETY GOGGLES



STEPLADDER

Matters needing attention



1. Two or more people are required for assembly.



2. Do not fully tighten screws prior to complete assembly.

MOUNTING BLUEPRINT

Gazebo 12×14

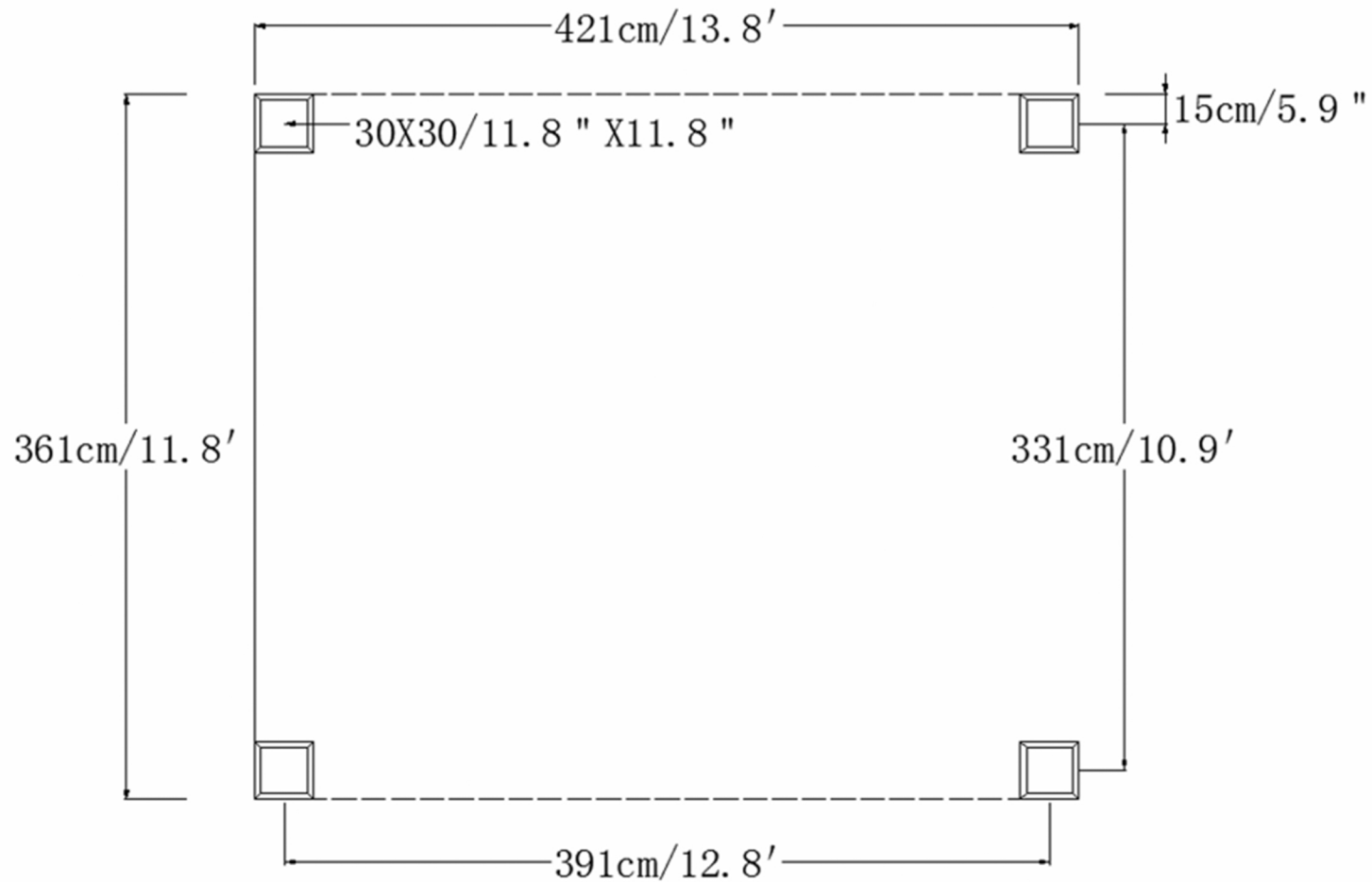

1

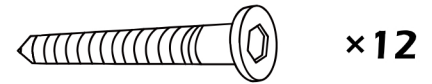
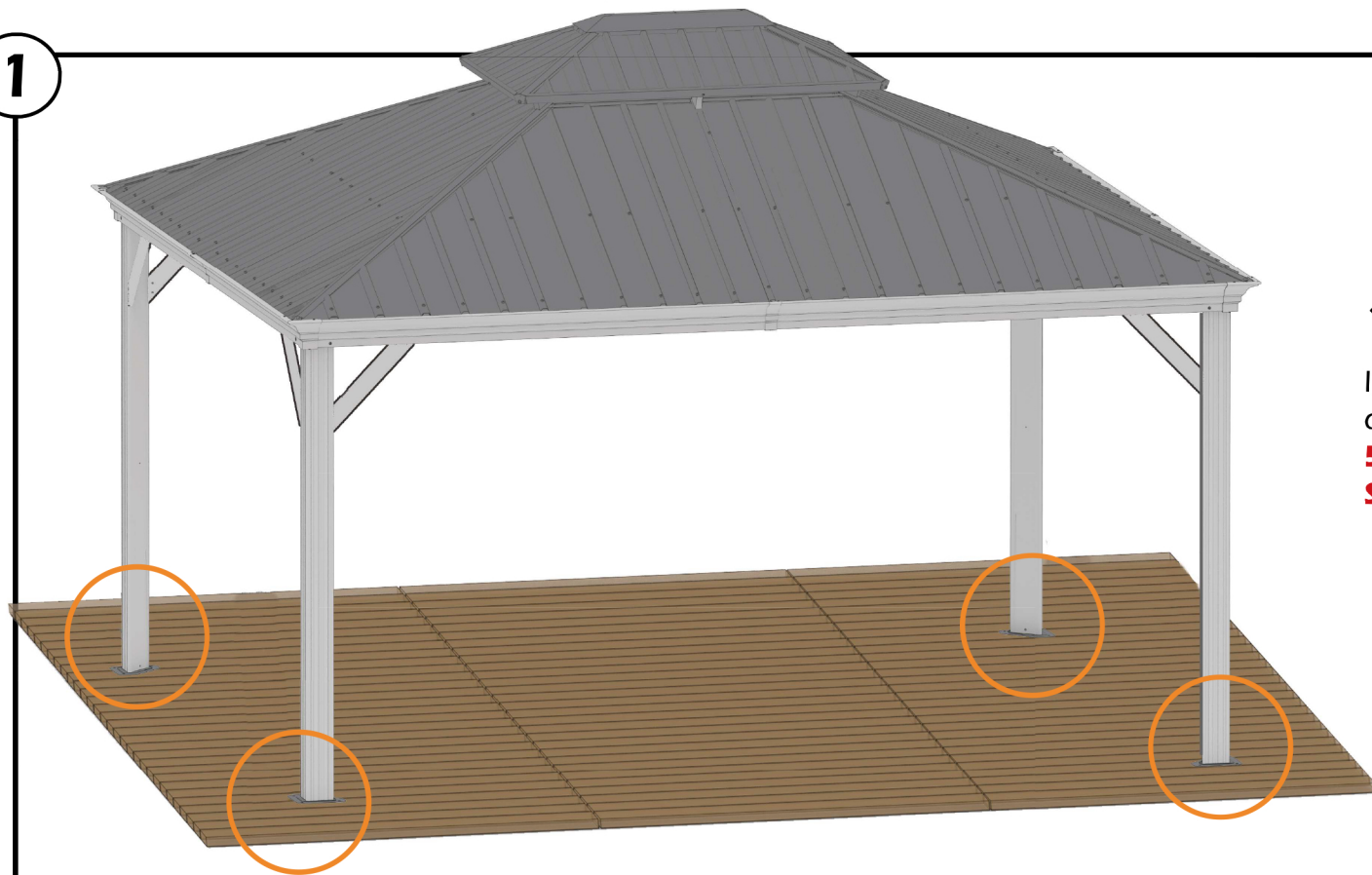

If the deck is hard wood and the depth of it is over 3 inch, you can use **5/16 in. x4 in. Structural Wood Screw** to mount the gazebo.

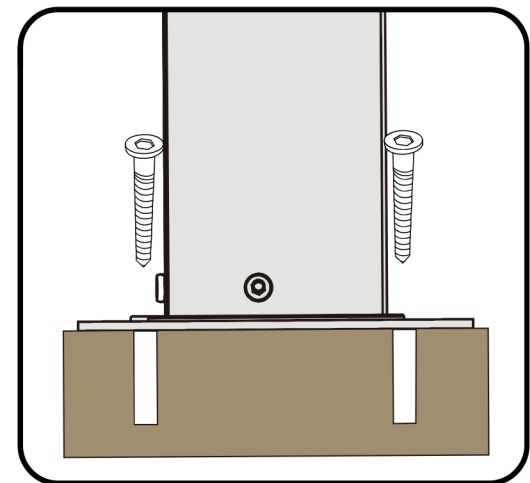
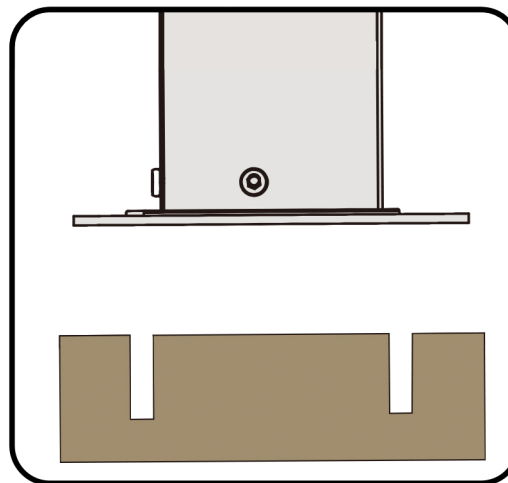

2

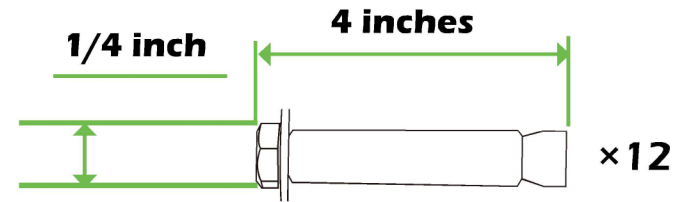
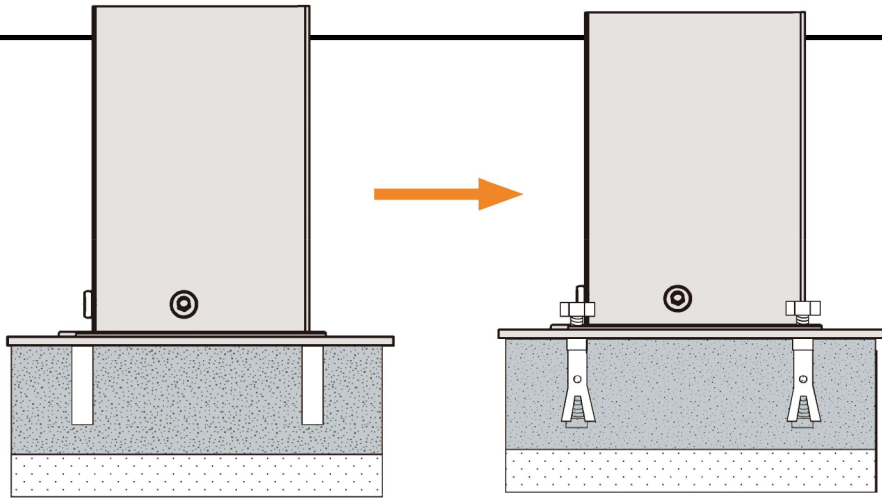

If the ground is concreted and the depth of it is over 3 inch, you can use 1/4 inch expansion bolts to mount the gazebo

3



Or you can make a concrete footing for gazebo, **11.8x11.8x11.8 inches** is recommended. Use expansion bolts to mount the gazebo like ② shows.

IMPORTANT:
Anchor is not recommended

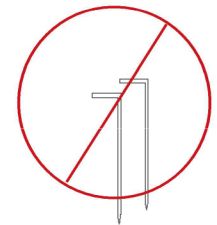

CHECK LIST



A × 4

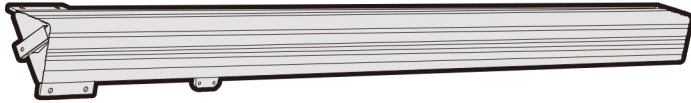

B × 2

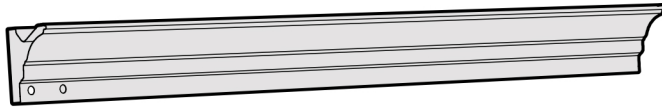

B1 × 2

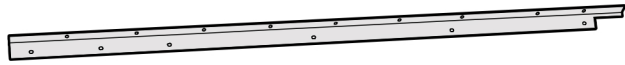

B2 × 2



C × 2

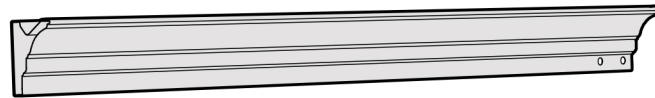

C1 × 2



C2 × 2



D × 2

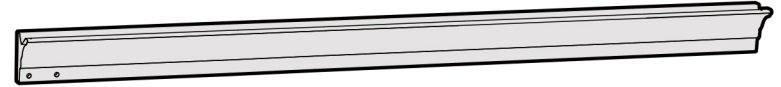

D1 × 2



D2 × 2



E × 2

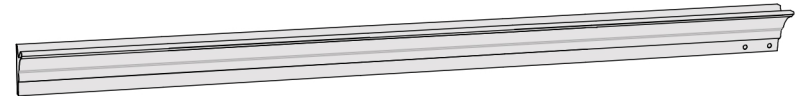

E1 × 2

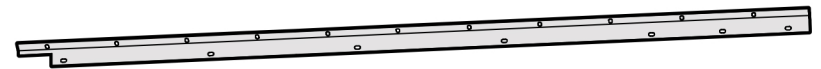

E2 × 2



F × 4

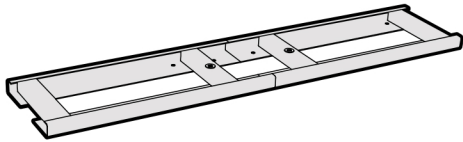

G × 4

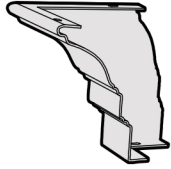

H × 4

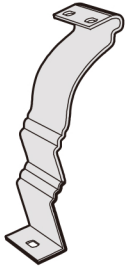

H1 × 4

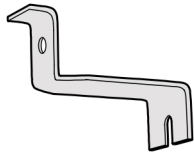

H2 × 1

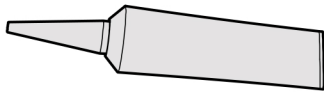

J1 × 4



J2 × 4



K × 1

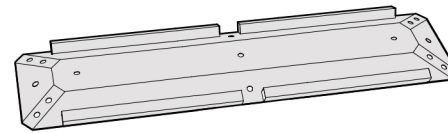

K1 × 1

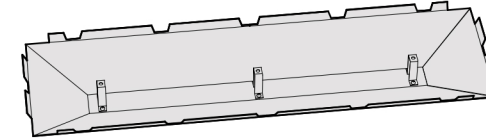

L × 4

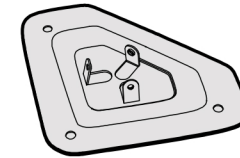

M × 4



N × 4



P × 2

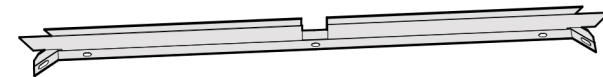

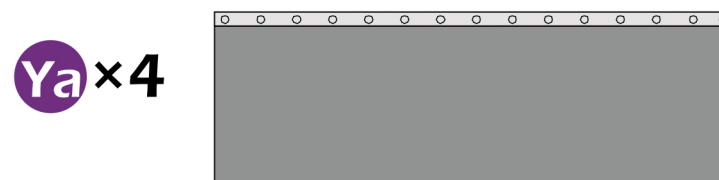
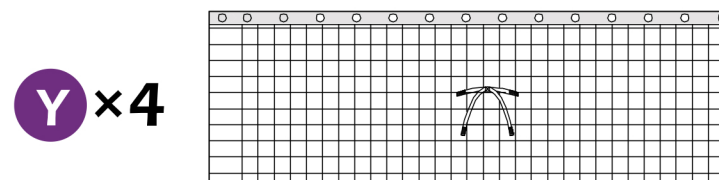
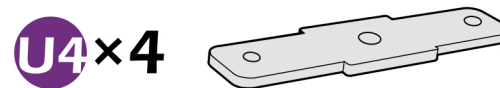
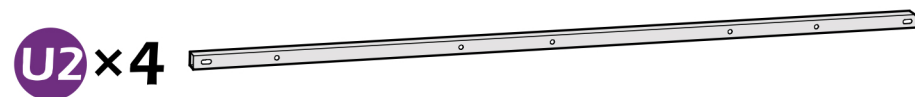
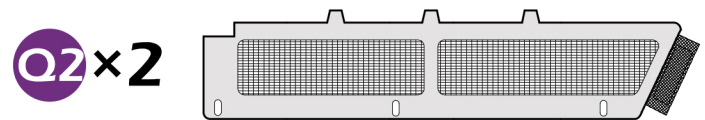
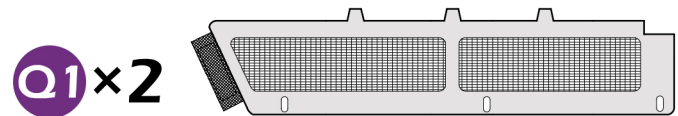
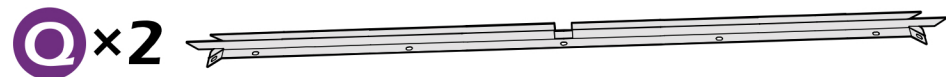
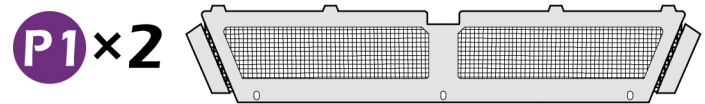

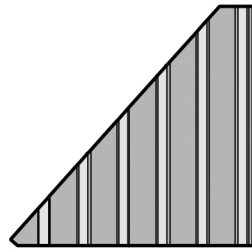

V1x2

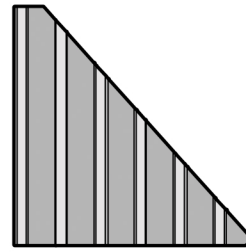

V2x2

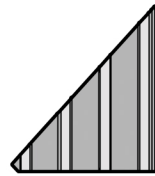

V3x2

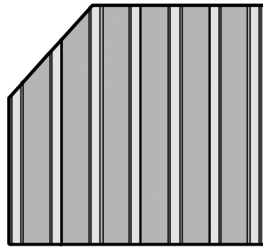

V4x2

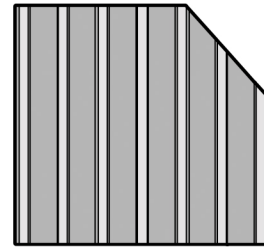

V5x2

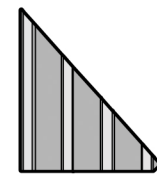

V6x2



W1x2

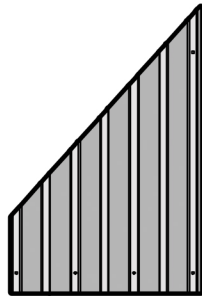

W2x2

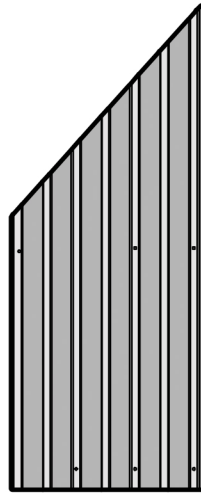

W3x2

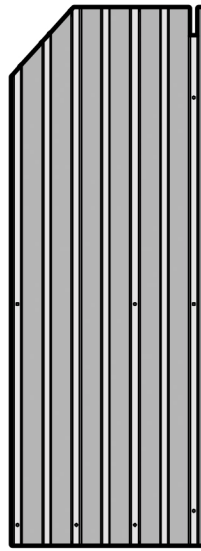

W4x2

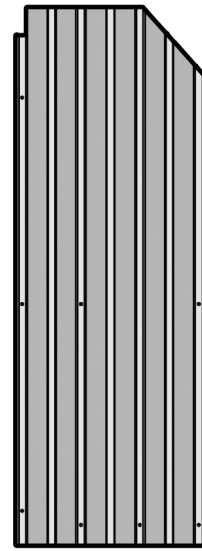

W5x2

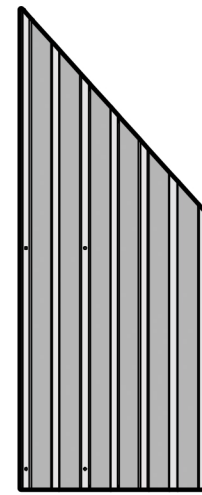

W6x2

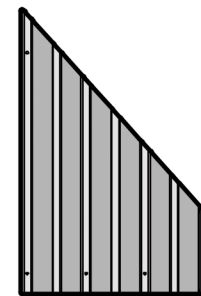

W7x2



W8x2

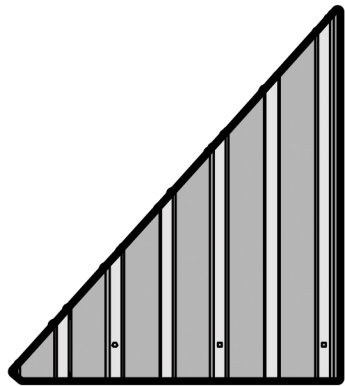

X1×2

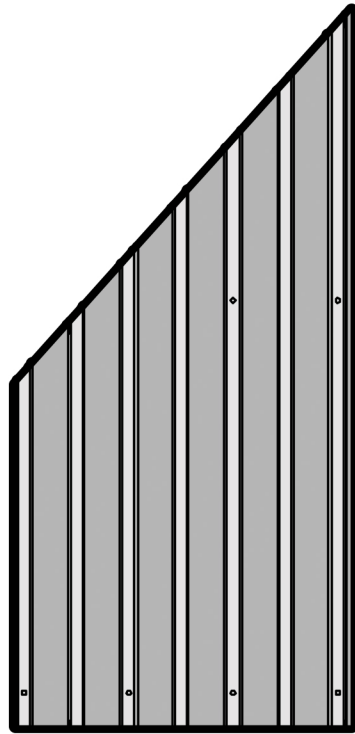

X2×2

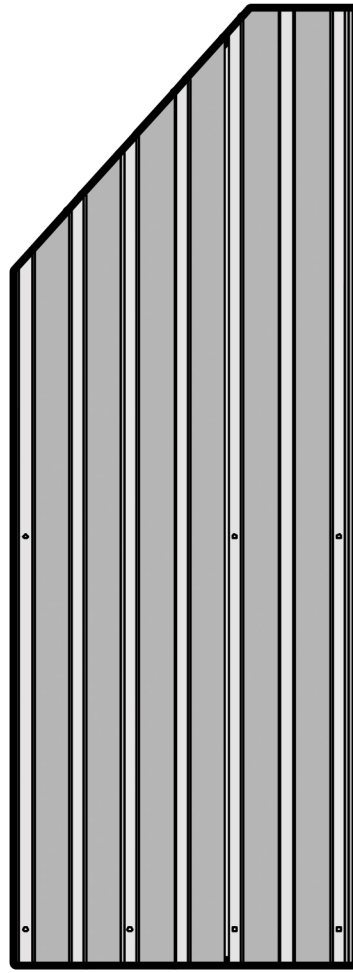

X3×2

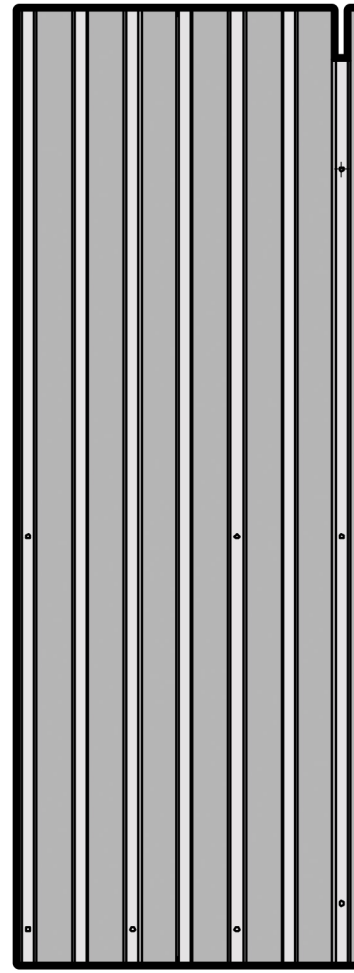

X4×2

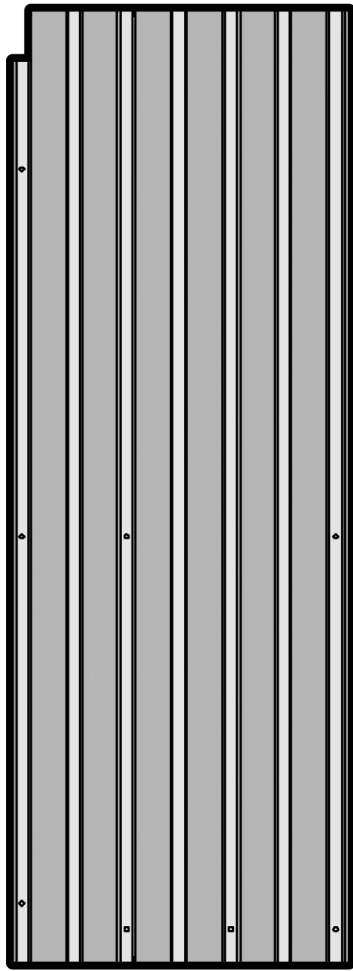

X5×2

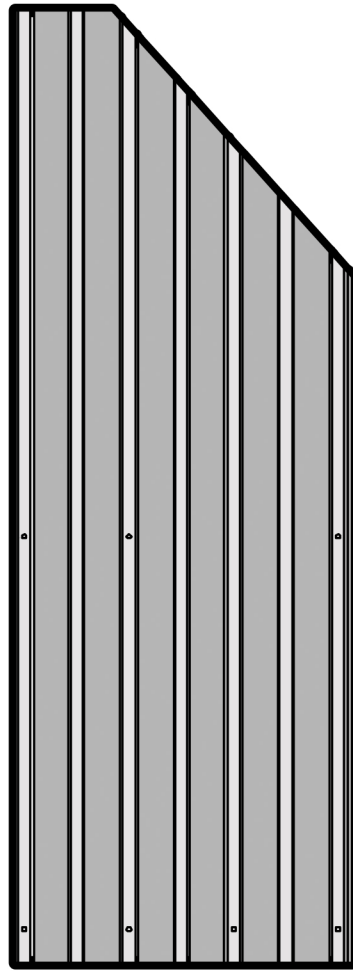

X6×2

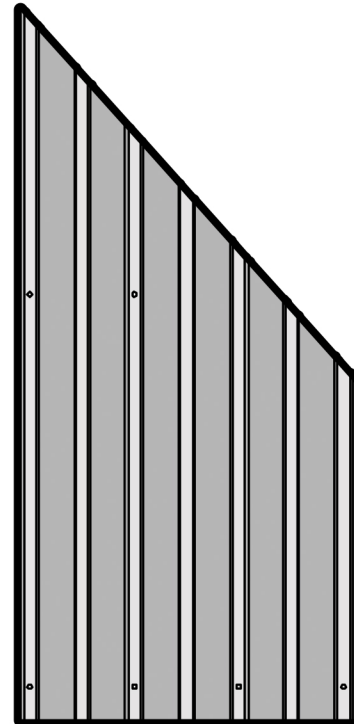

X7×2

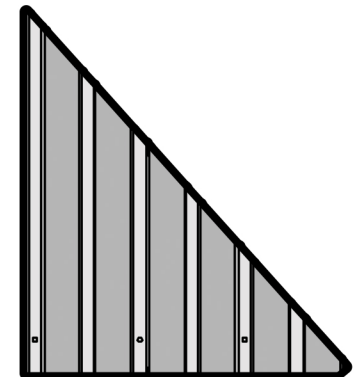

X8×2

Z×72



Z1×6



Z2×6



Z3×2



Z4×2



1#×225

(M6×16)

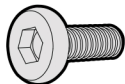

2#×16

(M6×20)

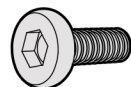

3#×16

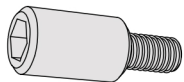

4#×120

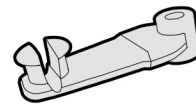

5#×80

(M6×28)

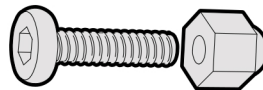

6#×8

(M6×45)

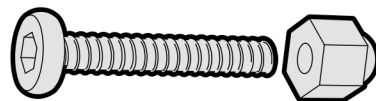

7#×36

(M6×50)

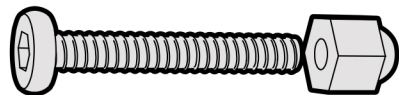

8#×4

(M5×16)

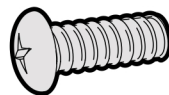

9#×24

(ST4.8×13)

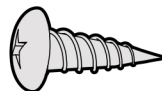

10#×4

(M6×25)

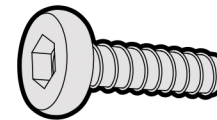

11#×12

(M6×10)

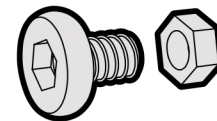

12#×1



13#×1



14#×1

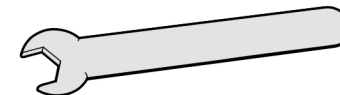

15#×1





STEP 1



A × 4



L × 4

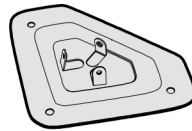

1# × 12

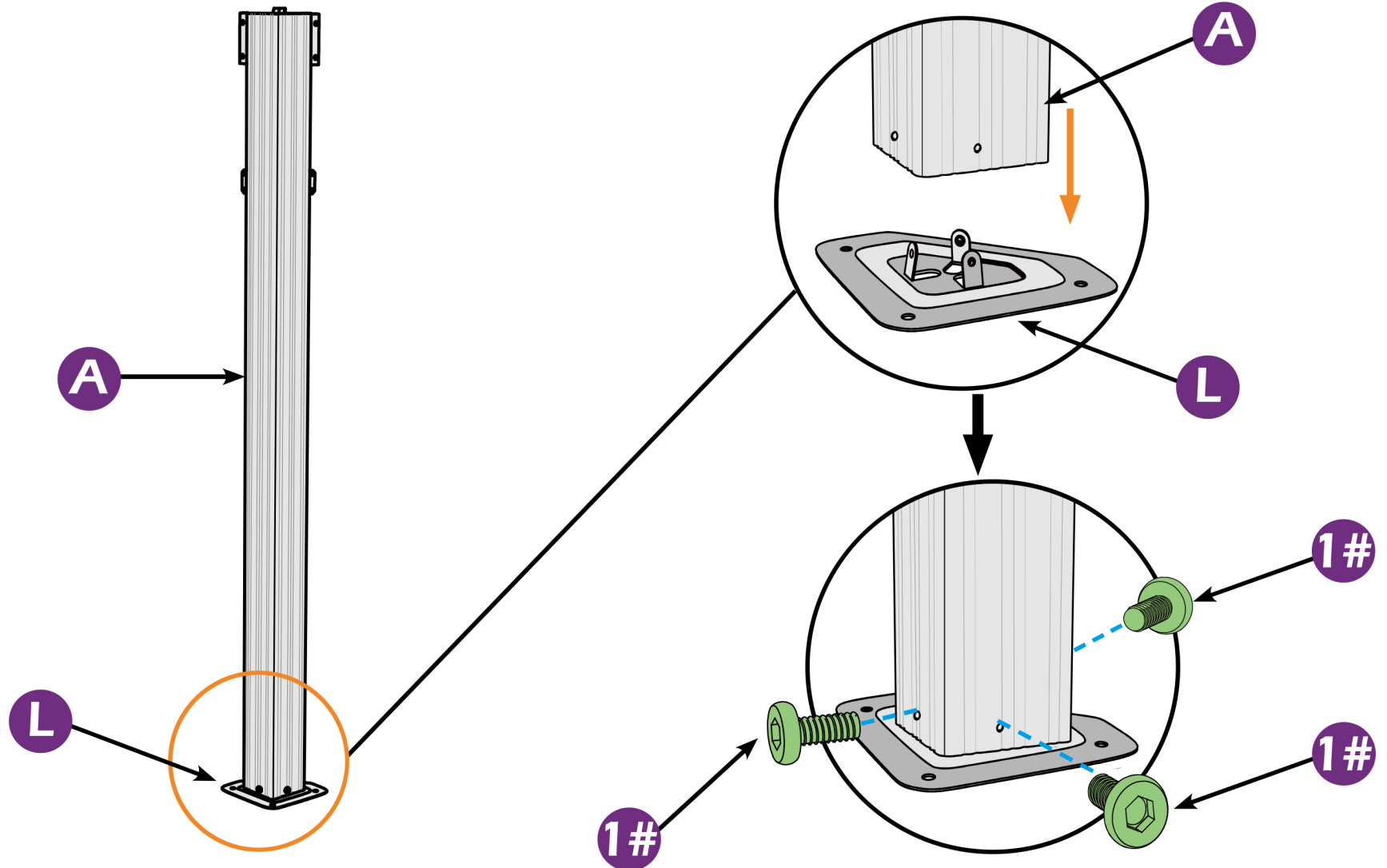
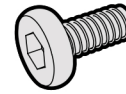

STEP 1



B × 2

F × 2

C × 2

1# × 8

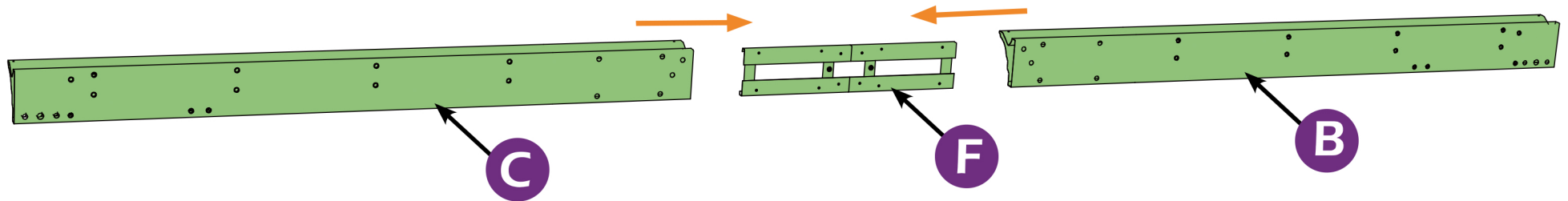

STEP 1

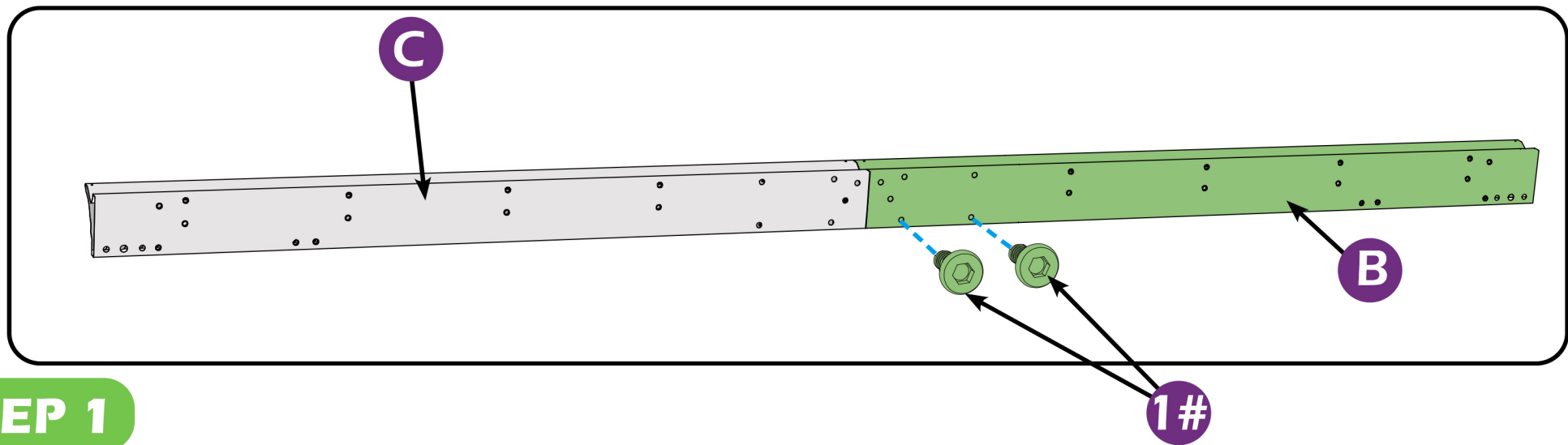
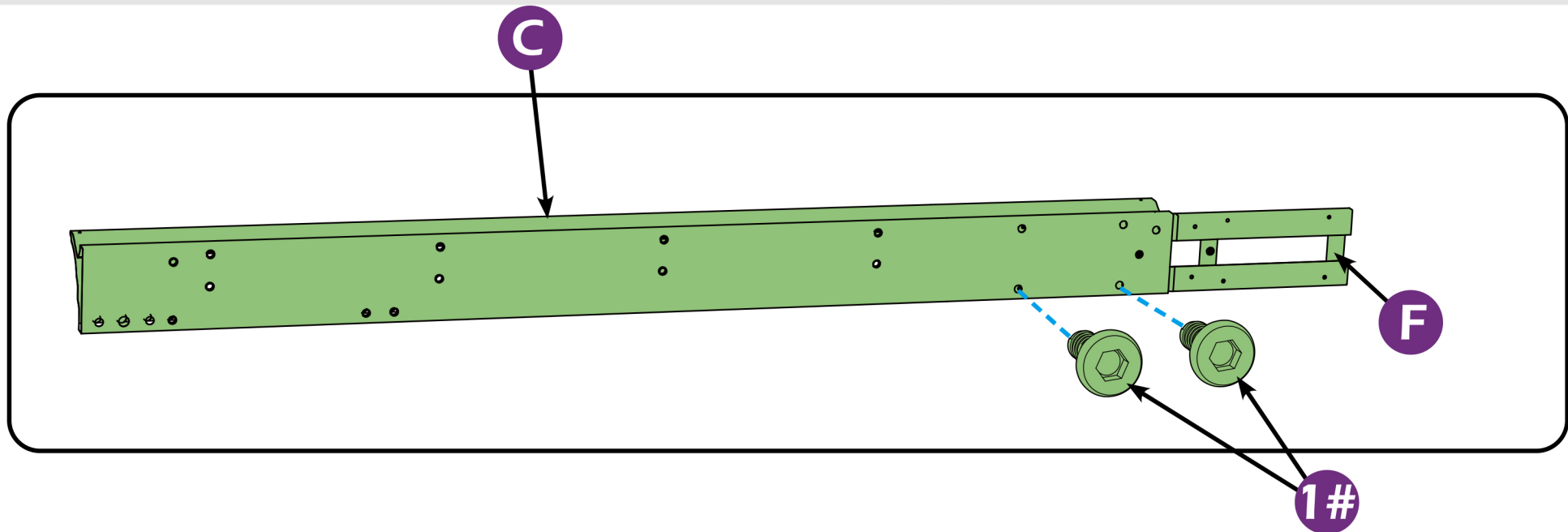

STEP 1

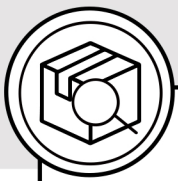

C1 × 2



1# × 24

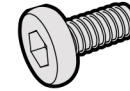

B1 × 2

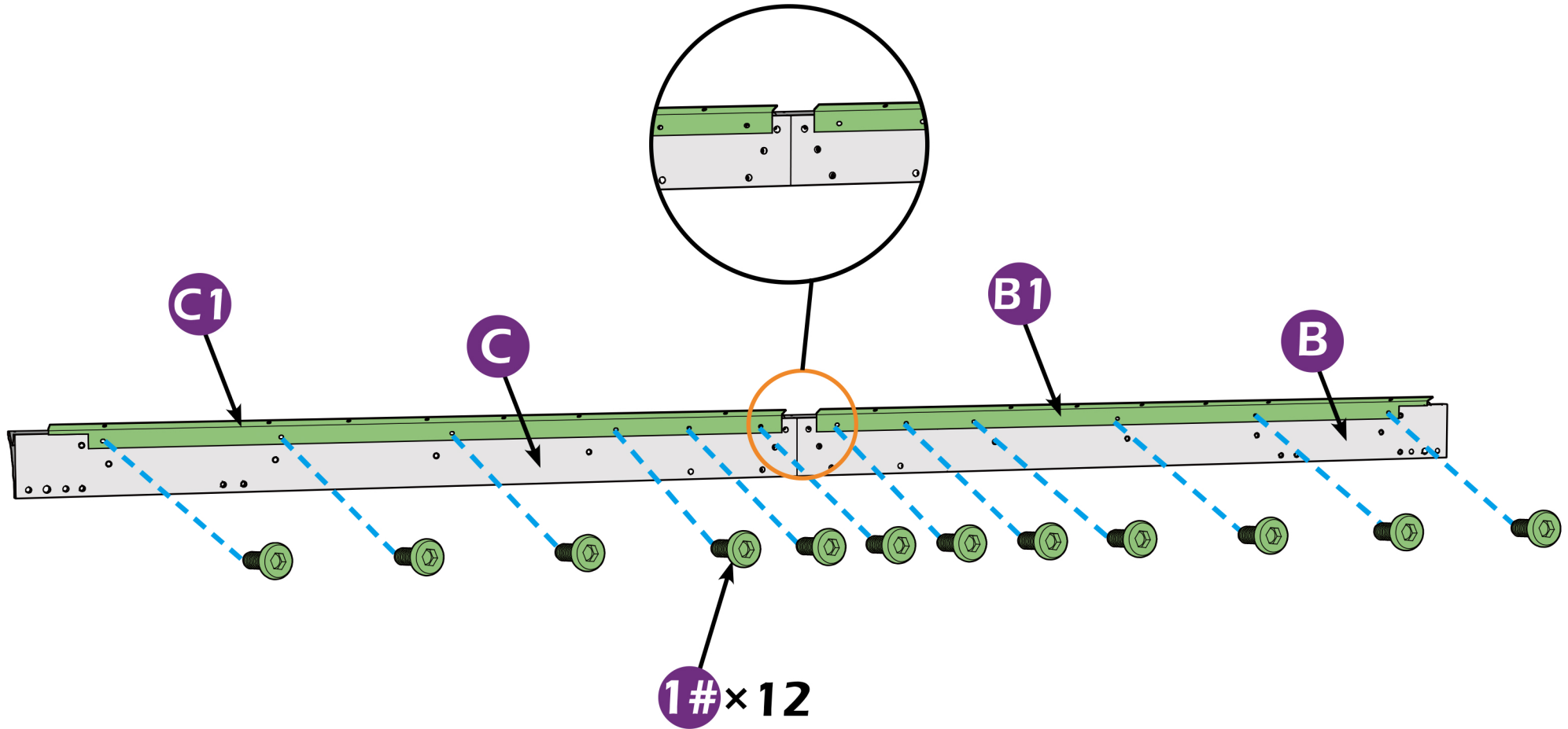
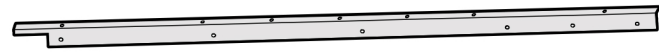

STEP 1



D × 2

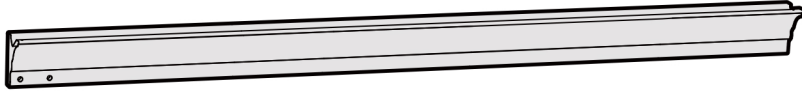

F × 2

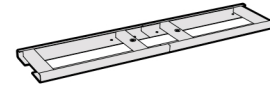

E × 2

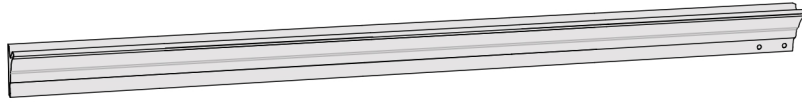

1# × 8

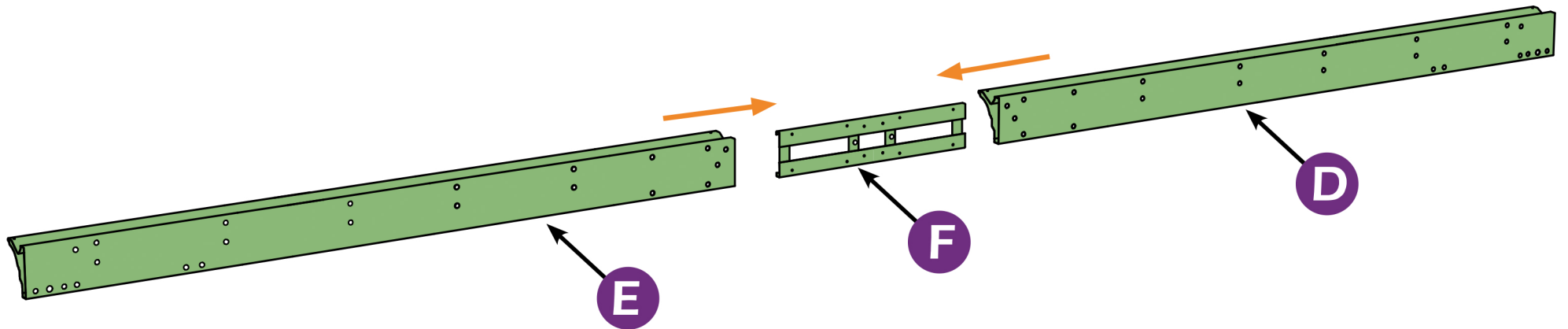
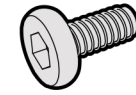

STEP 1

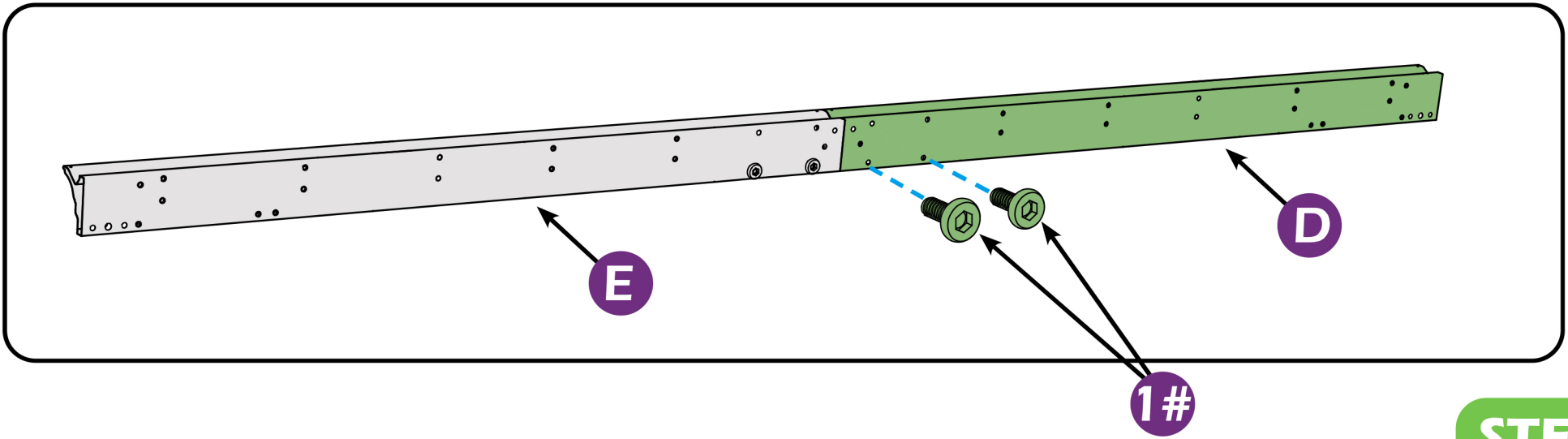
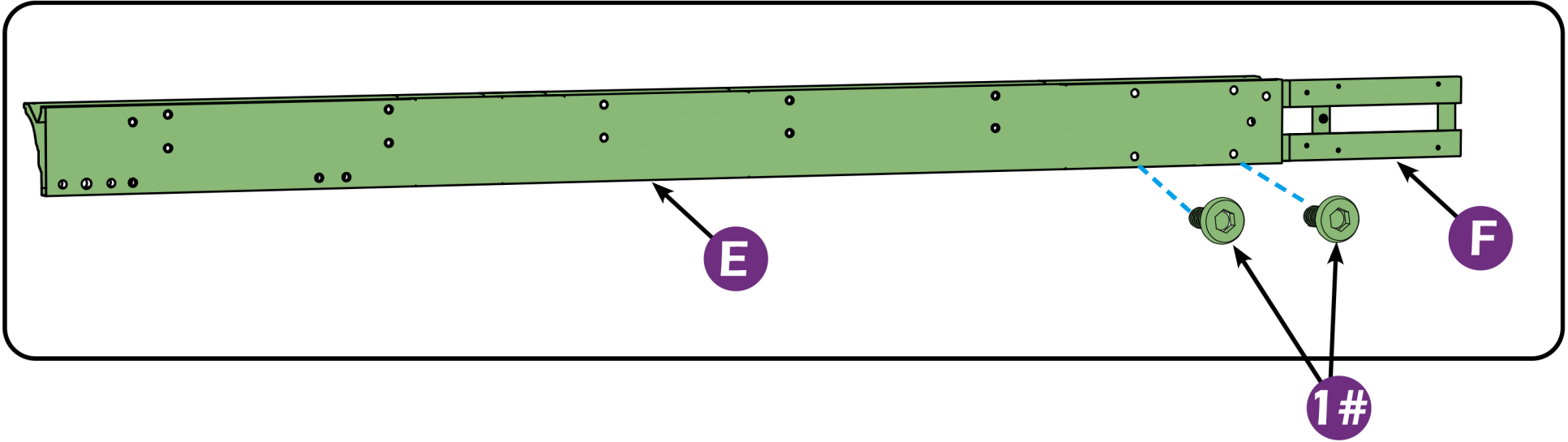

STEP 1

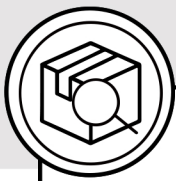

D1 × 2

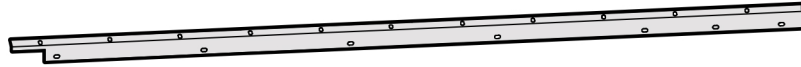

1# × 28

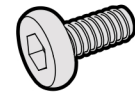

E1 × 2

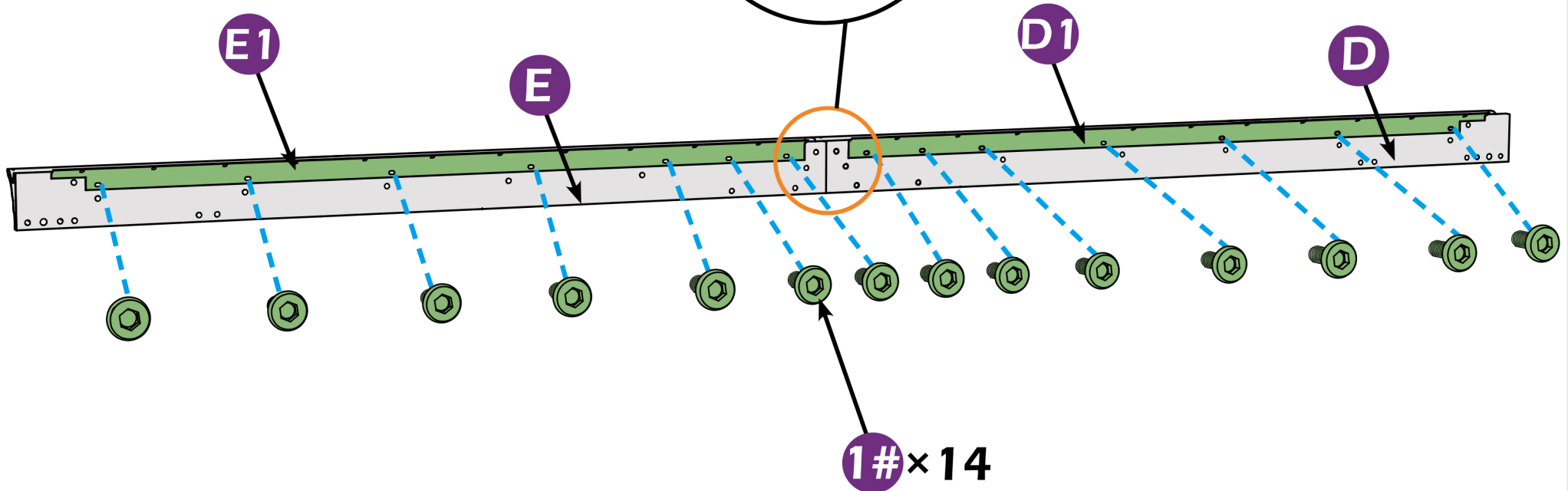
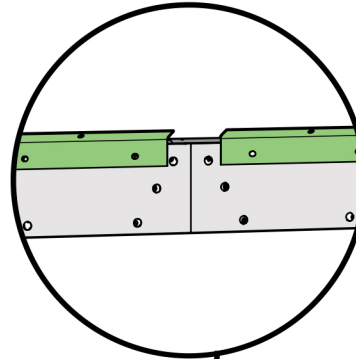

STEP 1

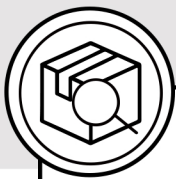

2# × 16

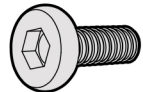

3# × 16

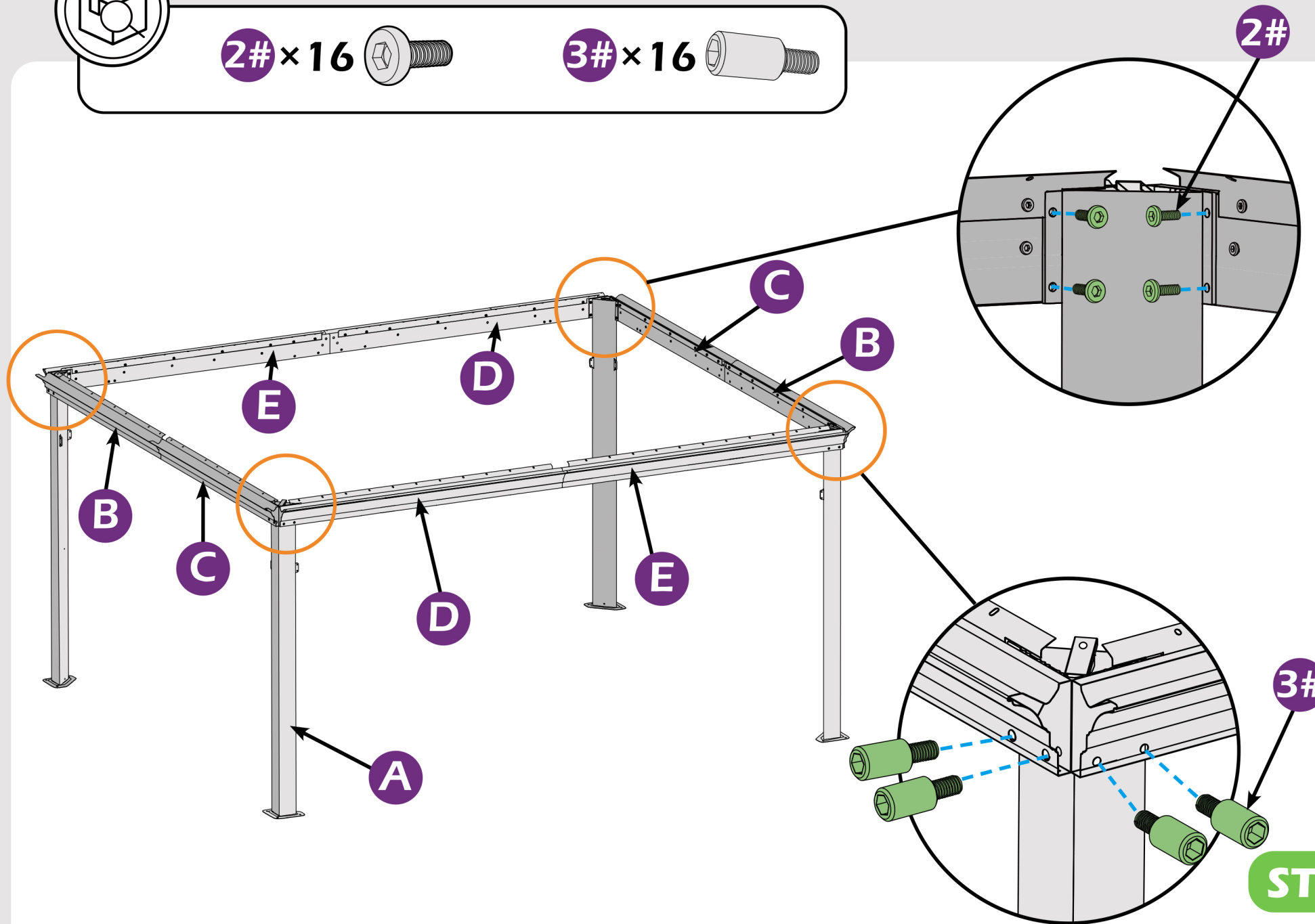
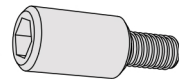

STEP 1

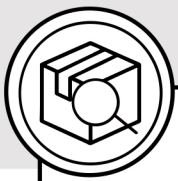

J1 × 4



1# × 32

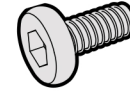

J2 × 4

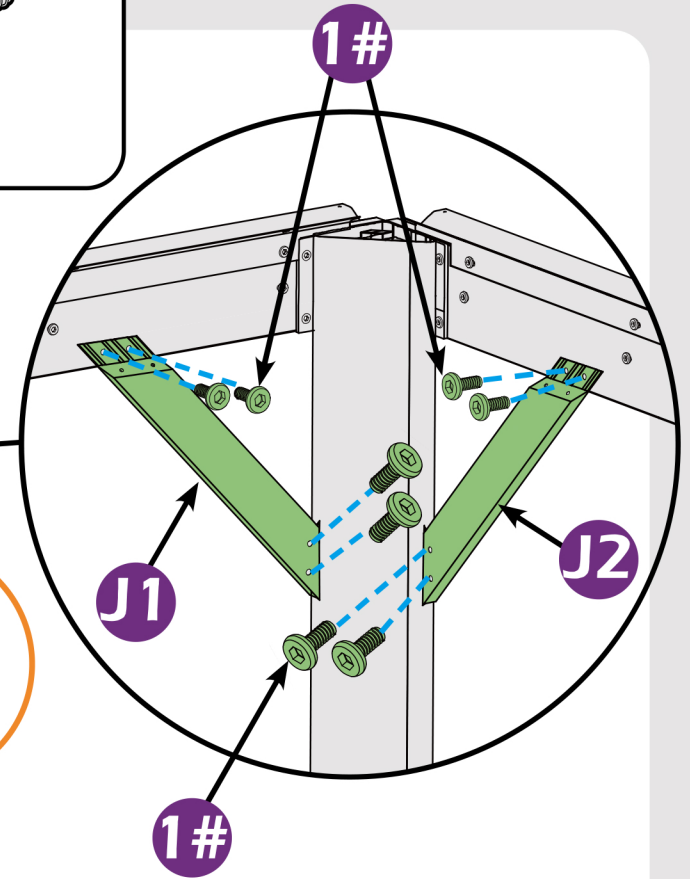
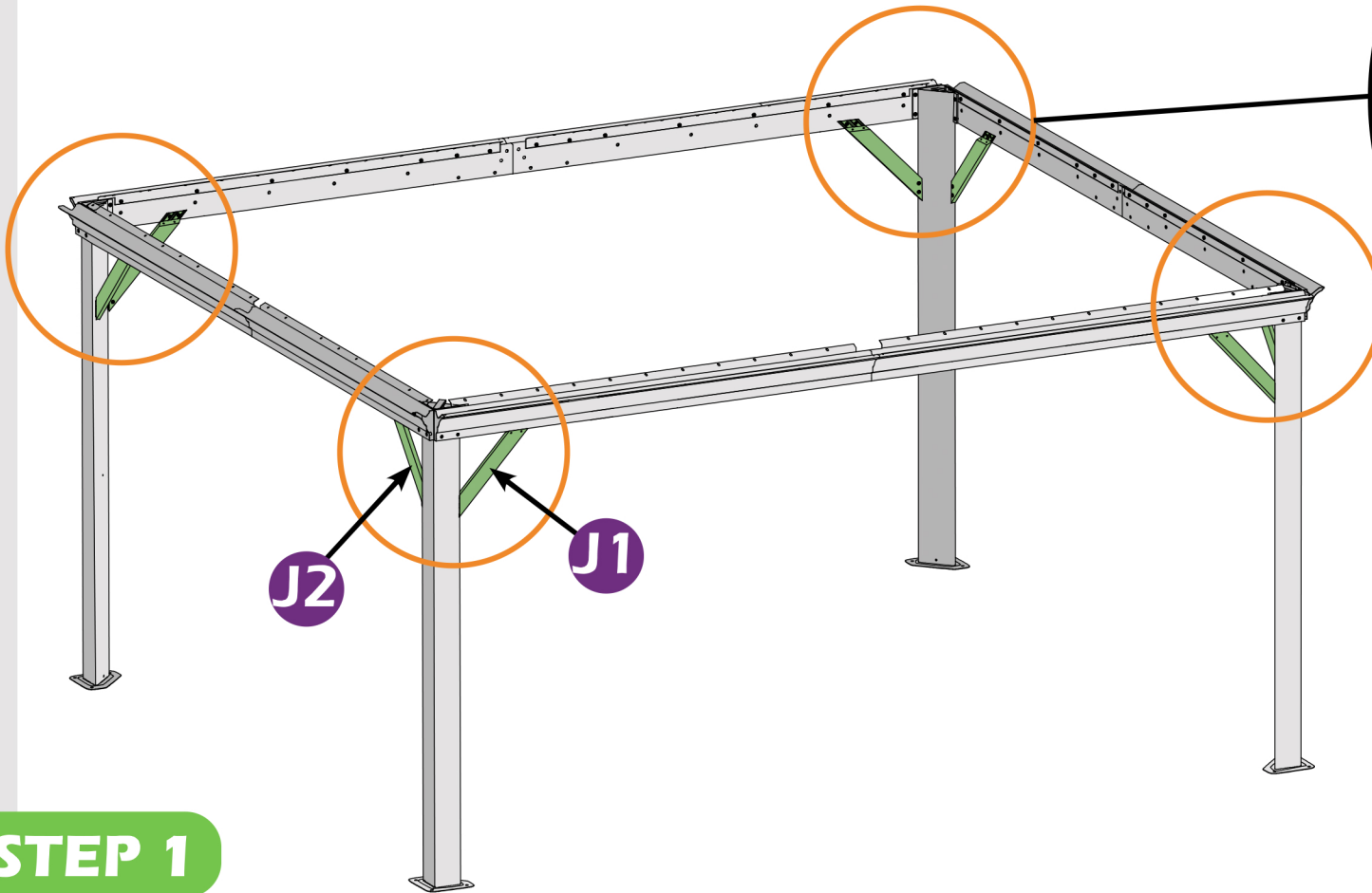

STEP 1

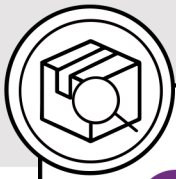

G × 4

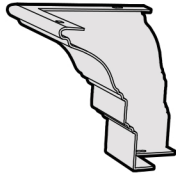

9# × 16

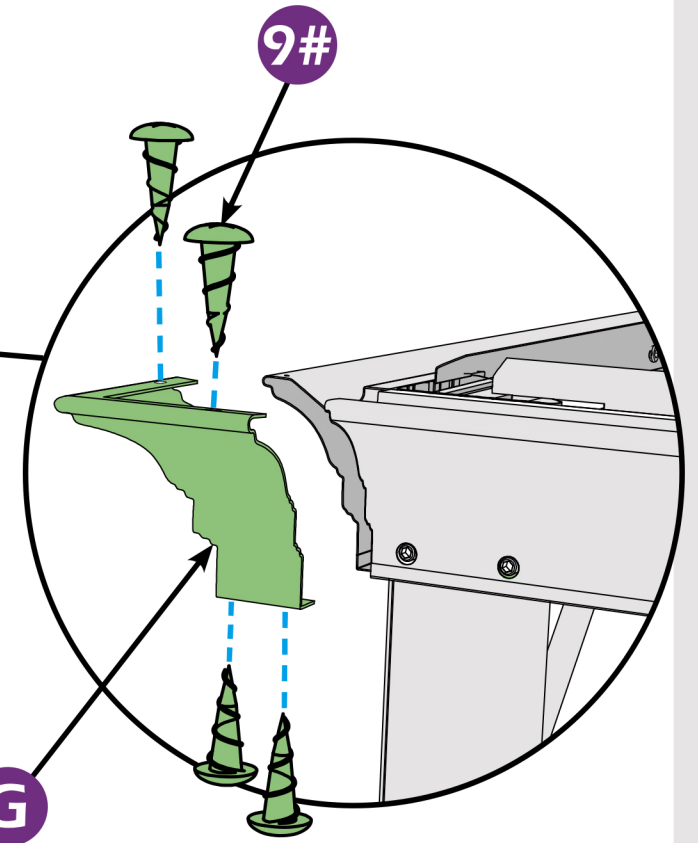
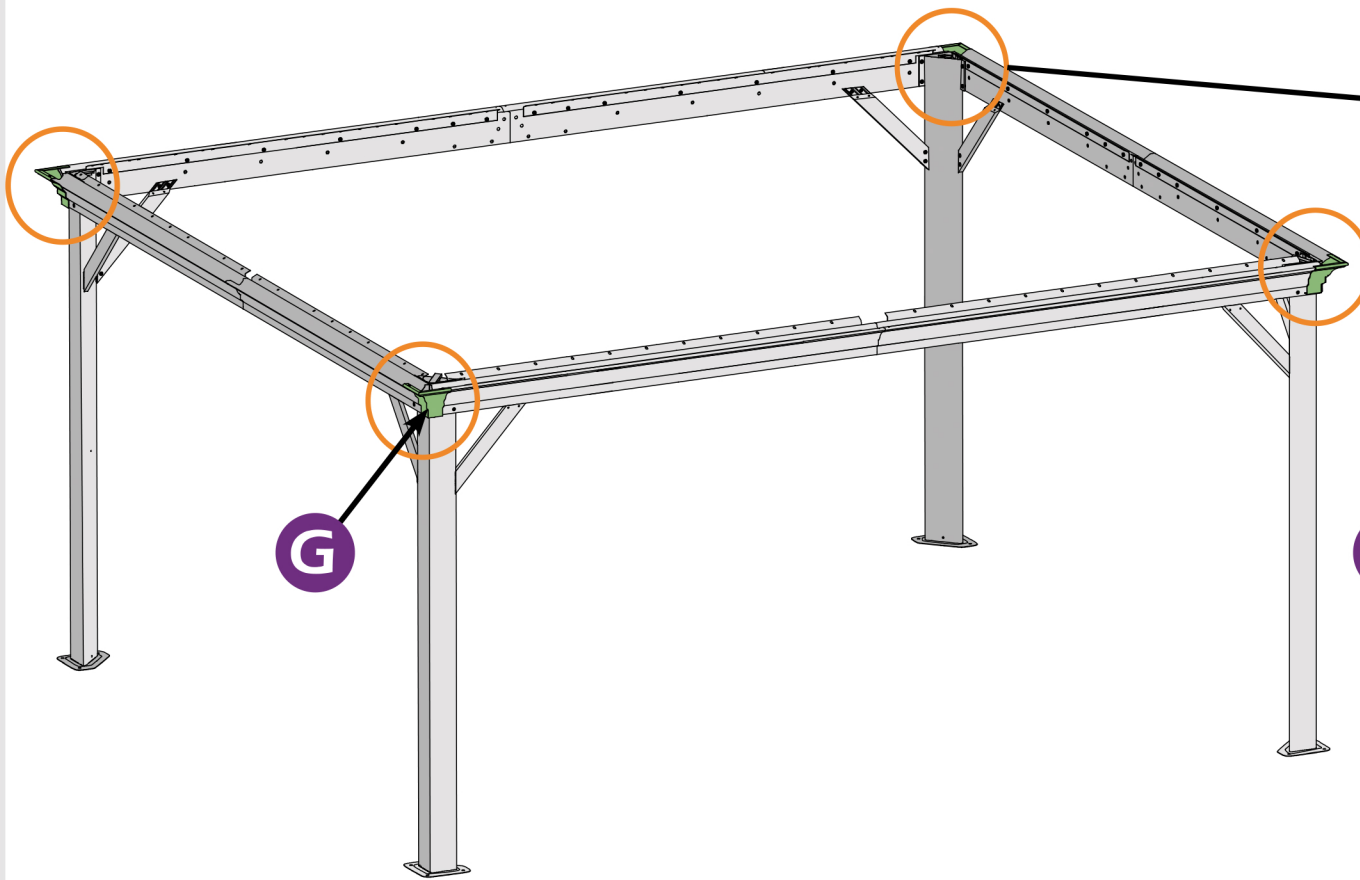
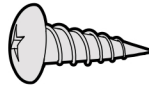

STEP 1

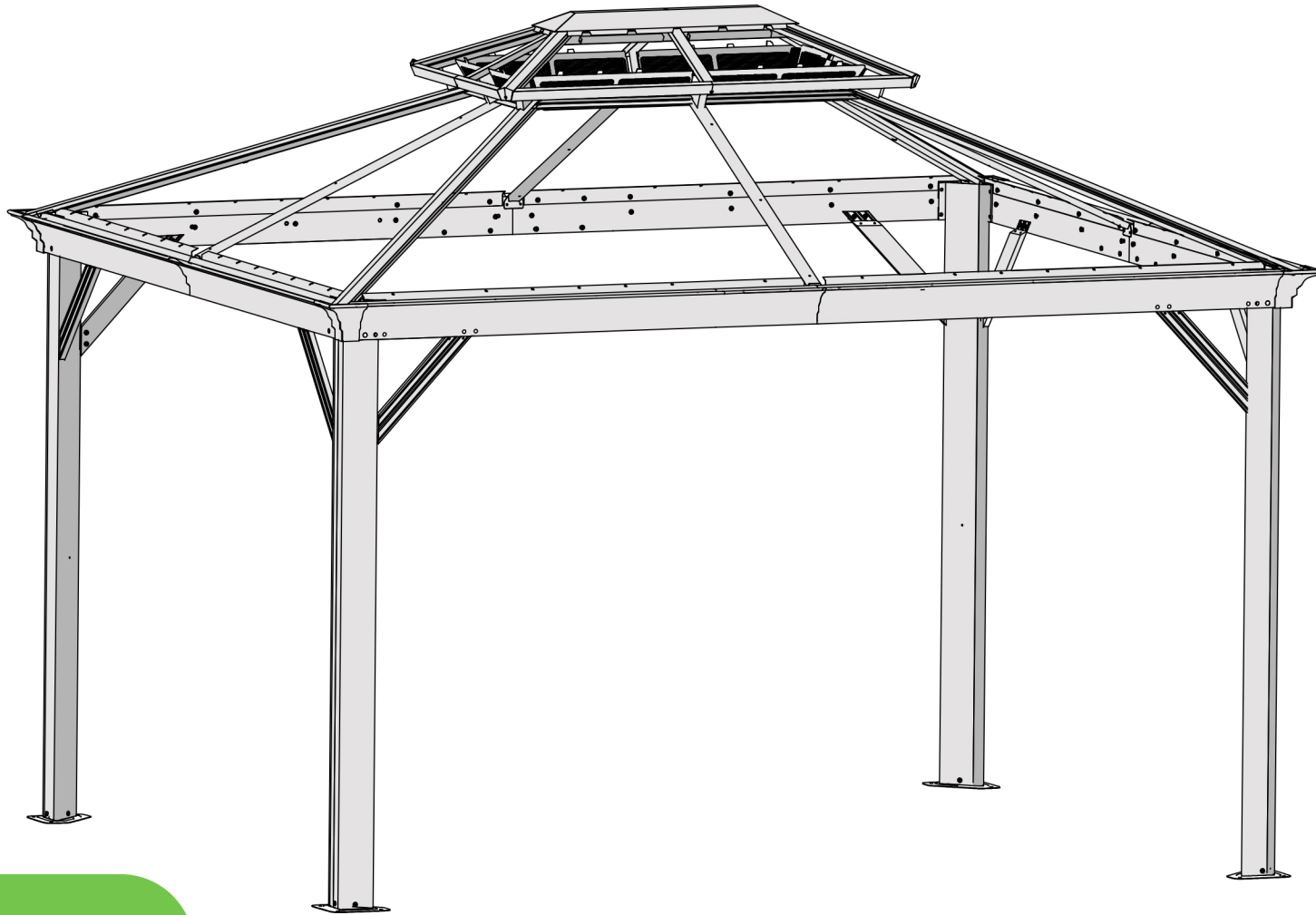

STEP 2

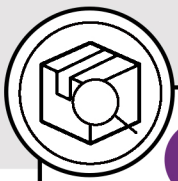

K × 1

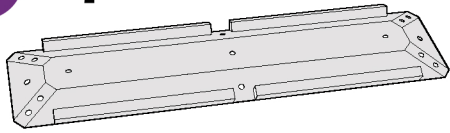

K1 × 1

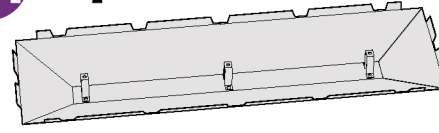

1# × 3

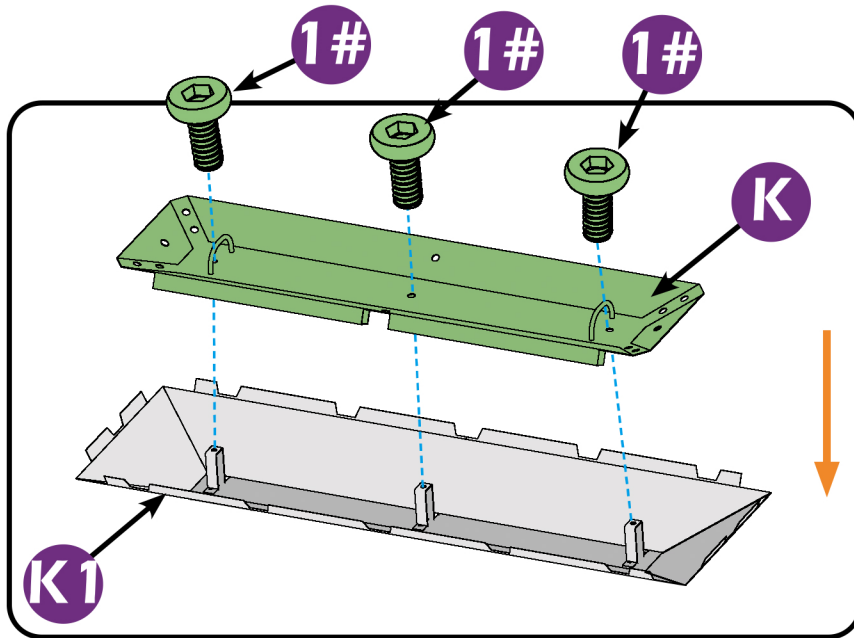
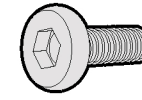

Don't fully tighten the screw **1#**, It might cause problem on roofs installation.

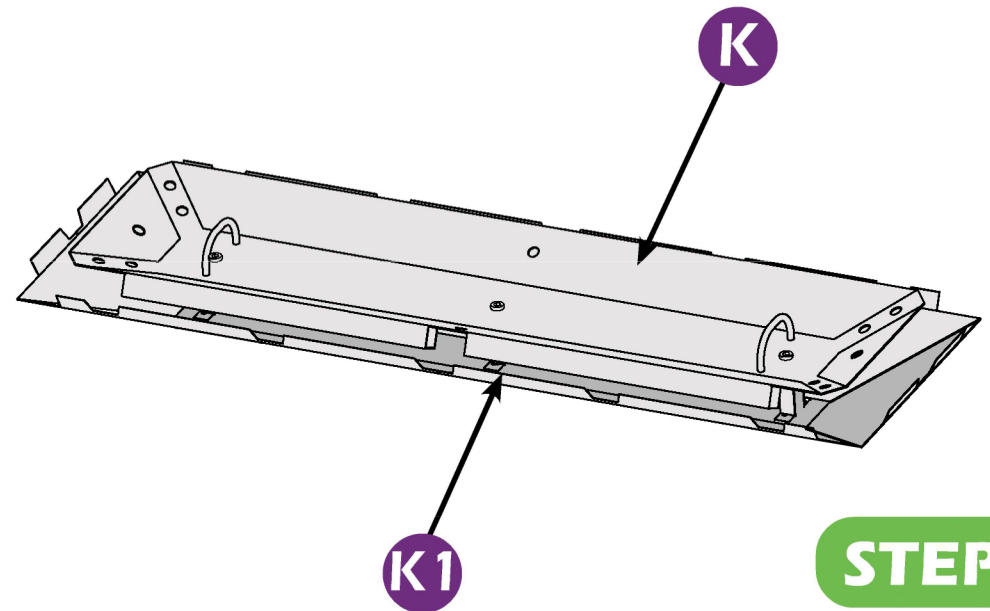

STEP 2



M × 1



N × 1



1# × 3

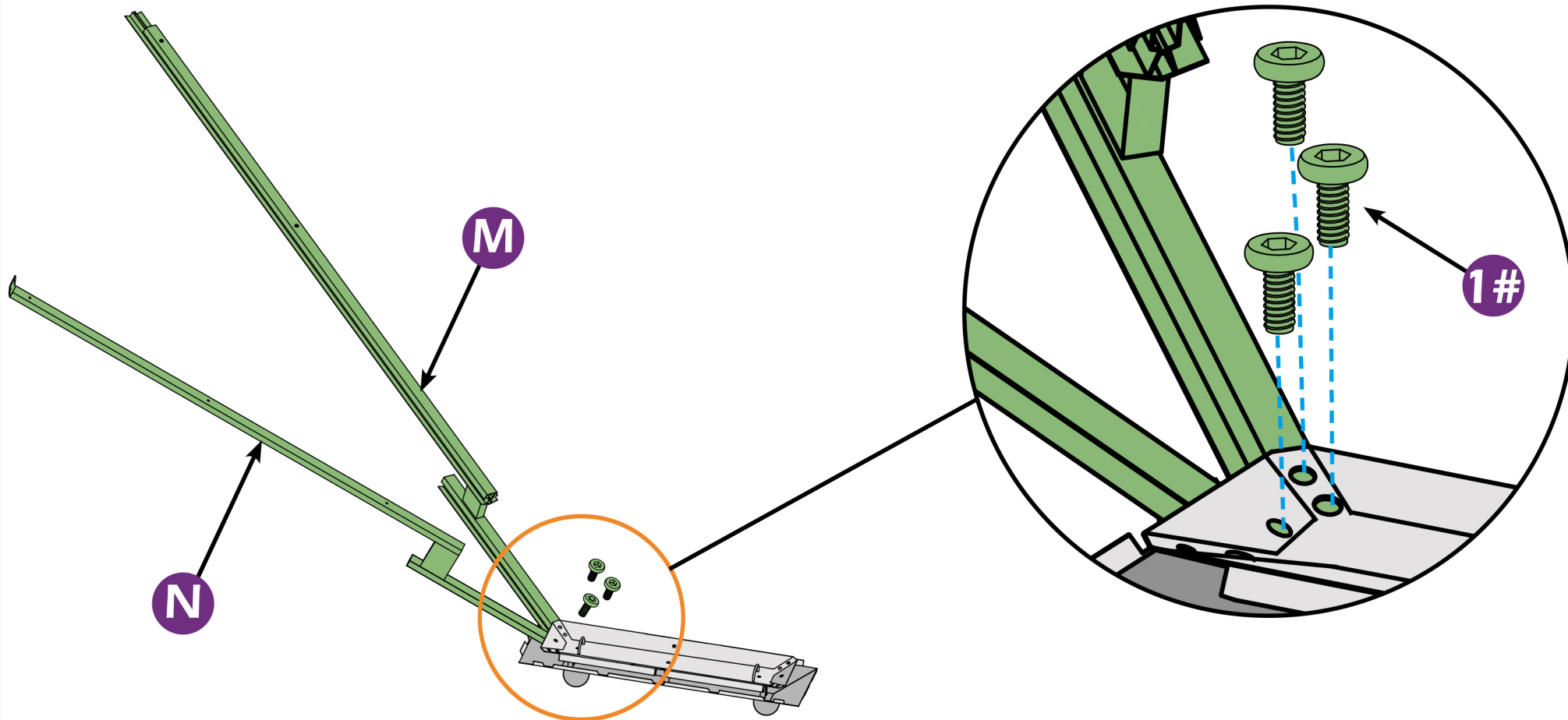
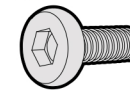

STEP 2

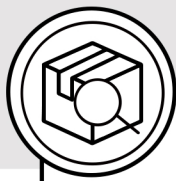

1# x 3

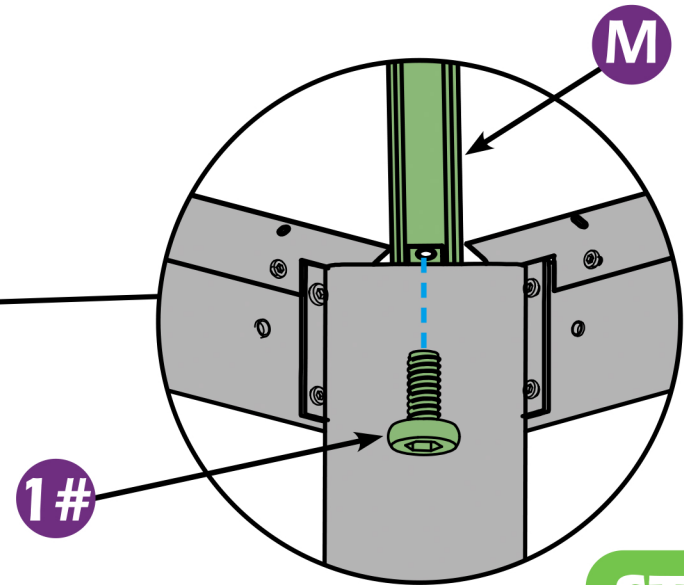
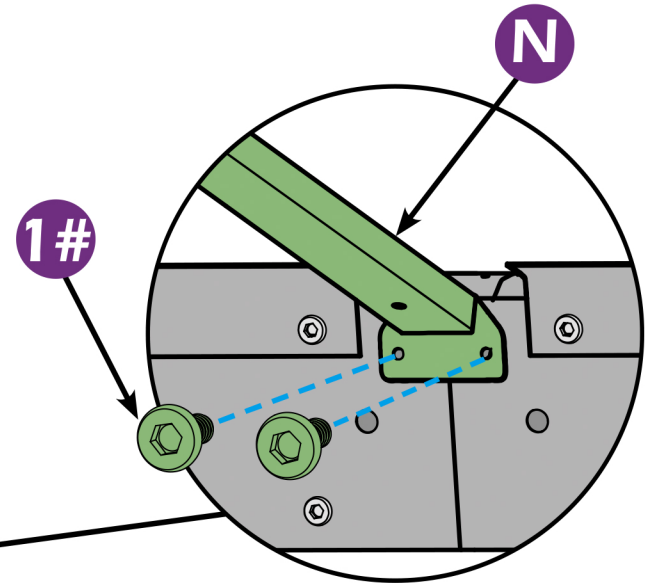
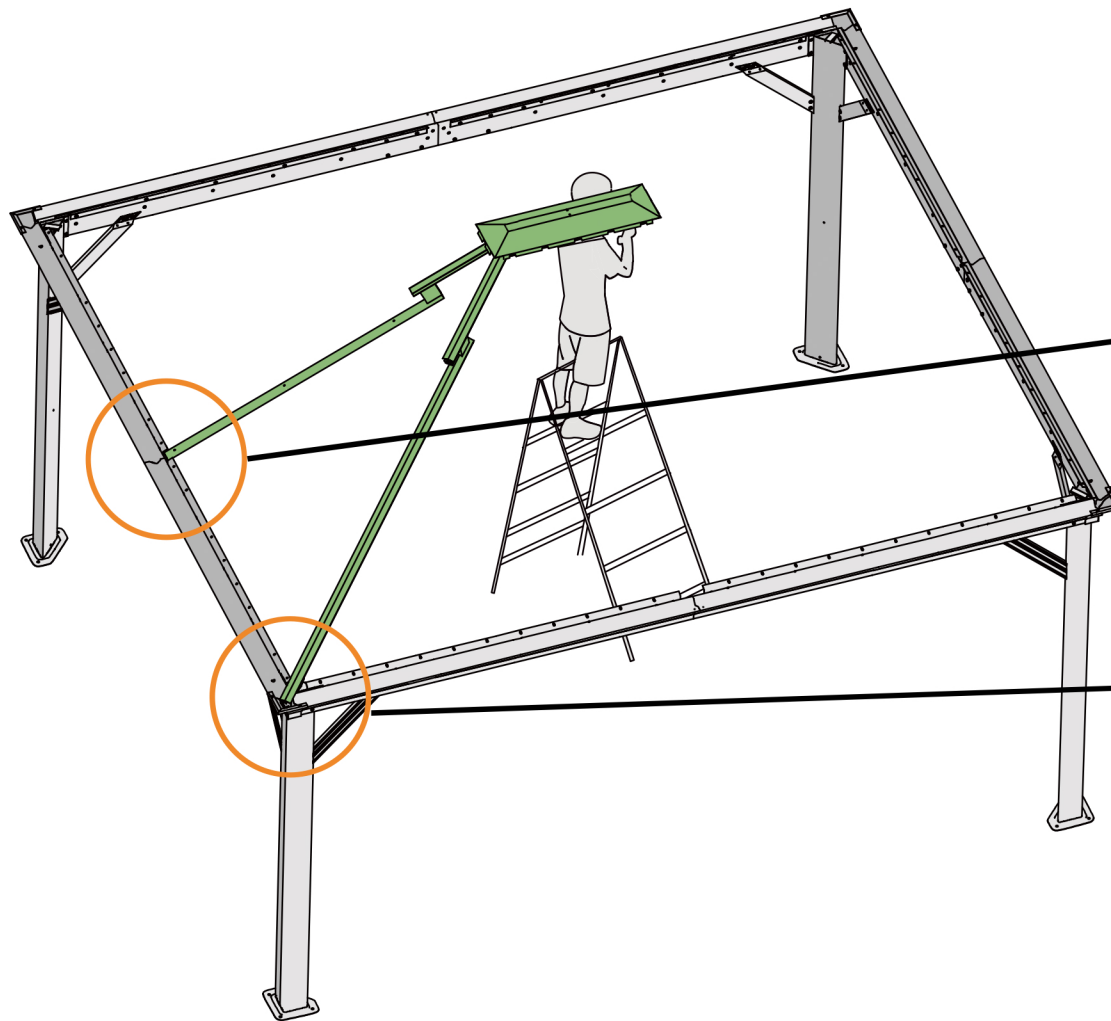
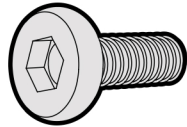

STEP 2

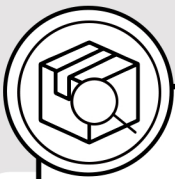

M × 3

1# × 9

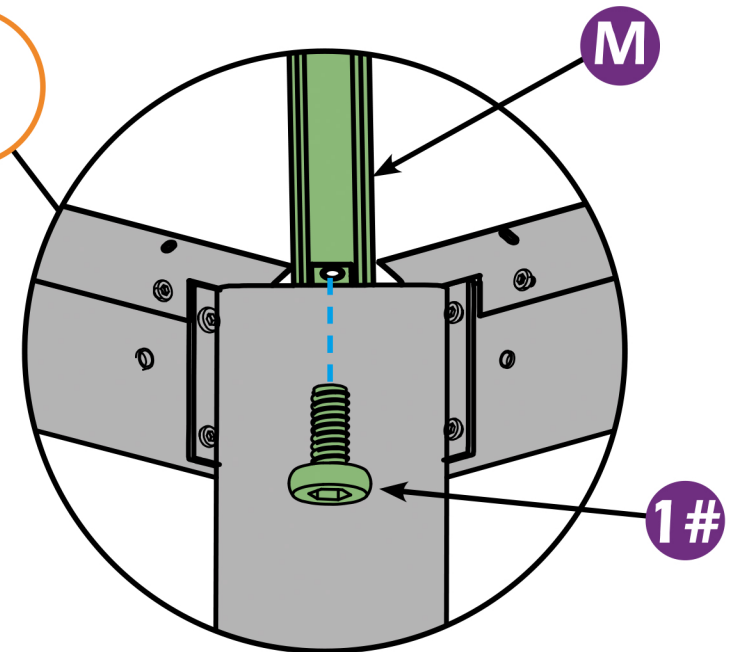
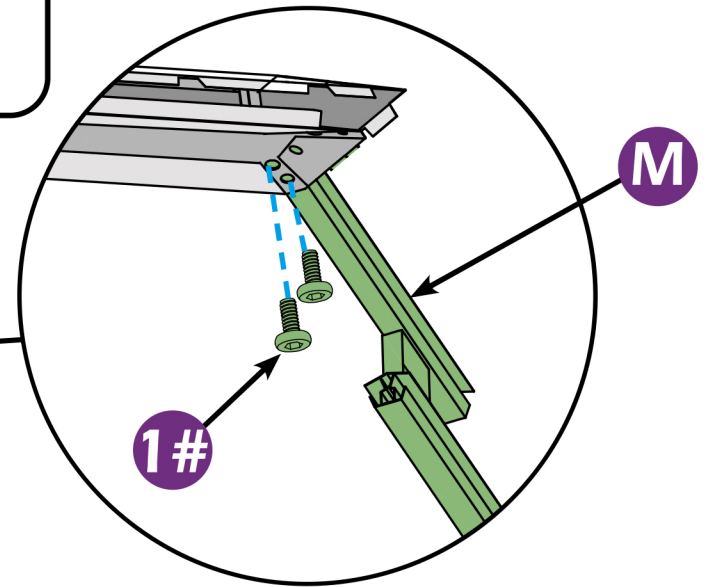
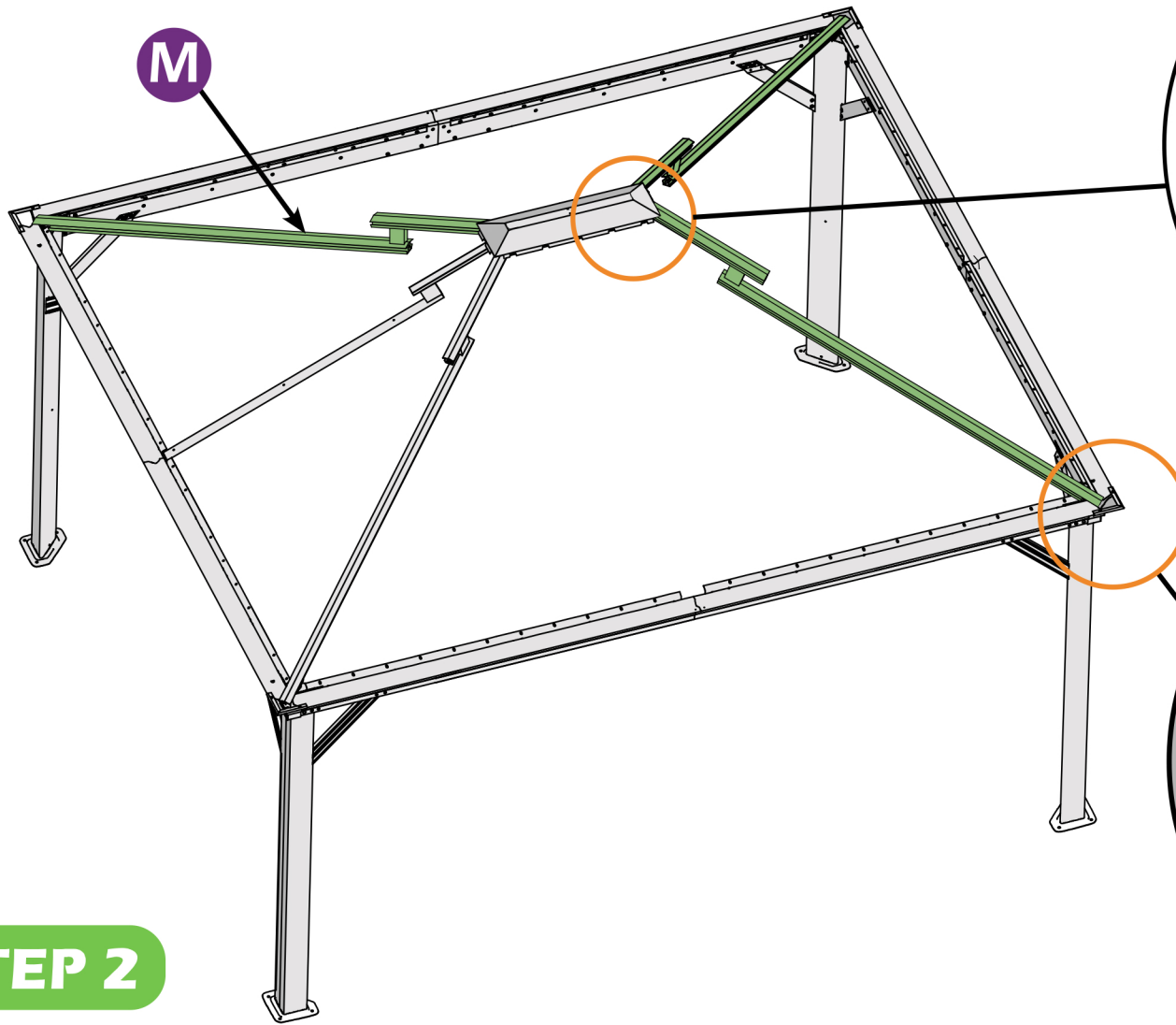
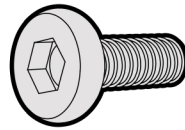

STEP 2

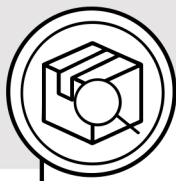

N × 1



1# × 3

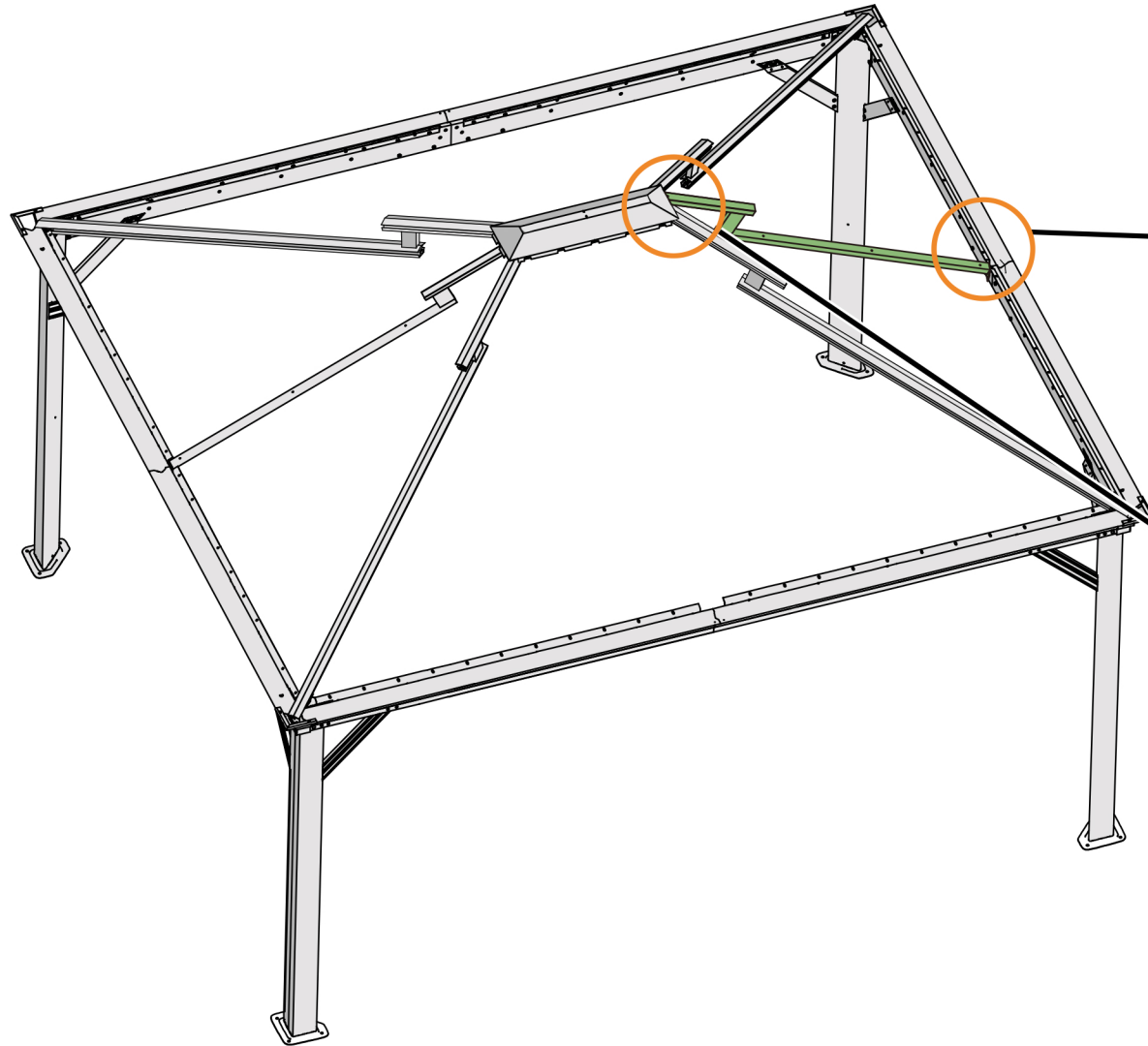
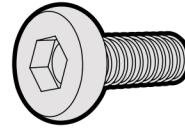

1#

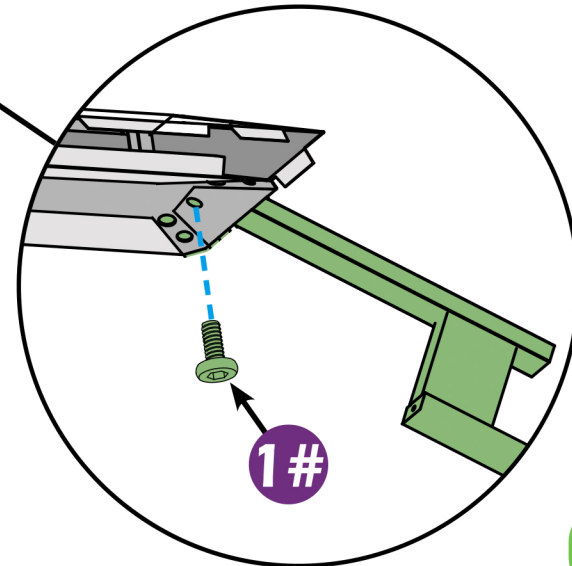
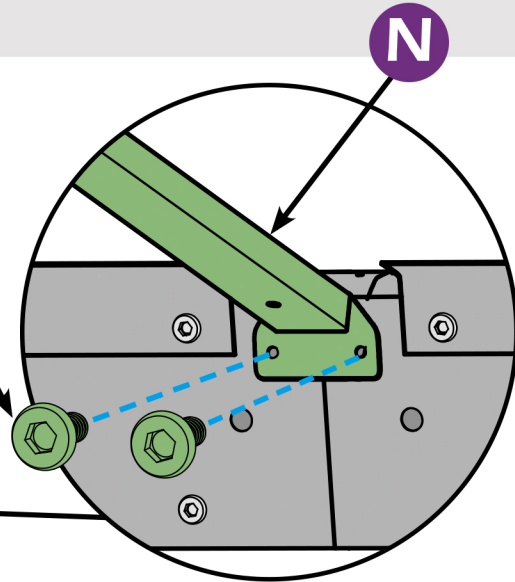

STEP 2

Check the the frame as pictures below shows.

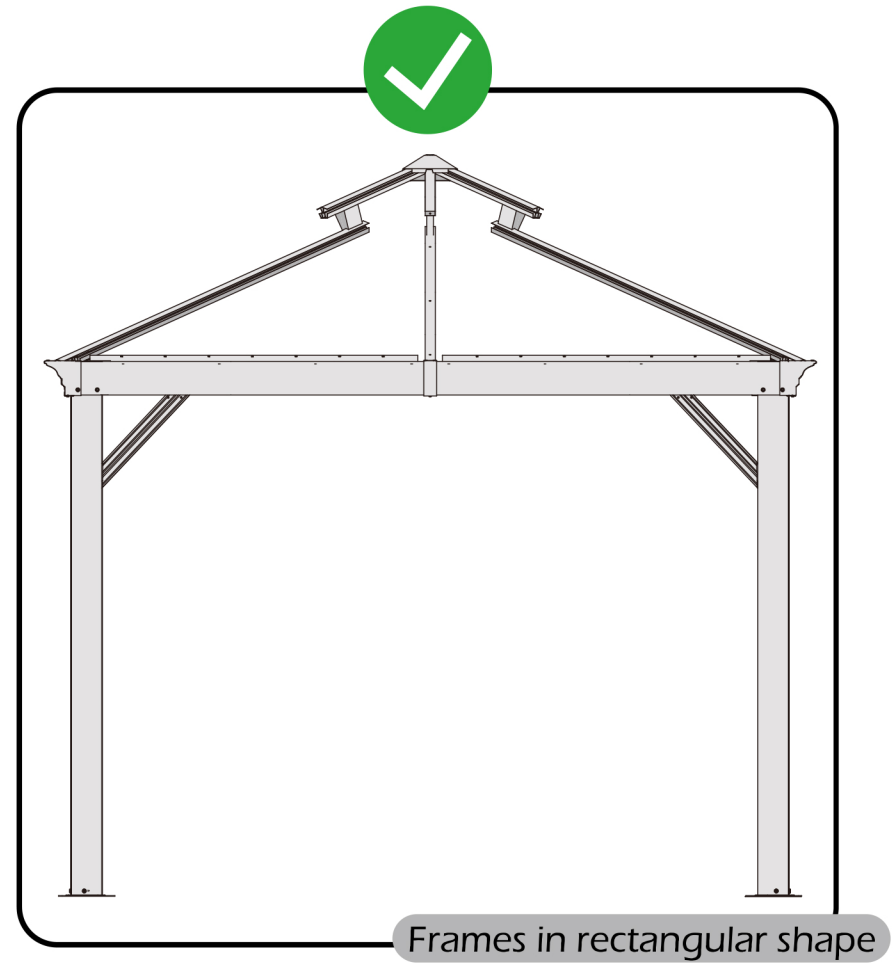
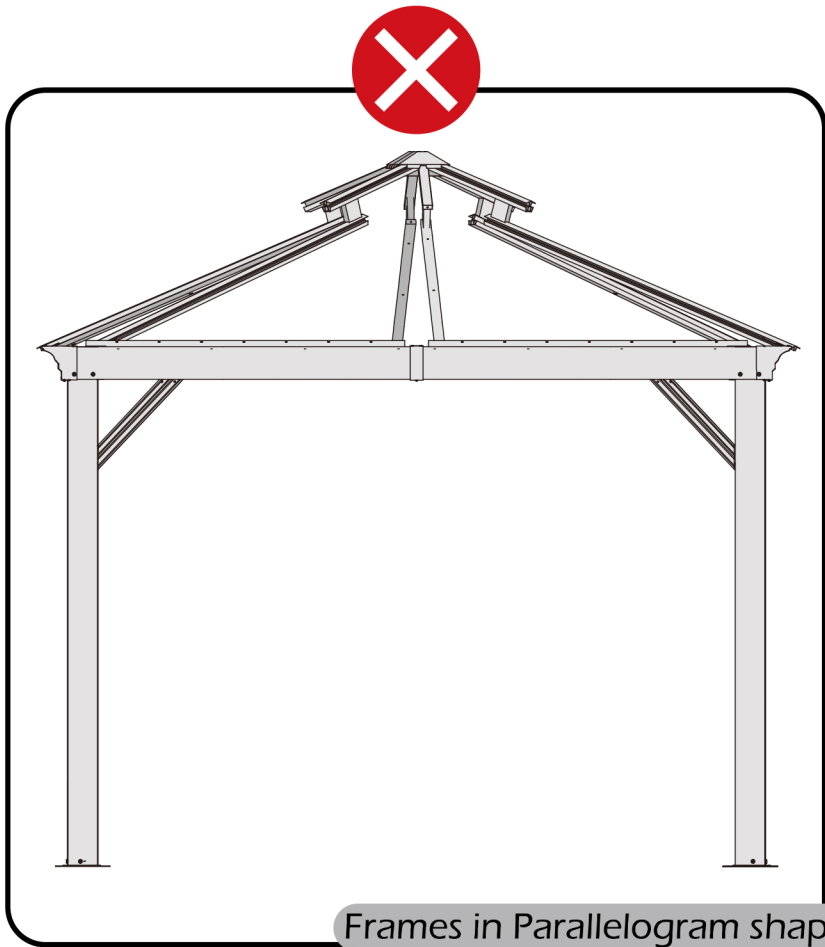

STEP 2

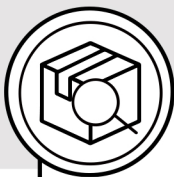

N × 2



1# × 6

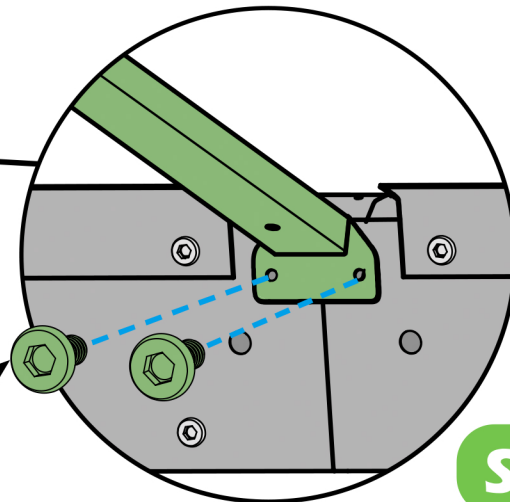
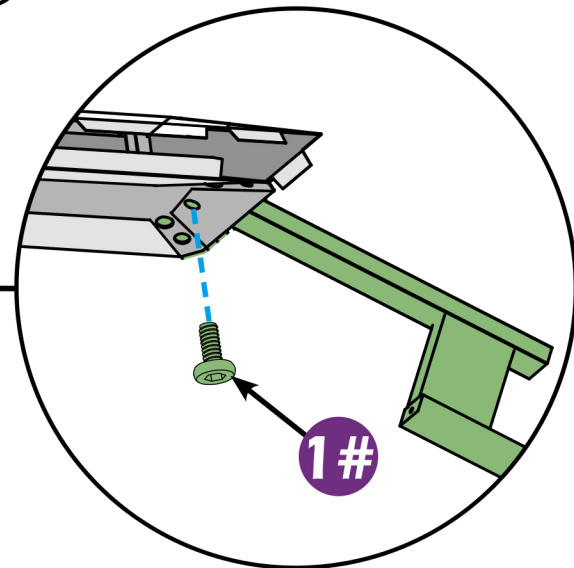
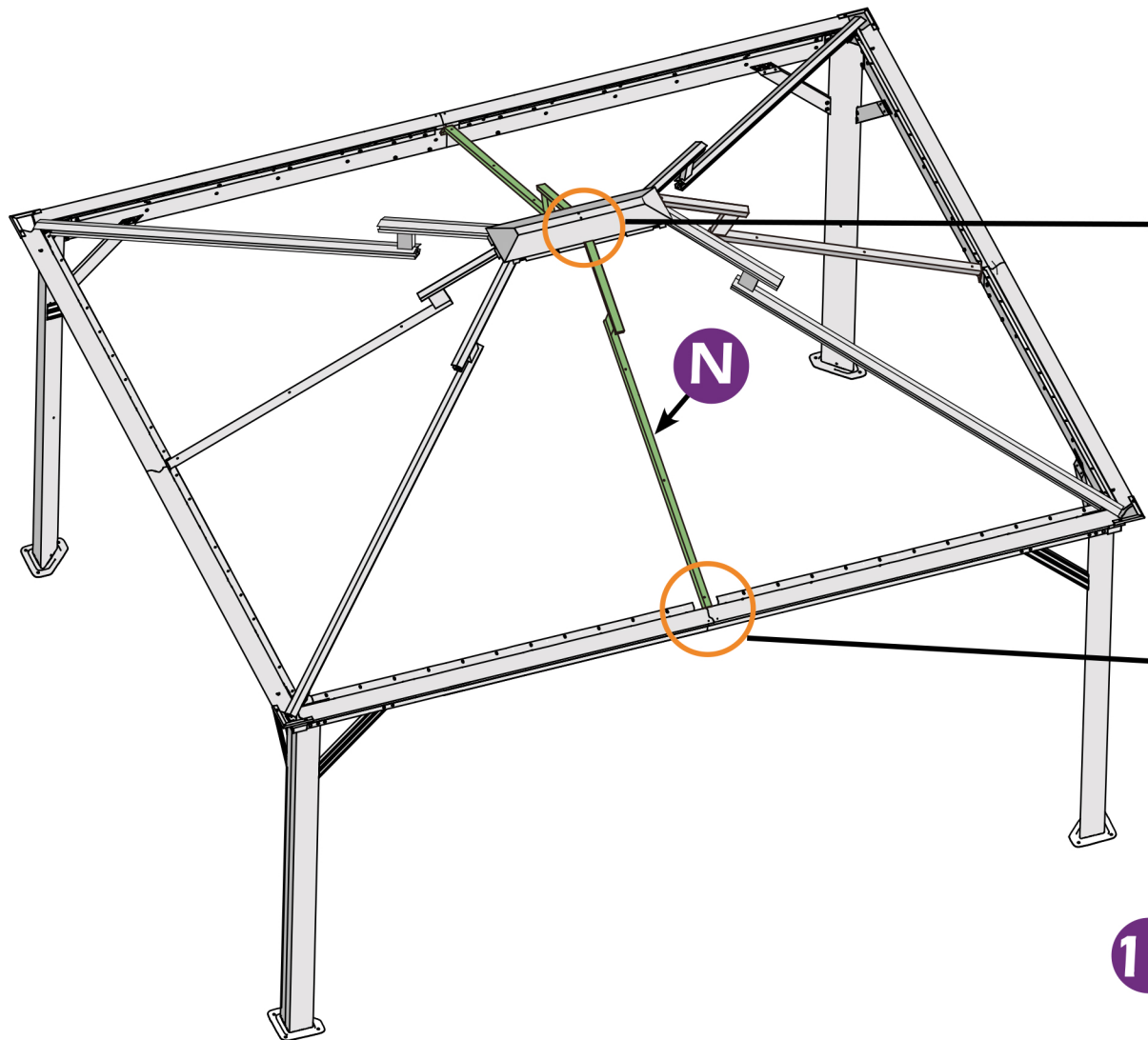
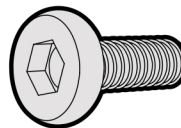

STEP 2

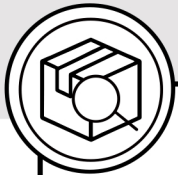

P × 2

R × 4

1# × 4

Q × 2

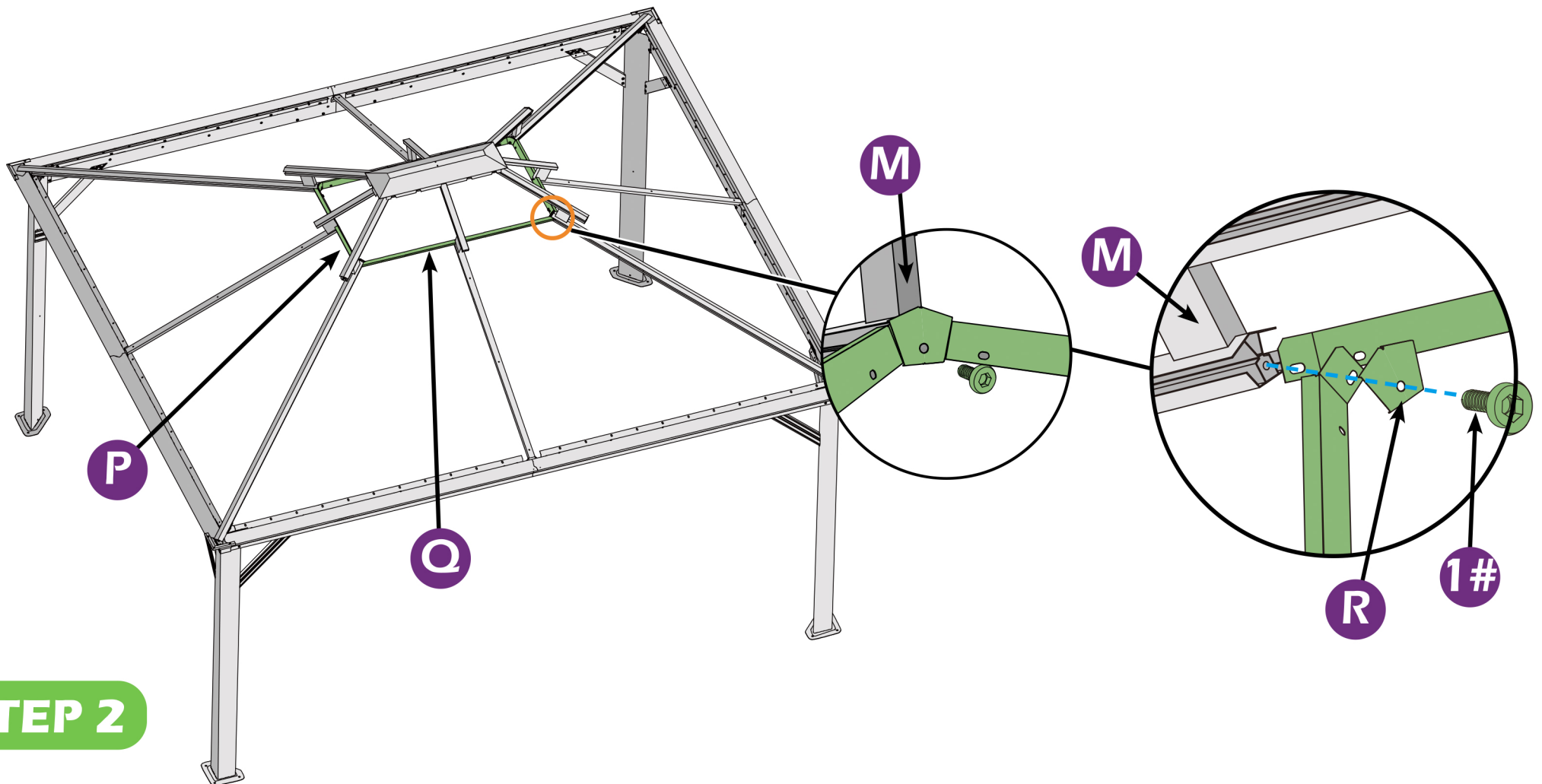

STEP 2

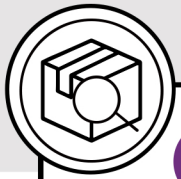

P1 × 2

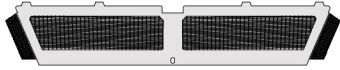

Q1 × 2

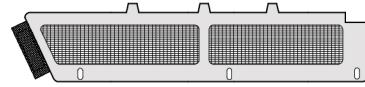

Q2 × 2

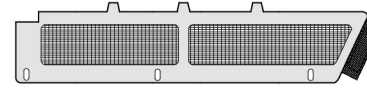

1# × 4

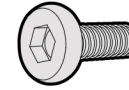

11# × 12

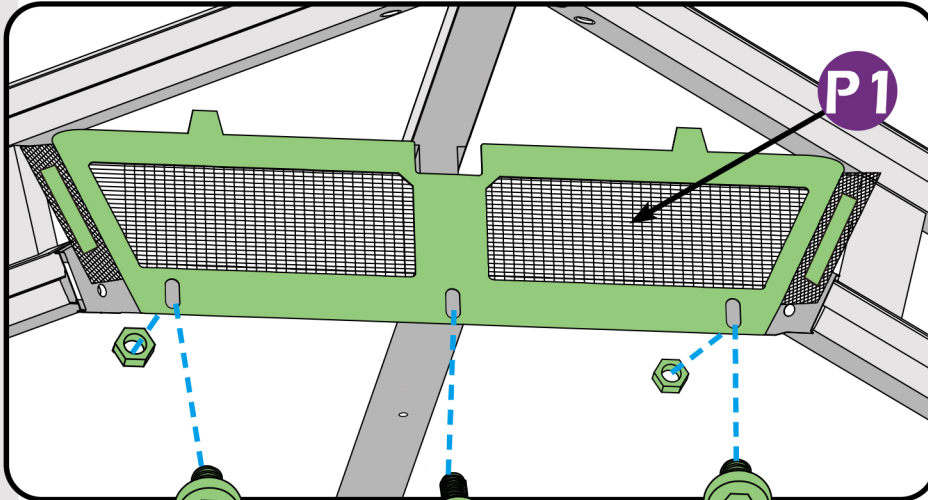
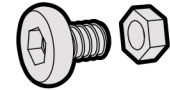

11#

1#

11#

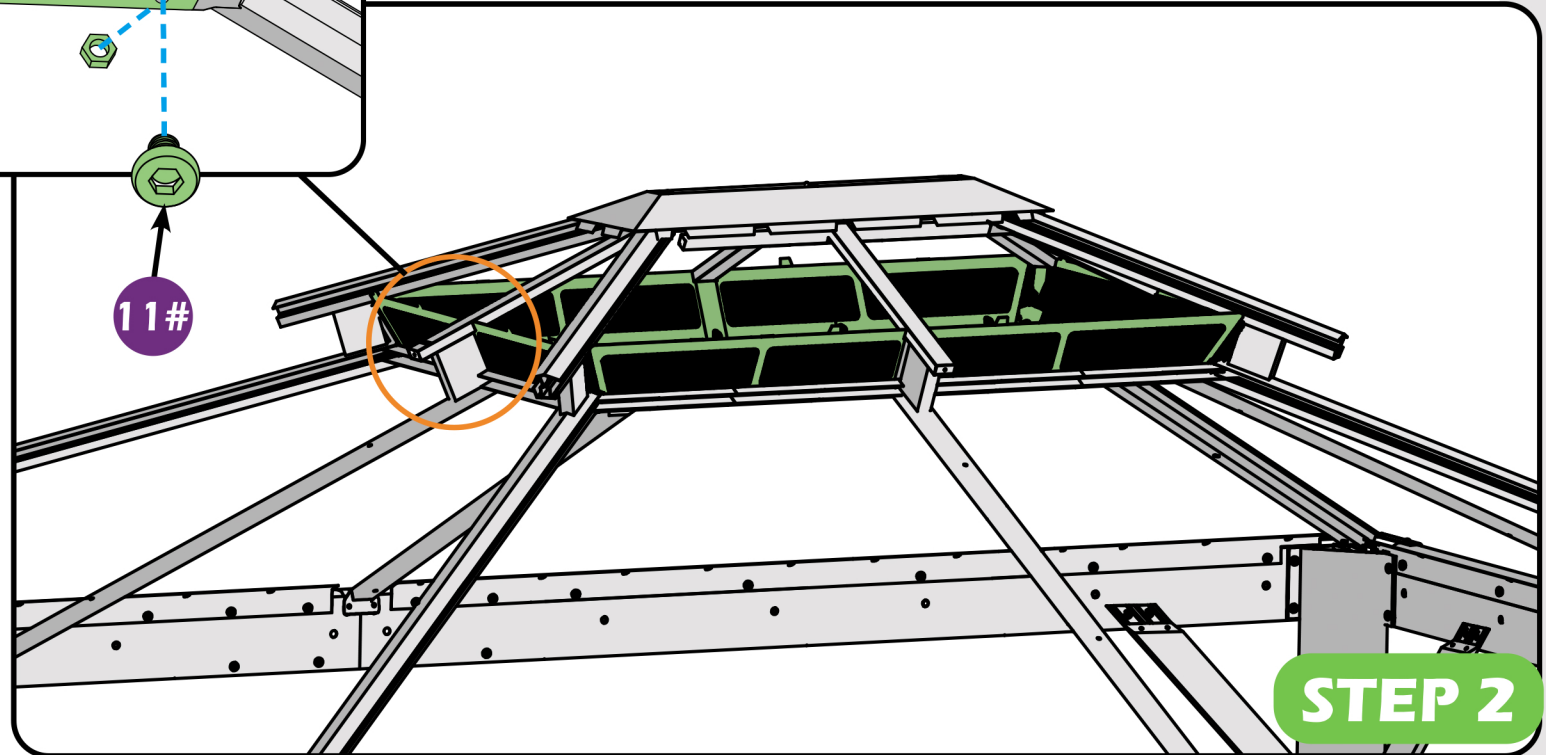

STEP 2

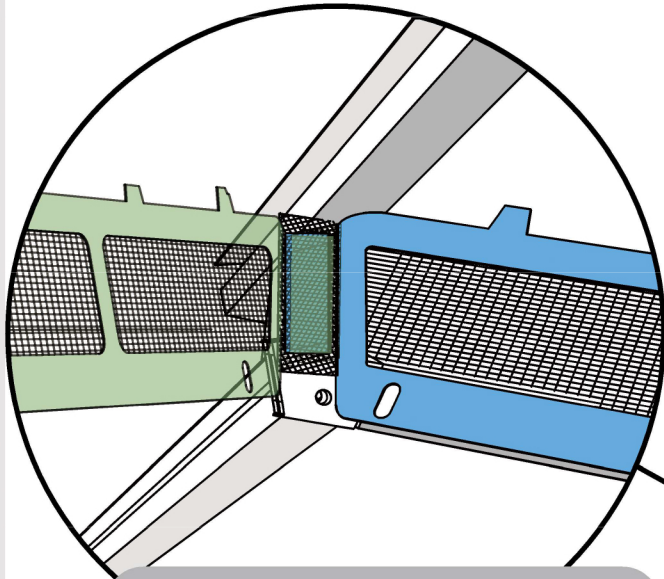
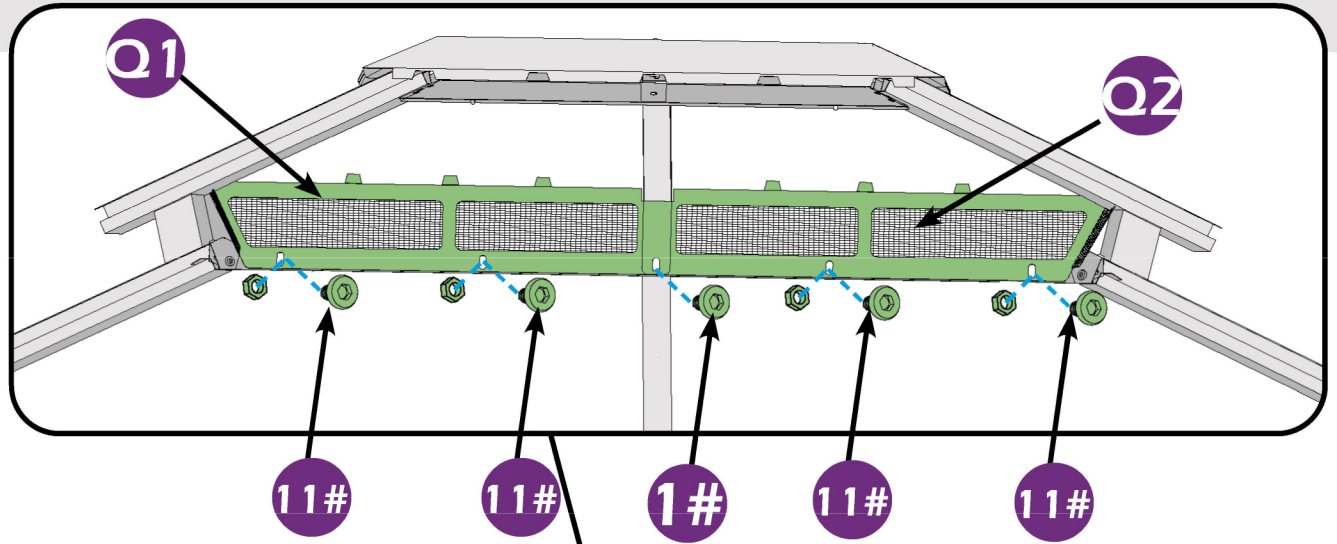

Don't forget to stick the velcro between the bug netting

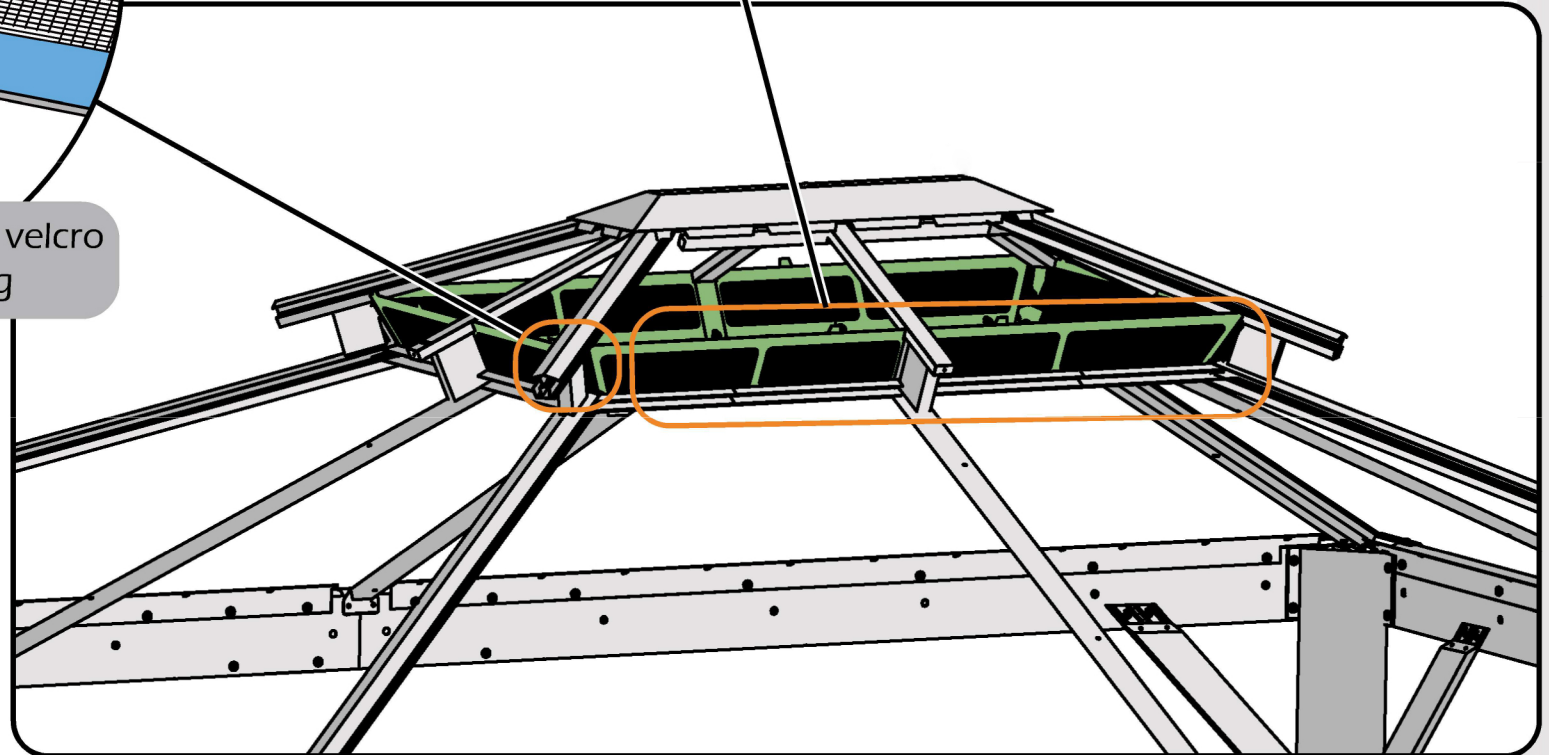

STEP 2

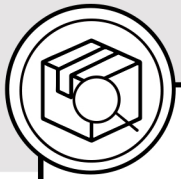

T1 × 2

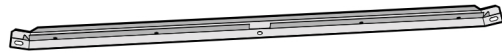

T2 × 2

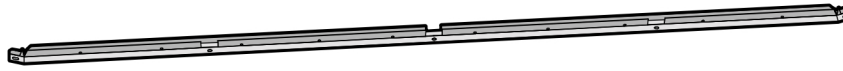

R × 4

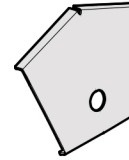

1# × 8

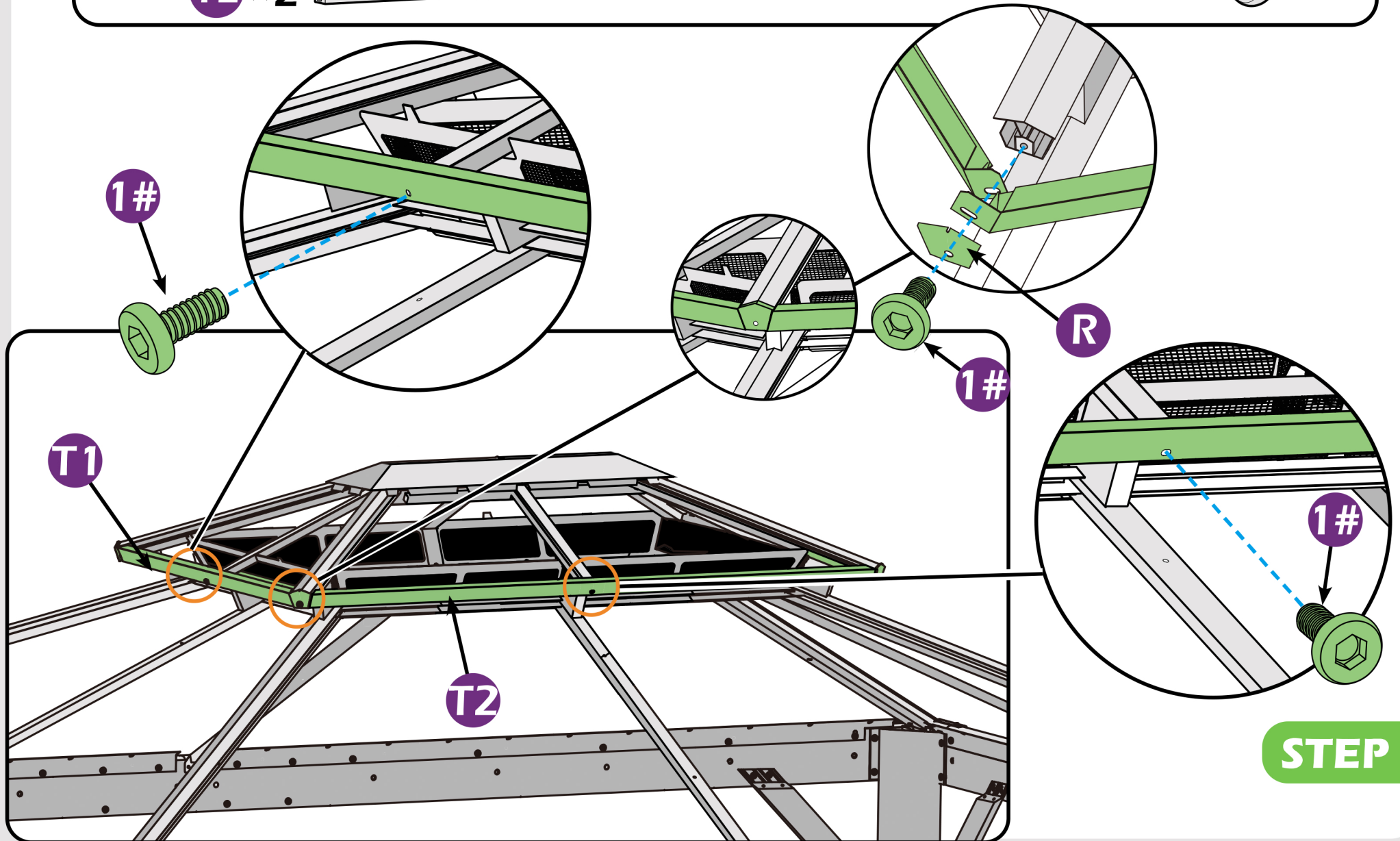
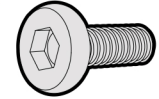

STEP 2