

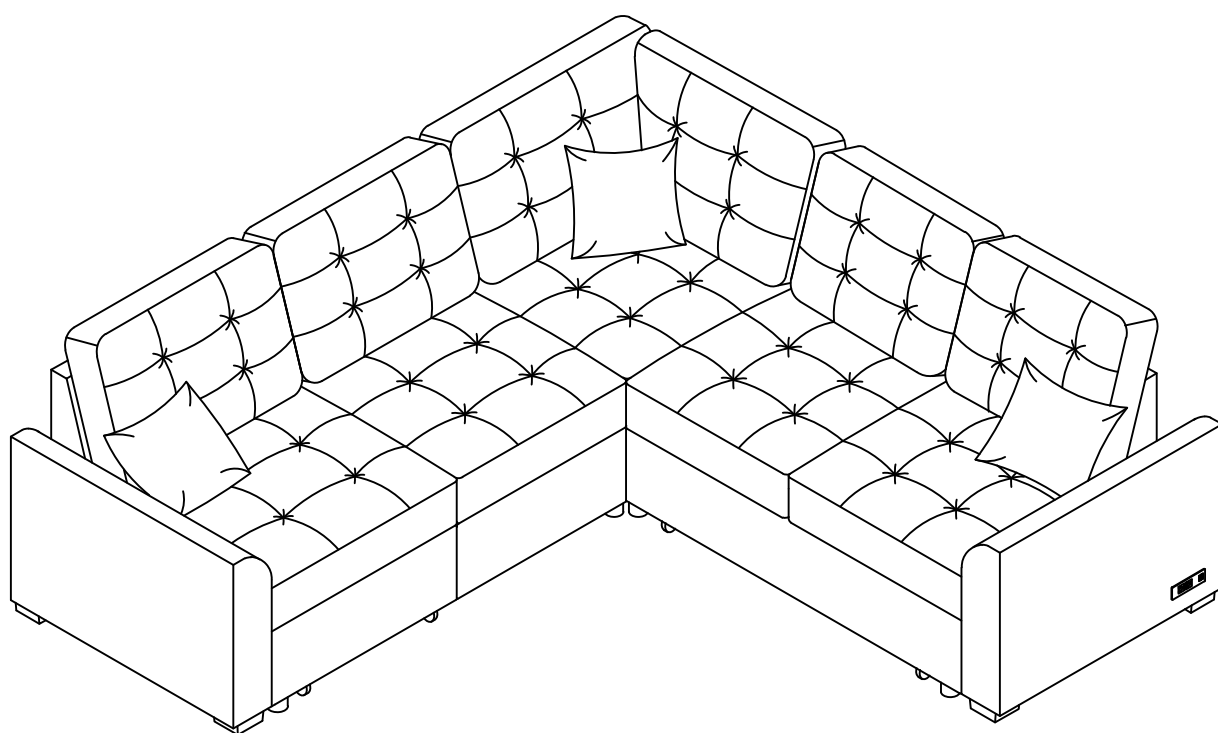











ASSEMBLY INSTRUCTION

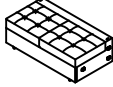







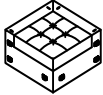

COMPONENT LIST

NO.	DRAWING	QTY	DESCRIPTION
B		1	Loveseat Body
E		1	Corner Short Backrest
I		4	Round legs
K		3	Back Cushion



COMPONENT LIST

G		1	Loveseat Body
C		1	Loveseat Backrest
J		1	Loveseat Backrest
N		3	Pillow
I		4	Round legs
Q		1	Allen key
S		16	Bolt Ø1/4"x20MM
R		8	Wheel

COMPONENT LIST

D		1	Corner Frame
F		1	Long Corner Backrest
K		1	Back Cushion
L		1	Long Corner Back Cushion
M		1	Short Corner Back Cushion
I		4	Round legs
O		4	Square Leg
P		8	Bolt 5/16"X50mm

COMPONENT LIST

A		1	Left Arm
H		1	Right Arm

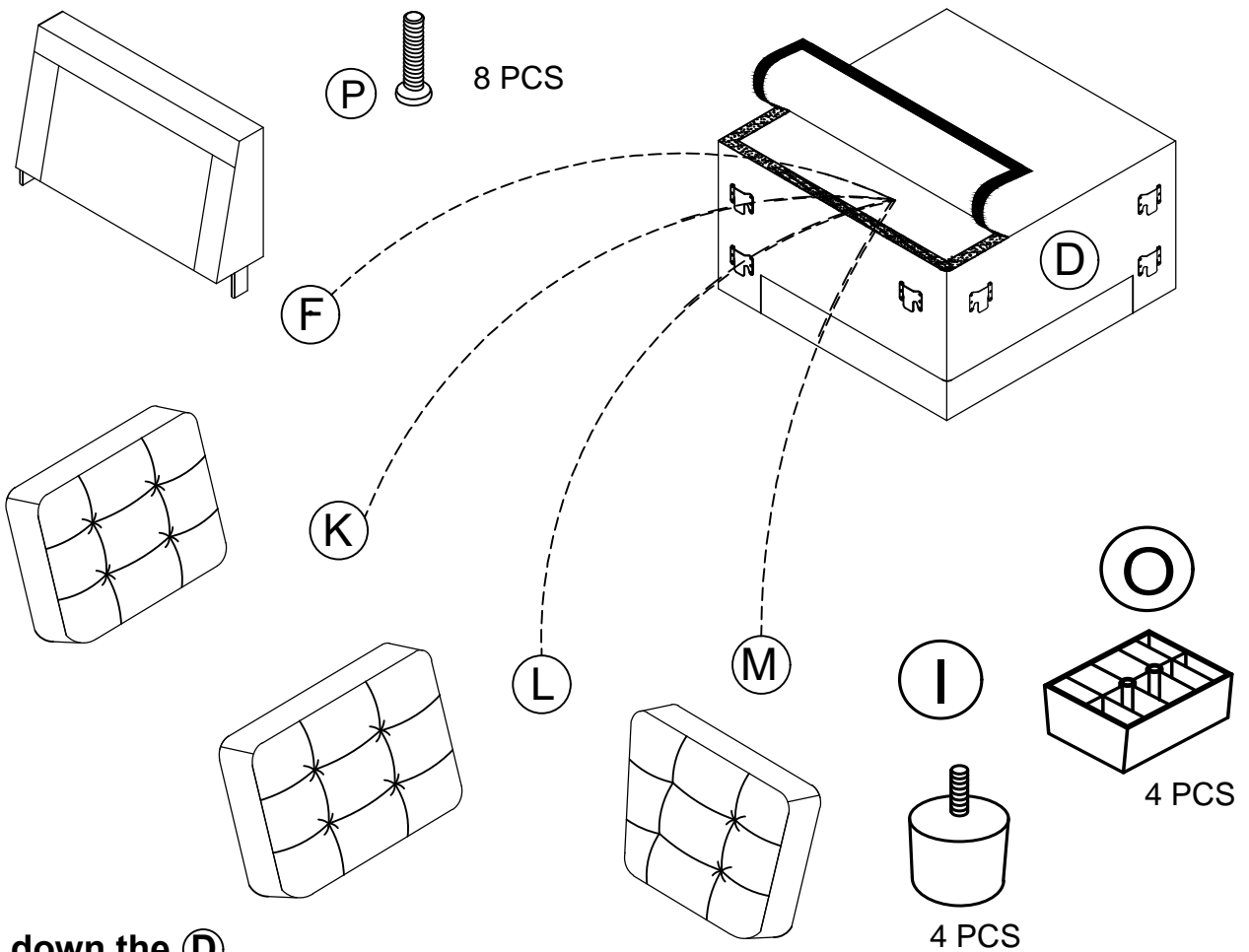

* Turn upside down the **(D)**
 ** Take out the **(F, K, L, M, I, O, P)**

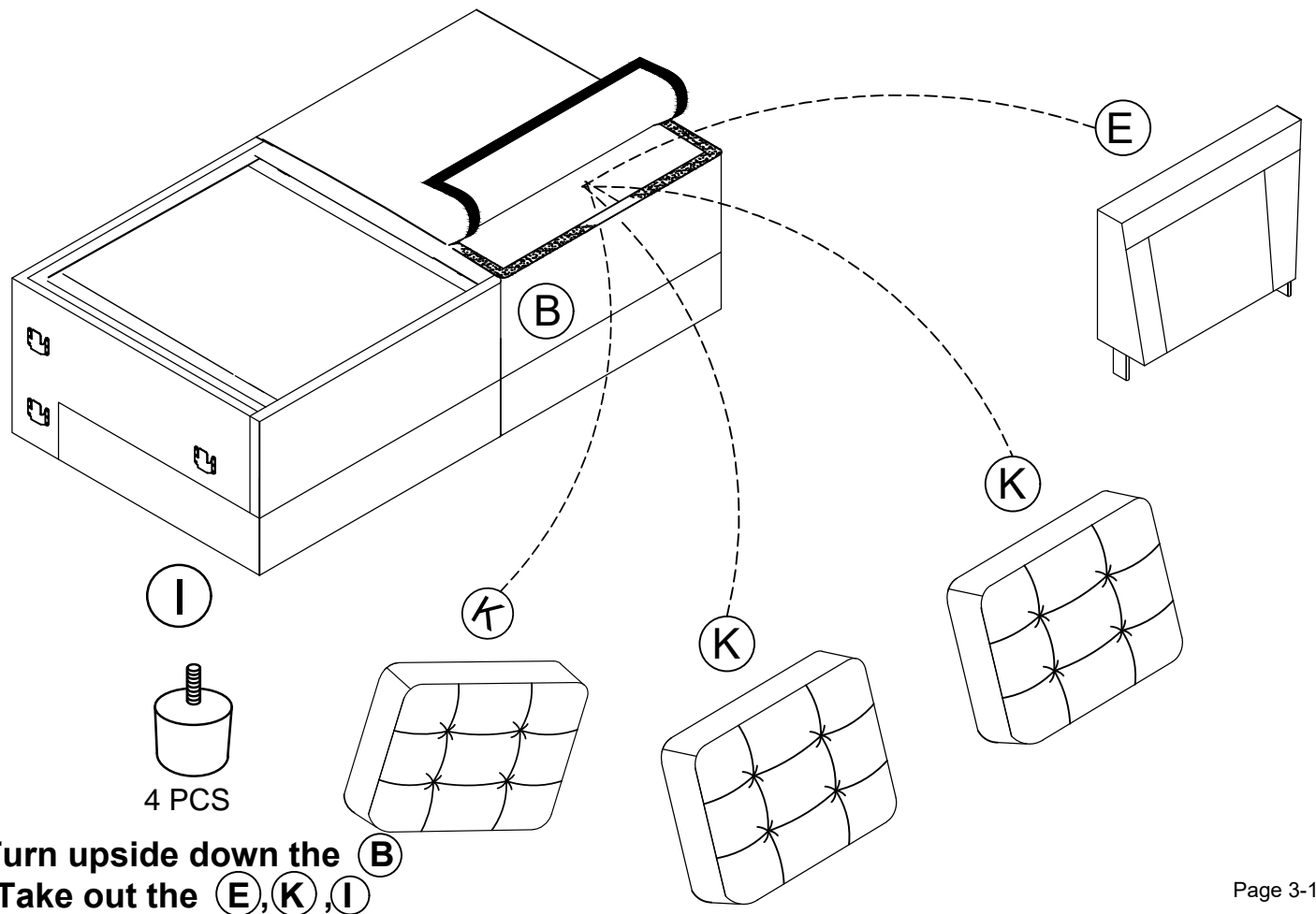

* Turn upside down the **(B)**
 ** Take out the **(E, K, I)**

PARTS LIST

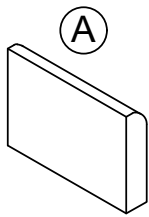
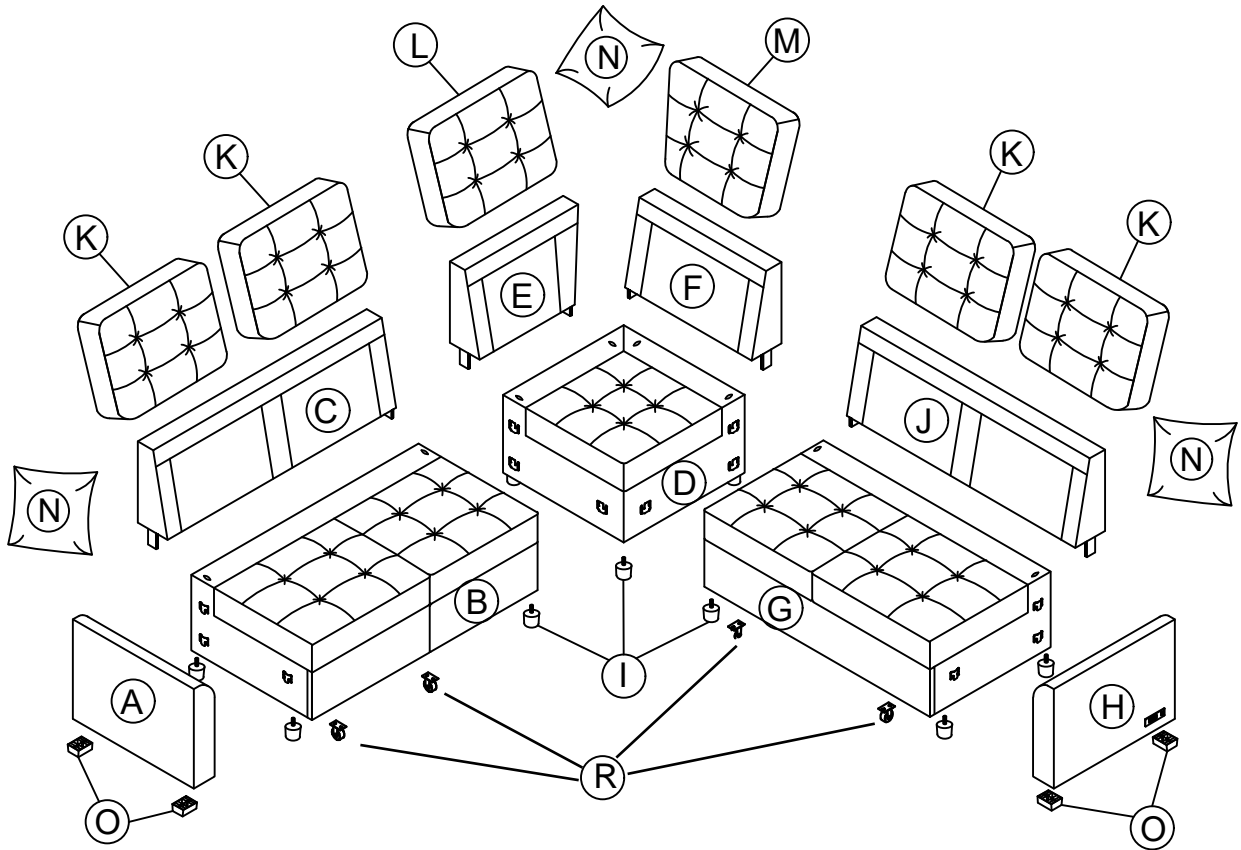

Left Arm
X 1PC

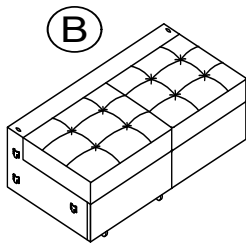

Loveseat Body
X 1PC

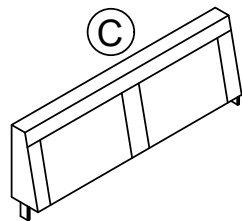

Loveseat Backrest
X 1PC

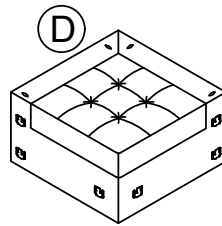

Corner Frame
X 1PC

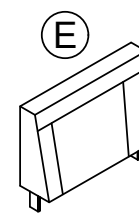

Corner Short
Backrest X 1PC

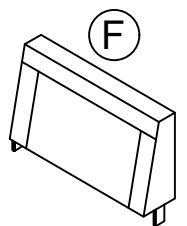

Long Corner
Backrest X 1PC

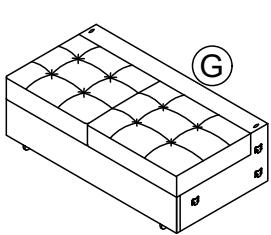

Loveseat Body
X 1PC

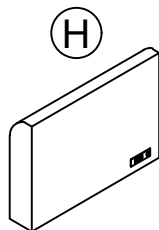

Right Arm
X 1PC

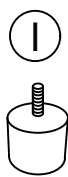

Round Leg
X 12 PCS

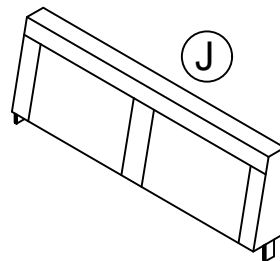

Loveseat Backrest
X 1PC

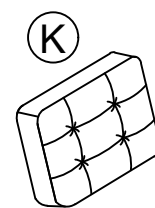

Back Cushion
X 4PCS

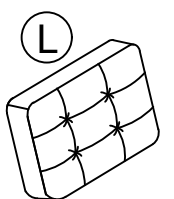

Long Corner
Back Cushion
X 1PC

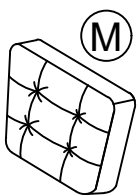

Short Corner
Back Cushion
X 1PC



Pillow
X 3PCS

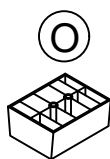

Square Leg
X 4PCS

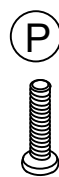

Bolt 5/16"X50mm
X 8PCS

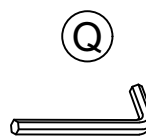

Allen key
1PC



Wheel
X 8 PCS



Bolt Ø1/4"x20MM
X 16 PCS

STEP 1:

- 1.1 Attach I x4 with Rx4 to B x1
- 1.2 Attach I x4 to D x1
- 1.3 Attach I x4 with Rx4 to G x1.

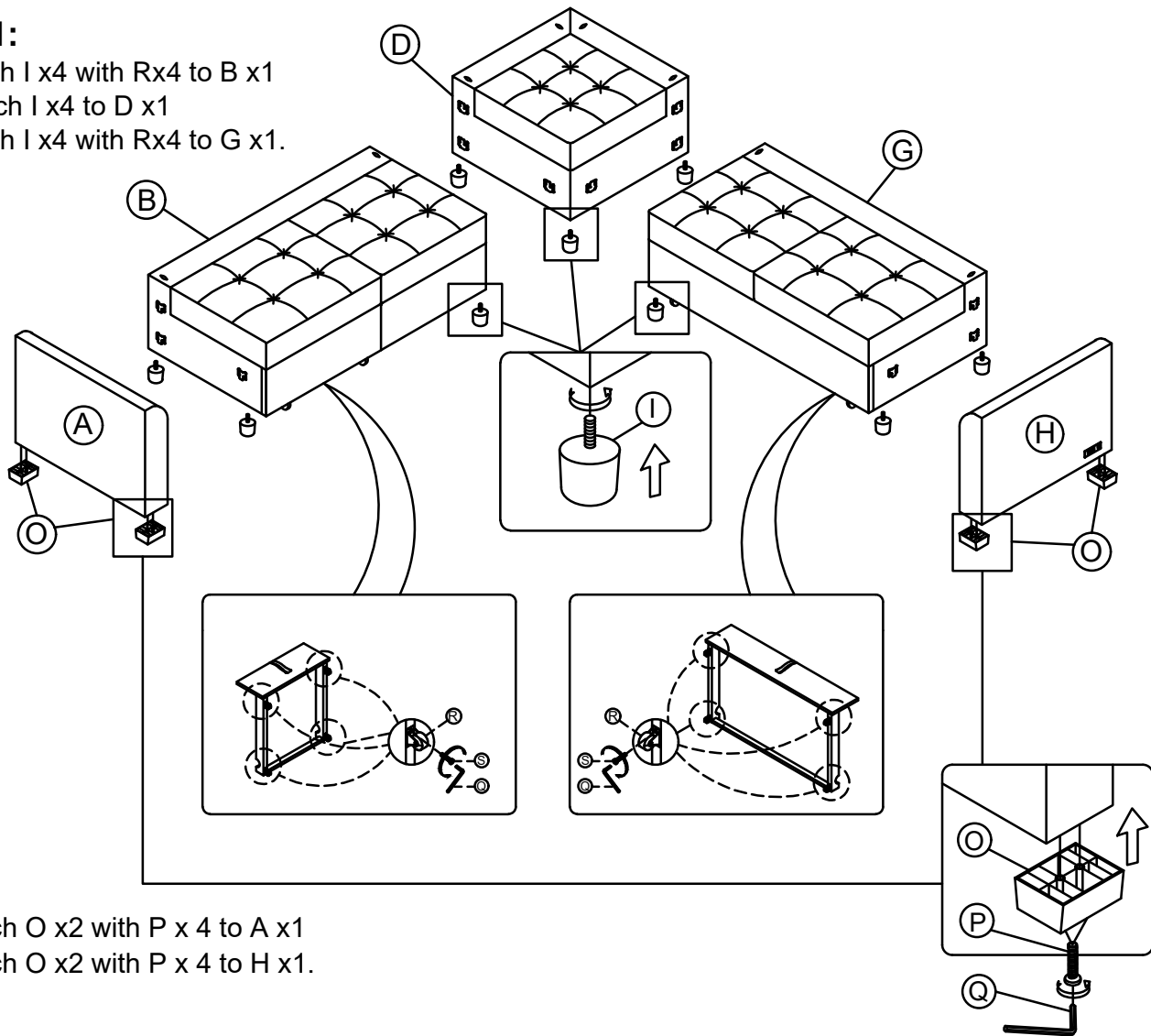

STEP 2:

- 2.1 Attach O x2 with P x 4 to A x1
- 2.2 Attach O x2 with P x 4 to H x1.

STEP 3:

- 3.1 Attach C x1 to B x1
- 3.2 Attach E x1 with F x1 to D x1
- 3.3 Attach J x1 to G x1.

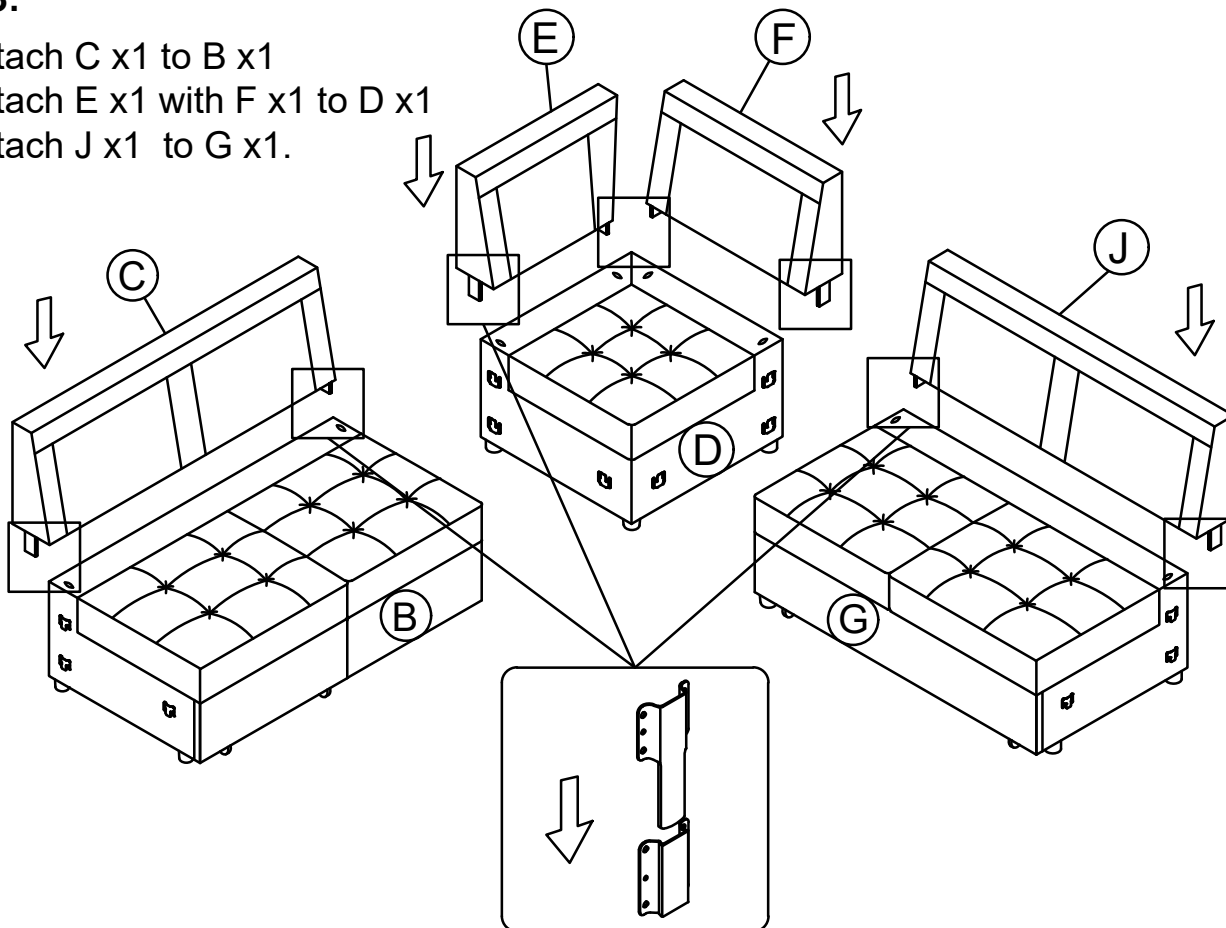

STEP 4:

- 4.1 Attach B x1 to A x1 with D x1
- 4.2 Attach G x1 to H x1 with D x1.

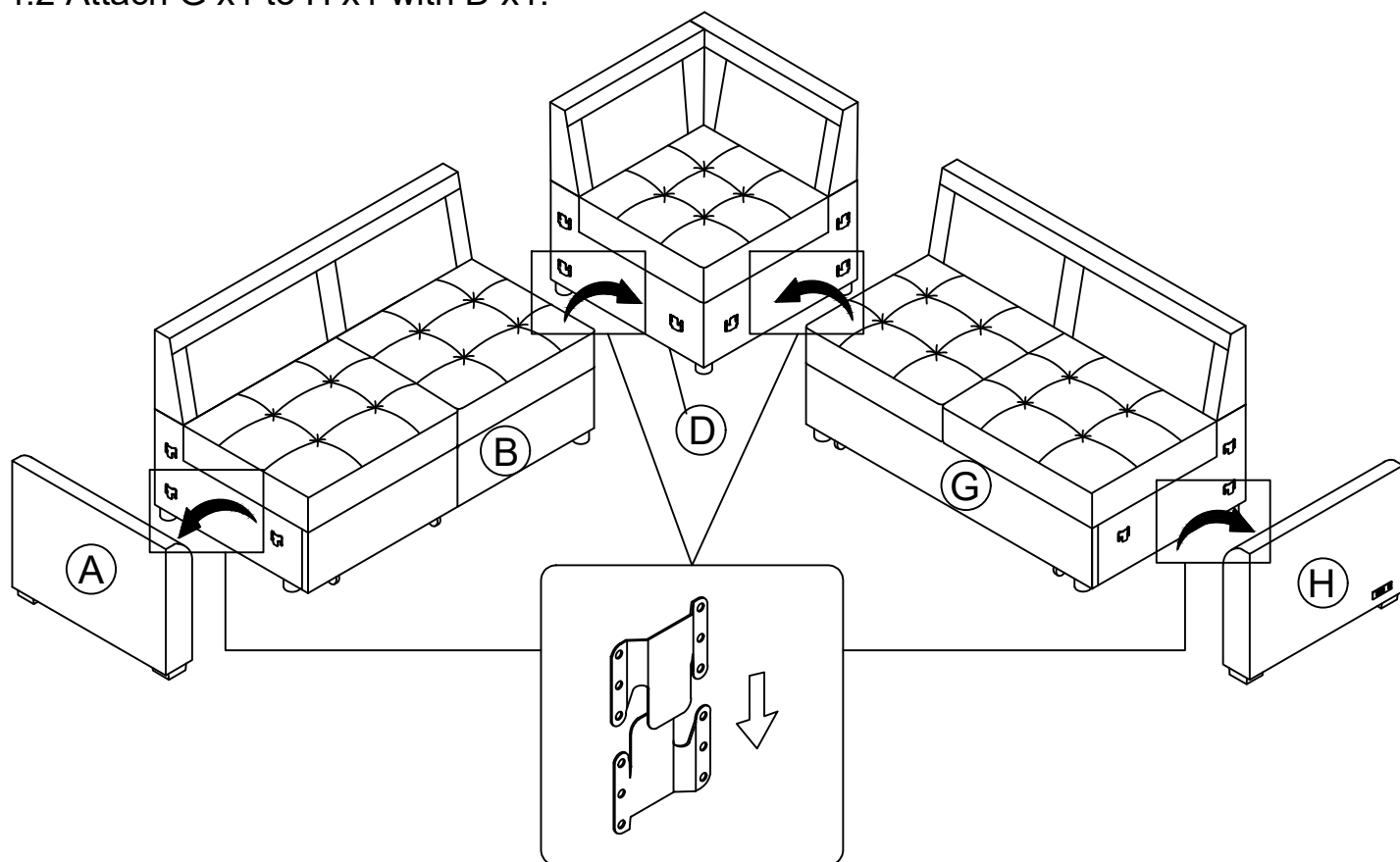

STEP 5:

- 5.1 Attach K x4 to C x1 with J x1
- 5.2 Attach L x1 to E & M with F.

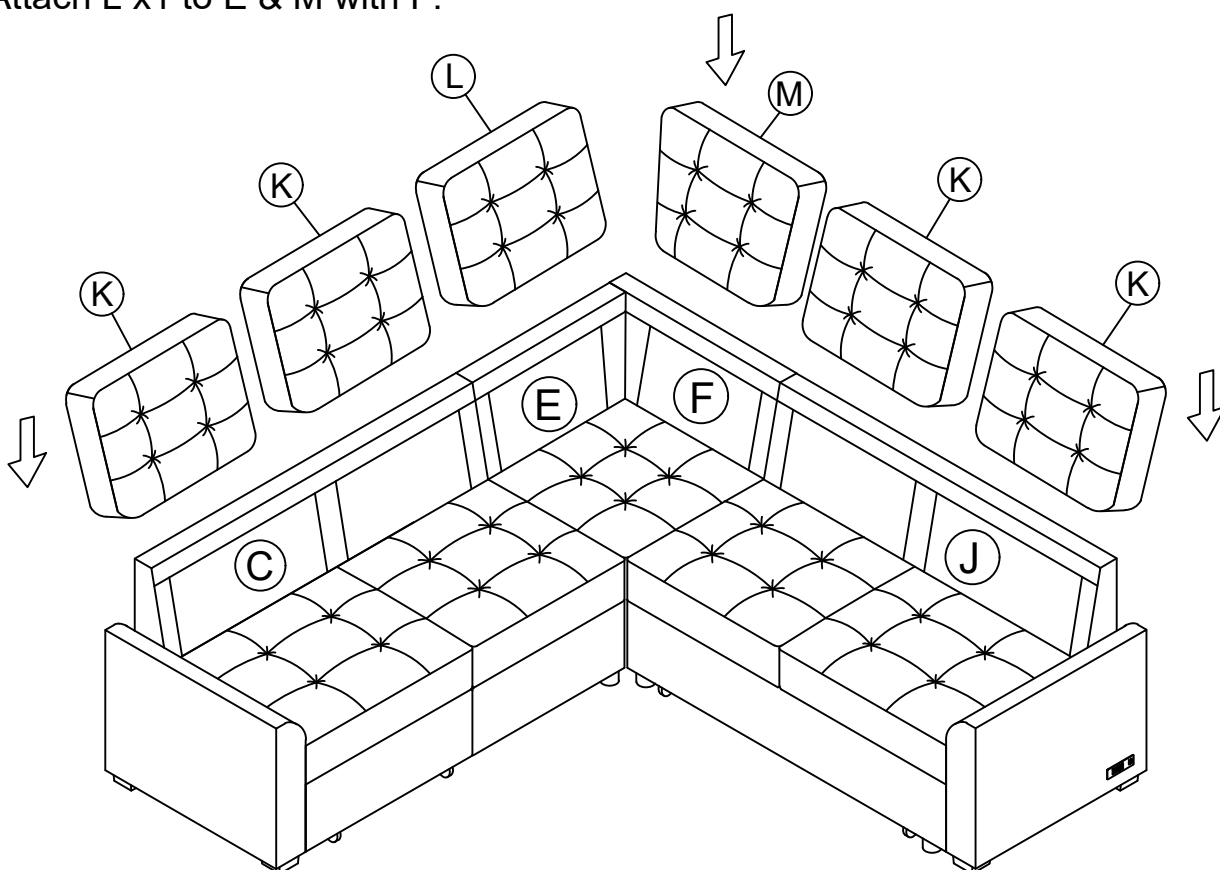

STEP 6:

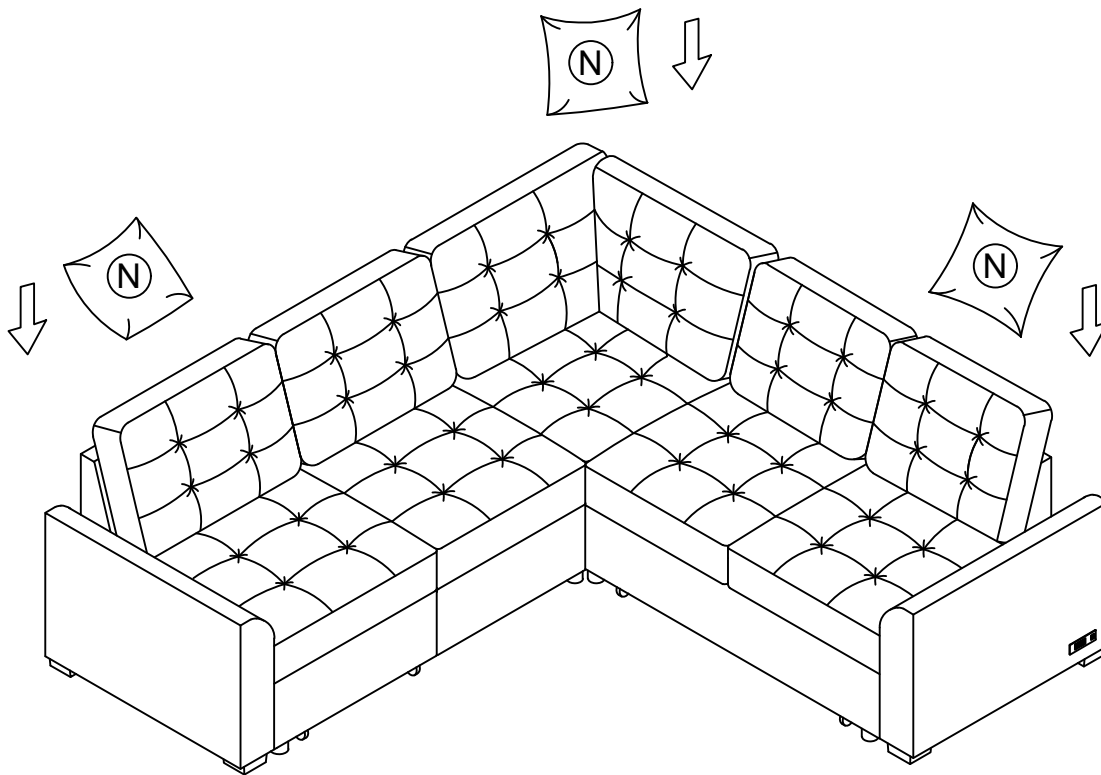

Helpful Hints

- Sectional sofa can transform into a sleeper
- Move your new furniture carefully, with two people lifting and carrying the unit to its new location.
- Your furniture can be disassembled and reassembled to move.
- Clean the product with a soft damp cloth. DO NOT use harsh chemicals or abrasive cleaners.

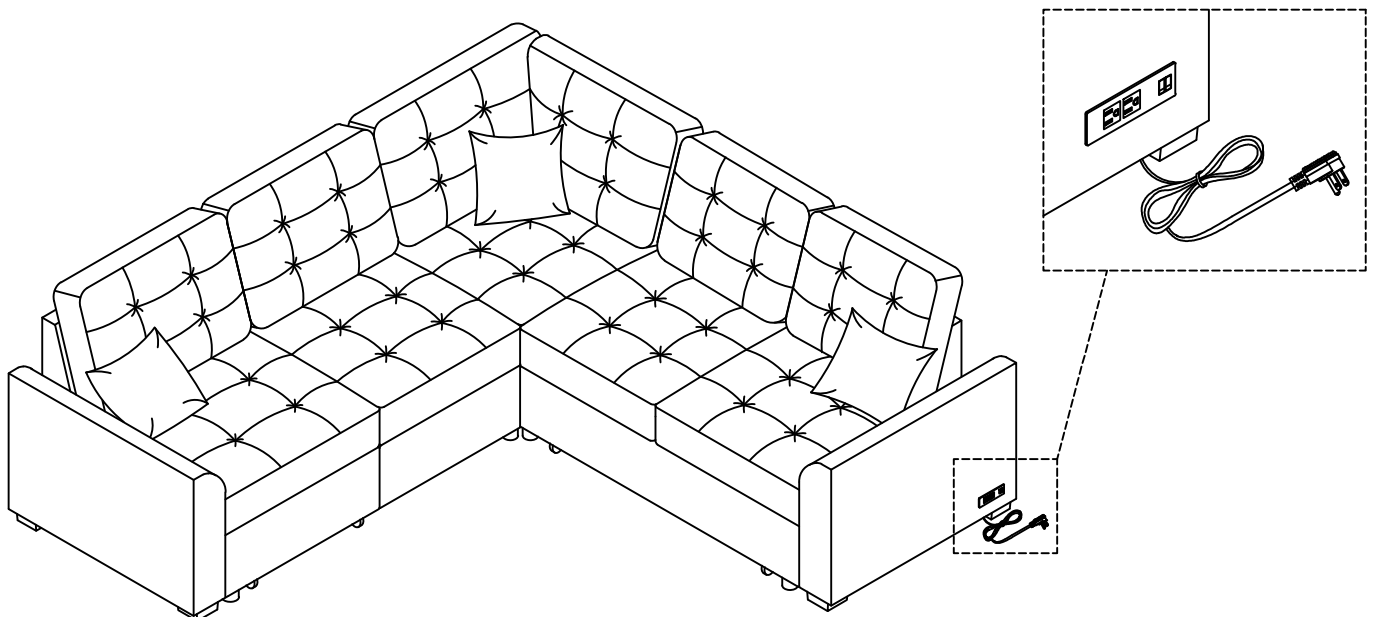

COMPLETE

