

Step 5

Repeat STEPS 2-3 for **BASKET SHELF (B)**. Fit **INLAYS (A)** into bottom of shelves.

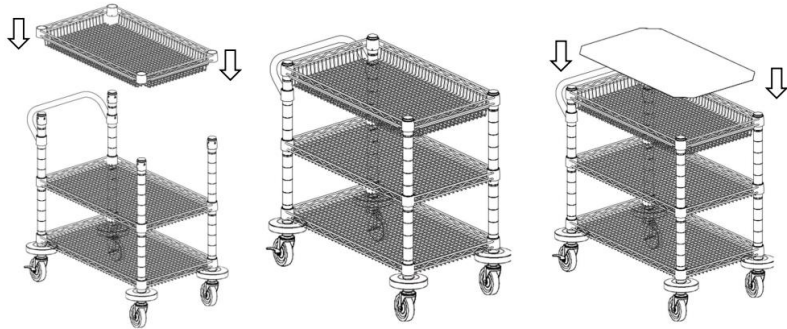

Specifications

Dimensions: 34" W x 18" D x 34.5" H

Net Weight: 31.3 lbs.

Total Weight Capacity Evenly Distributed	500 lbs. (226.8 kg)
---	---------------------

WARNING

- Place heavier items on the lower shelves.
- Do not stand or climb on the utility cart.
- Do not drop heavy items on the utility cart.
- Do not load more than 500 lbs. on the utility cart.

Customer Service Information

Seville Classics, Inc

Telephone: (800) 323-5565

Fax: (310) 533-3899

Hours: 8:30 AM - 4:30 PM (PST), Monday to Friday

Email: Support@sevilleclassics.com

Homepage: www.sevilleclassics.com

seville classics®

Commercial-Grade NSF Utility Cart

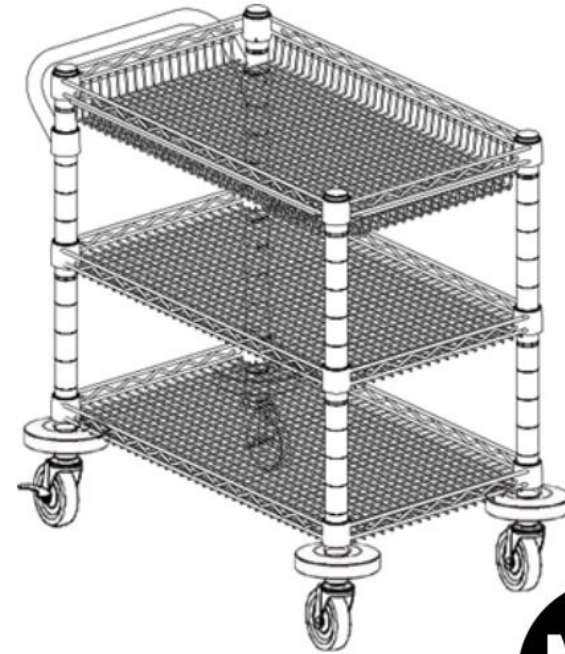

Model No.: SHE99309VB & SHE99308B

Thank you for choosing Seville Classics®! We hope that you enjoy your new Commercial Utility Cart. Please read through this user guide for parts list, assembly instructions, frequently asked questions, and further contact information.





RC032224

PARTS LIST

Please make sure you have all the parts on this list.

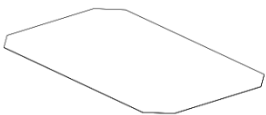
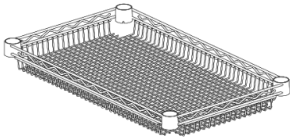
If you're missing parts, contact us for replacements at

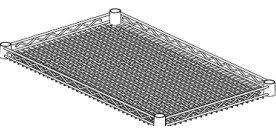
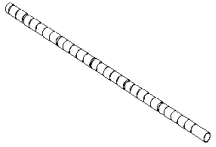
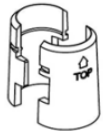
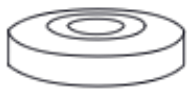
(800) 323-5565 or send an email to Support@sevilleclassics.com

A. Inlay (3)	B. Basket shelf (1)	C. Handle (1)
		
D. Shelves (2)	E. Poles (4)	F. Slip sleeves (12)
		
G. Bumpers (4)	H. Locking wheels (2)	I. Wheels (2)
		

Step 1

Fit **BUMPER (G)** over bottom of **POLE (E)**. Press stem of **WHEELS (H, I)** into bottom of **POLE (E)**. Wheels should "click" when installed. Repeat for all **POLES (E)**.

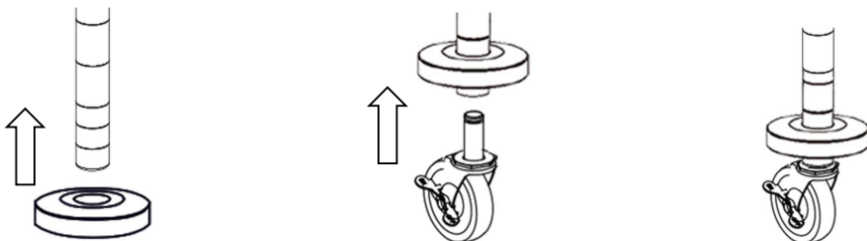

1

Step 2

Snap **SLIP SLEEVES (F)** to the lowest groove on **POLES (E)**.

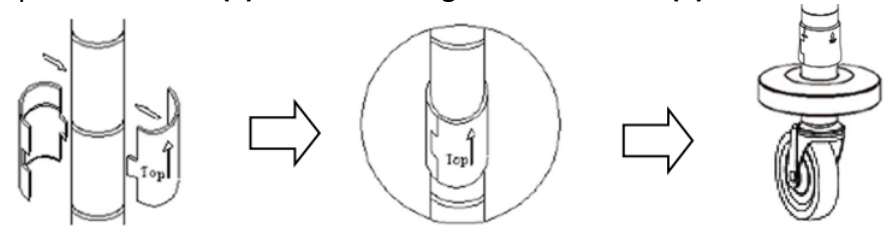

Step 3

Fit **SHELF (D)** over the top of the 4 poles and over **SLIP SLEEVES (F)**. Poles with locking wheels should be on same narrow side. Repeat **STEPS 2-3** at desired height for 2nd shelf.

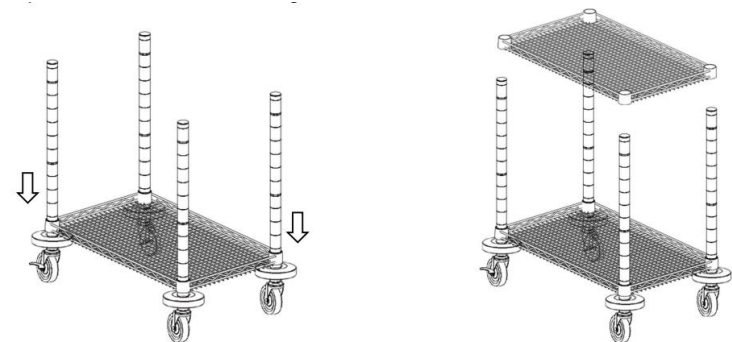

Step 4

Snap 2 **SLIP SLEEVES (F)** to poles on the narrow side of the cart. Leave space at top of **POLES (E)** for final shelf. Slide **HANDLE (C)** over **SLIP SLEEVES (F)**.

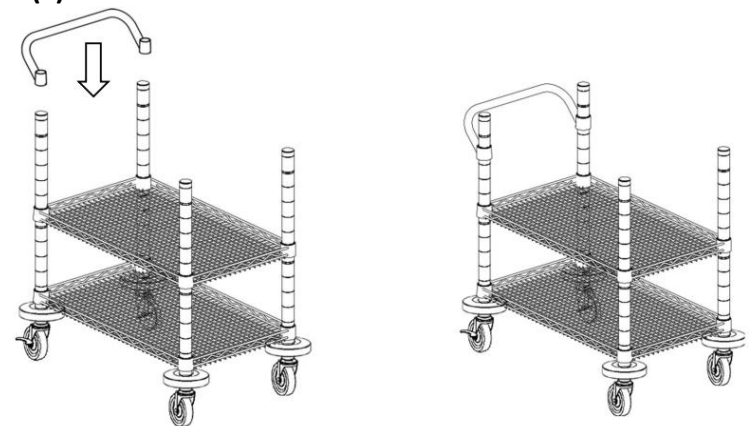

2