

ASSEMBLY INSTRUCTION

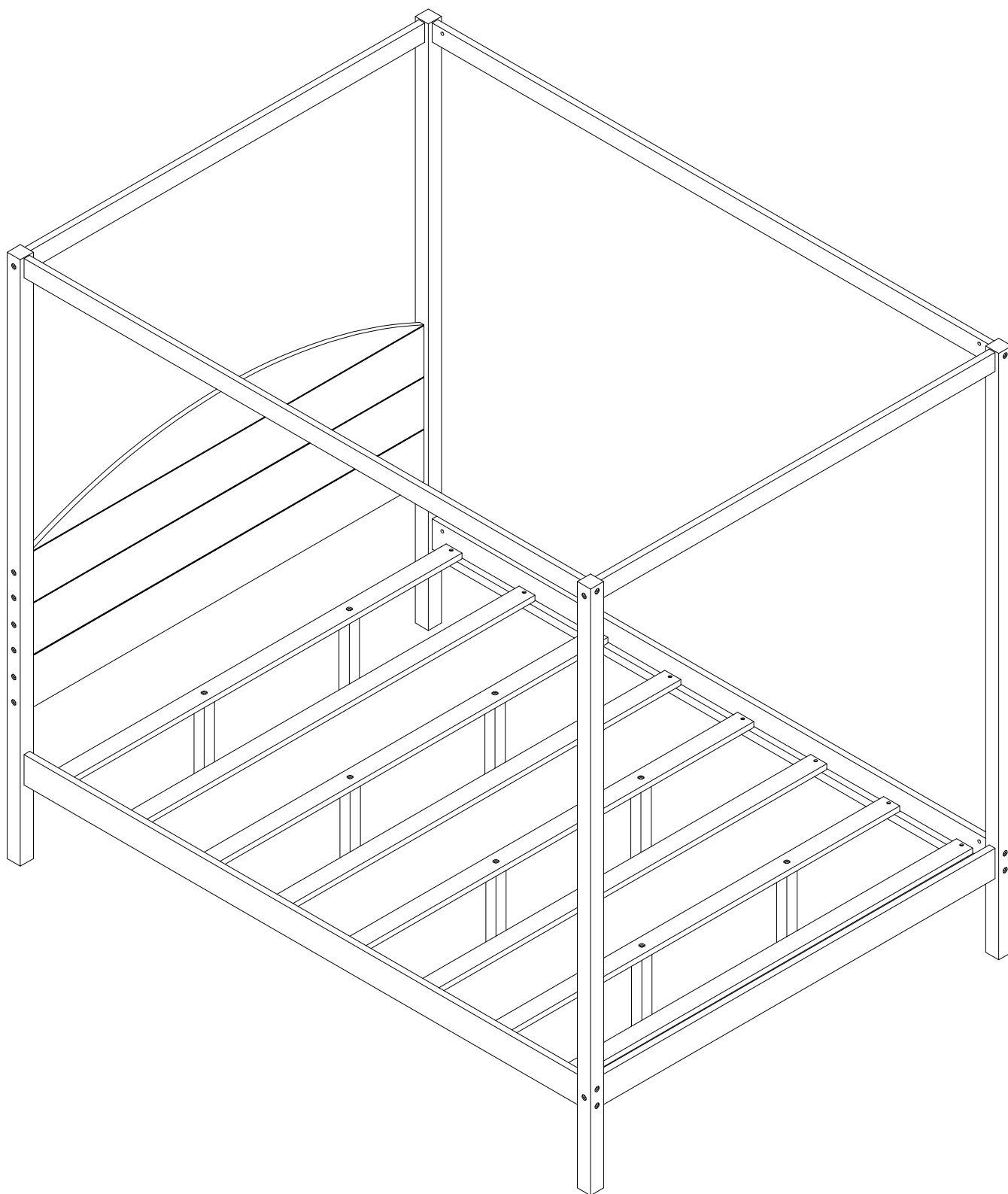

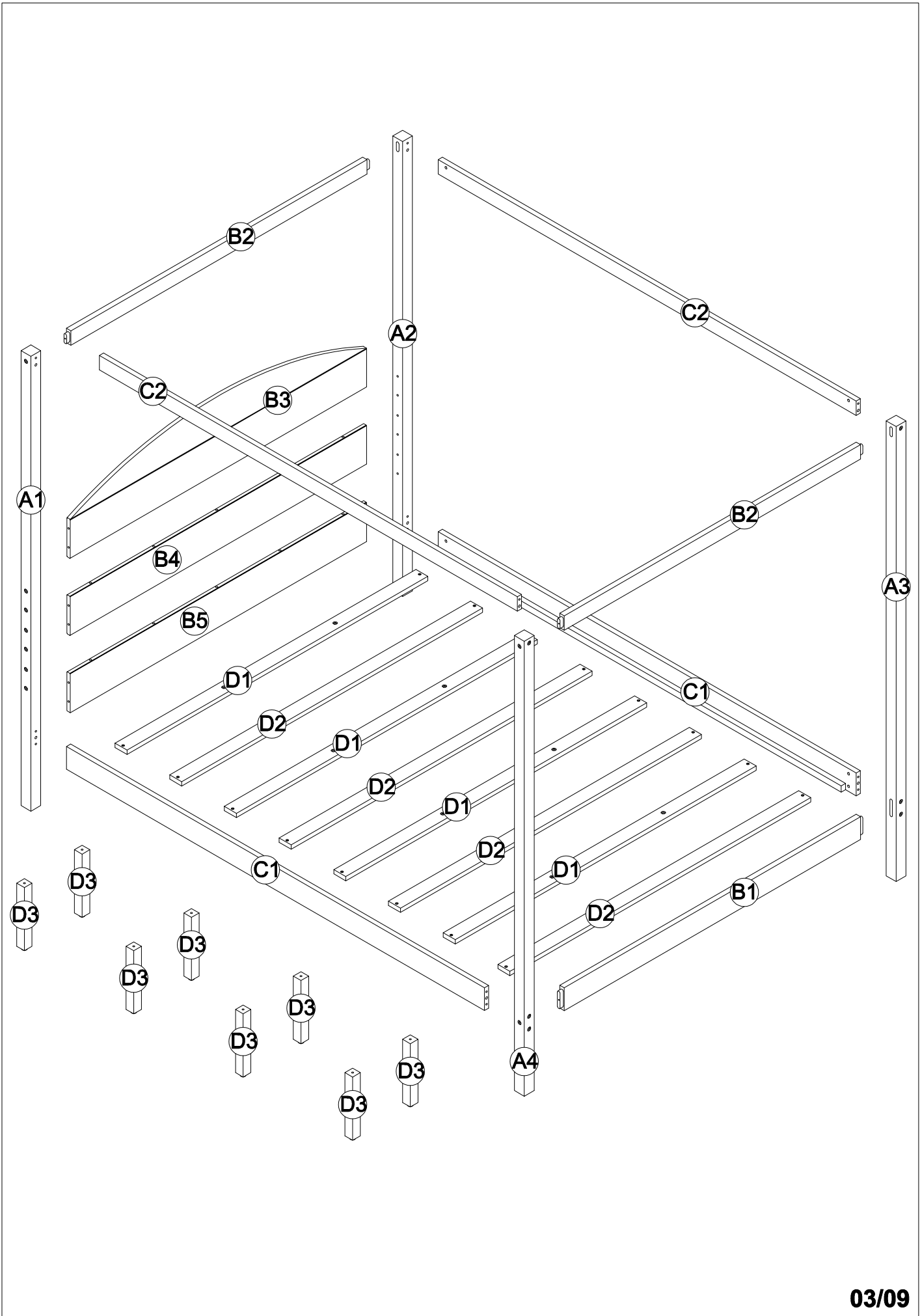







SAFETY WARNINGS AND GENERAL NOTES:



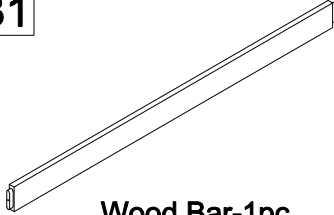

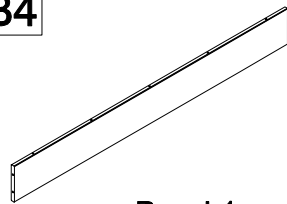
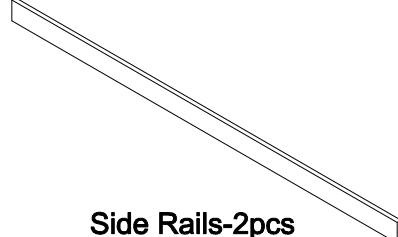
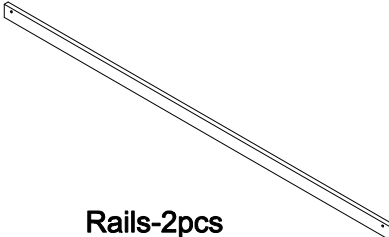
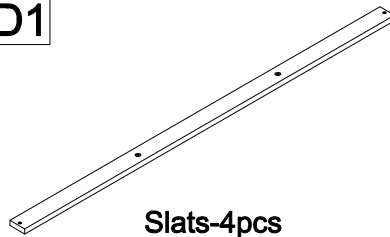
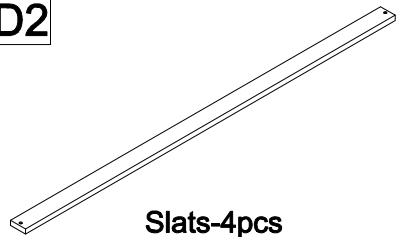

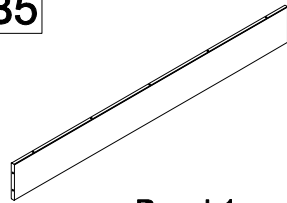
1. Do not use substitute parts. Contact the manufacturer or dealer for replacement parts.
2. Keep these instructions for future reference.
3. We recommend assembling your bed on the shipping carton to protect your floor or carpet.
4. Be certain all staples are out of the box before beginning assembly on the shipping carton.

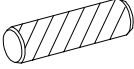

Part List & Hardware List

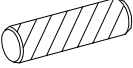
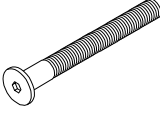
<p>A1</p>  <p>Leg(Front-Left)-1pc</p>	<p>A2</p>  <p>Leg(Back-Left)-1pc</p>	<p>A3</p>  <p>Leg(Back-Right)-1pc</p>
<p>A4</p>  <p>Leg(Front-Right)-1pc</p>	<p>B1</p>  <p>Wood Bar-1pc</p>	<p>B2</p>  <p>Wood Bars-2pcs</p>
<p>B3</p>  <p>Panel-1pc</p>	<p>B4</p>  <p>Panel-1pc</p>	<p>C1</p>  <p>Side Rails-2pcs</p>
<p>C2</p>  <p>Rails-2pcs</p>	<p>D1</p>  <p>Slats-4pcs</p>	<p>D2</p>  <p>Slats-4pcs</p>
<p>D3</p>  <p>Support Slats-8pcs</p>	<p>B5</p>  <p>Panel-1pc</p>	

Hardware List

1  Screws 1/4" x70 6pcs	2  Ø8 x 30 mm Wood dowel 10pcs	3  Ø1/4" x 60 mm Hex-Head bolts 12pcs
4  Ø10 x 40 mm Wood dowel 8pcs	5  Ø1/4" x 90 mm Hex-Head bolts 12pcs	6  Ø1/4" x 13 mm Horizontal-Hole bolts 12pcs
7  Ø1/4" x 30 mm Hex-Head bolts 8pcs	8  M4 x 30 mm Wood Screws 16pcs	9  Allen Key 1pc

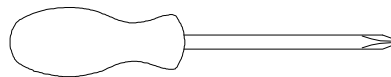

Assembly Tools Required (Not Included)

STEP1: Following below illustration Assembly Headboard .

-Using Dowel #2 Fix B4(x2) With B3 Panels

-Using hardware #1,#3 connect A1,A2 Legs With B3,B4,B5 Panels and B2 Wood Bar

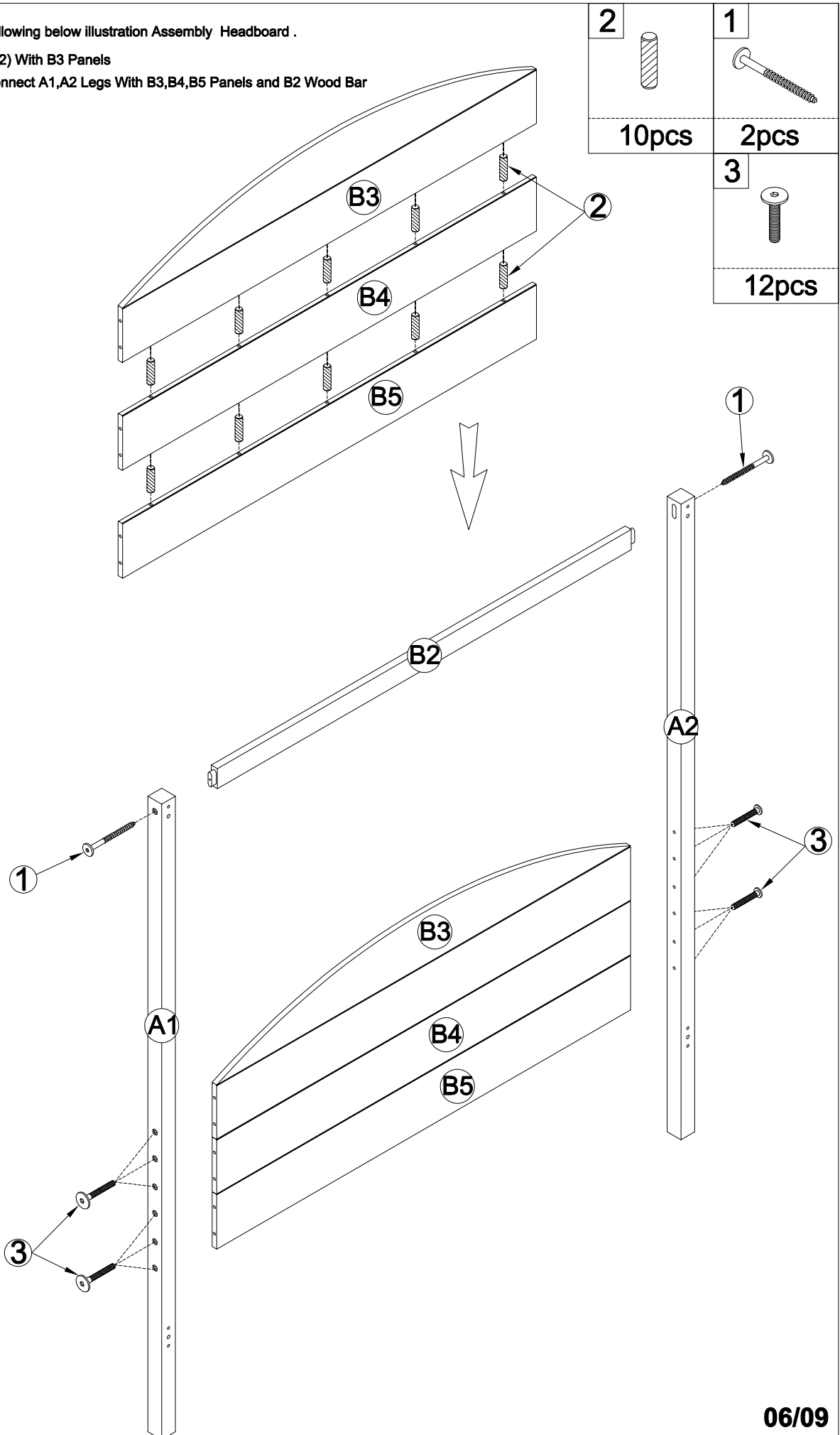

STEP 1: Following below illustration Assembly Footboard .

-Using hardware #1 connect A3,A4 Legs With B1,B2 Wood Bars

1



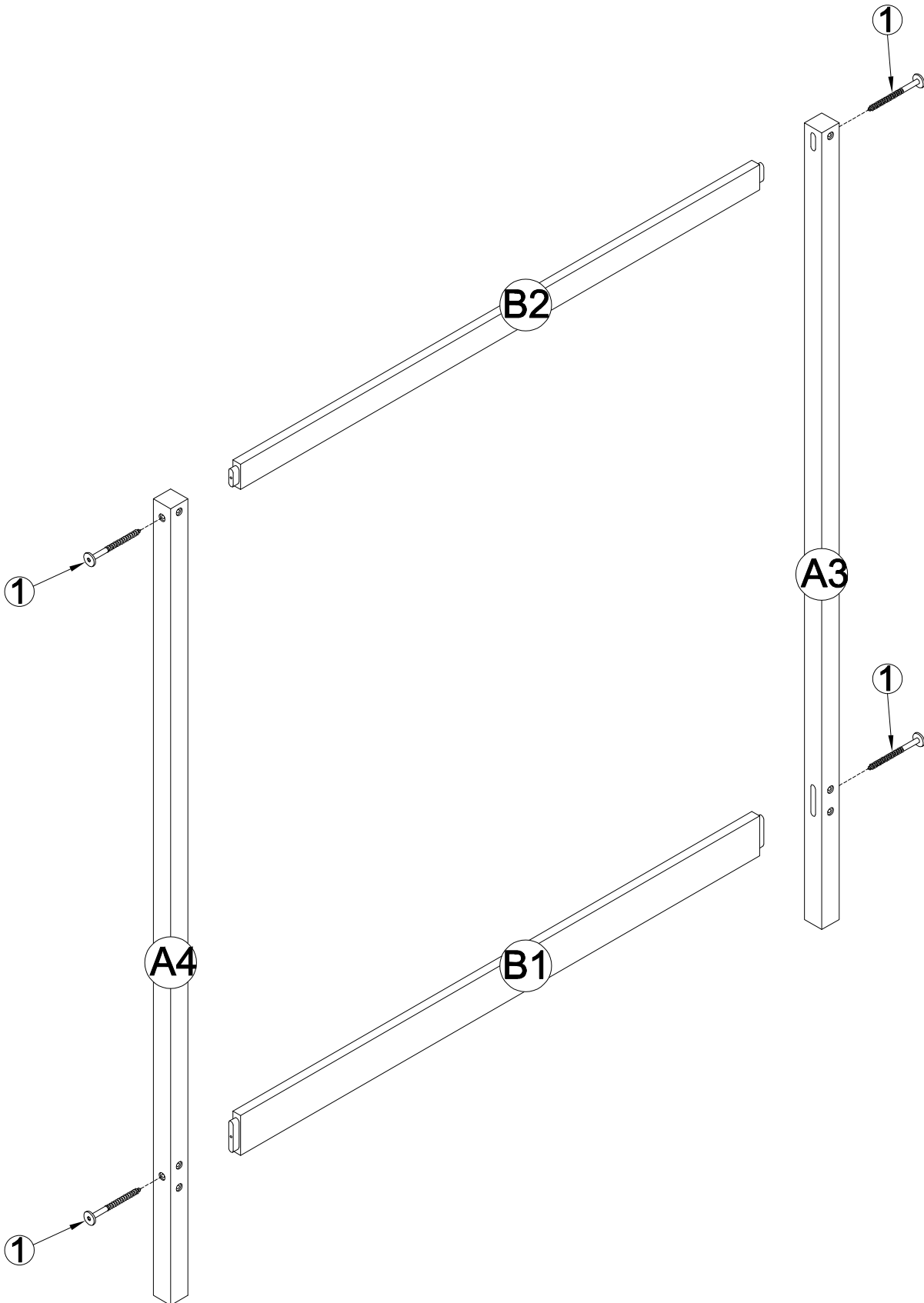

4pcs



STEP 3: Following below illustration:

-Using hardware #5, #6 and dowel #4 to Assembly Headboard and Footboard with siderail C1(x2) and Rails C2(x2)

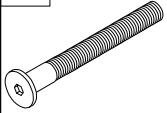
-Look at detail view for more detail

6	5	4
		
12pcs	12pcs	8pcs

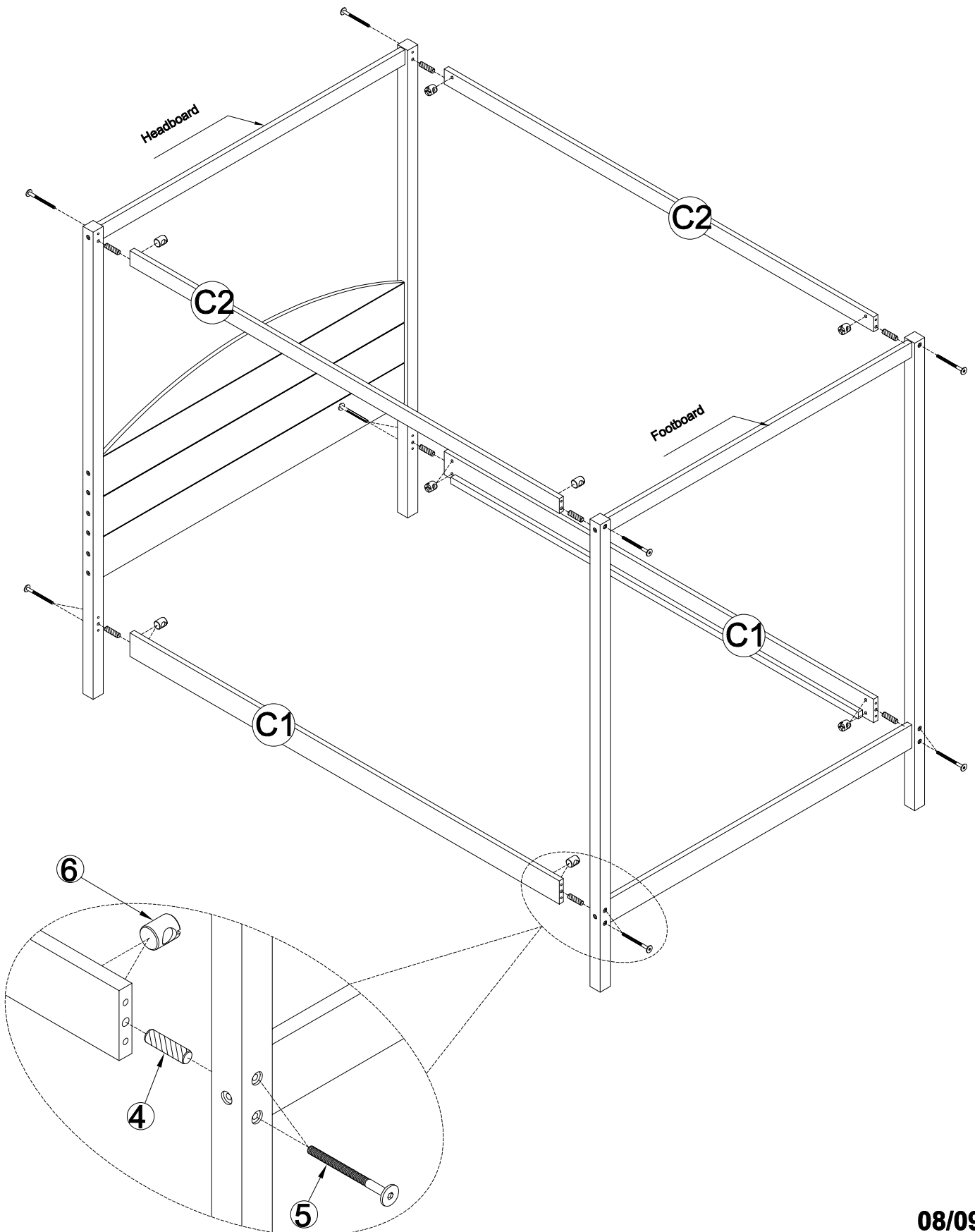



STEP 4: Following below illustration:

-Using hardware #7 to Assembly Slats D1(x4) With Support Slats D3(x4)

-Screw slats D1(x4),D2(x4) with Side Rail C1 by using hardware #8.

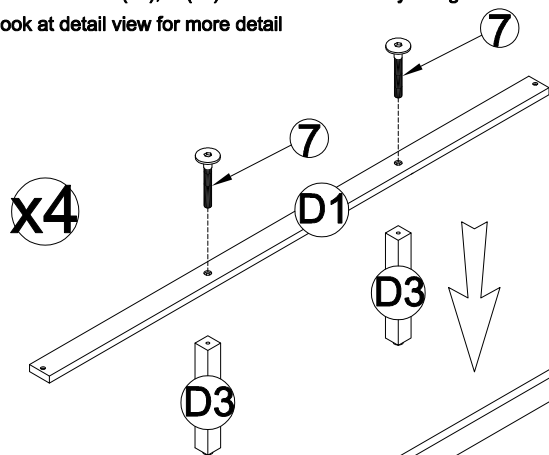
-Look at detail view for more detail

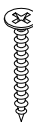

7	
8pcs	
8	
16pcs	

