

User Manual

(Manual del Usuario)

Nyeekoy



Model Number: THP0383
(Número del Modelo)

Nyeekoy

You need (Usted Necesita)

















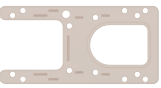



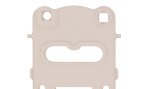

① 1 person needed
(Se necesita 1 persona)



The product colors in the manual are for reference only, subject to the actual product.

(Los colores del producto en el manual son solo de referencia y están sujetos al producto real.)

Hardware List (Lista de Accesorios)

			
① 3PCS (Piezas)	② 1SET (Juego)	③ 1PC (Pieza)	④ 1PC (Pieza)
			
⑤ 1SET (Juego)	⑥ 1SET (Juego)	⑦ 1PC (Pieza)	⑧ 3PCS (Piezas)
			
⑨ 2PCS (Piezas)	⑩ 1PC (Pieza)	⑪ 1PC (Pieza)	⑫ 1PC (Pieza)
			
⑬ 2PCS (Piezas)	⑭ 3PCS (Piezas)	⑮ 4PCS (Piezas)	⑯ 1PC (Pieza)
			
⑰ 1PC (Pieza)	⑱ 1PC (Pieza)		
			
A 7PCS (Piezas)	B 2PCS (Piezas)	C 14PCS (Piezas)	D 52PCS (Piezas)
			
E 2PCS (Piezas)			

PRODUCT ASSEMBLY (Ensamblaje del Producto)

⚠ Check the package contents before getting started !
 (¡Revise el contenido del paquete antes de comenzar!)

STEP 1/ Paso 1

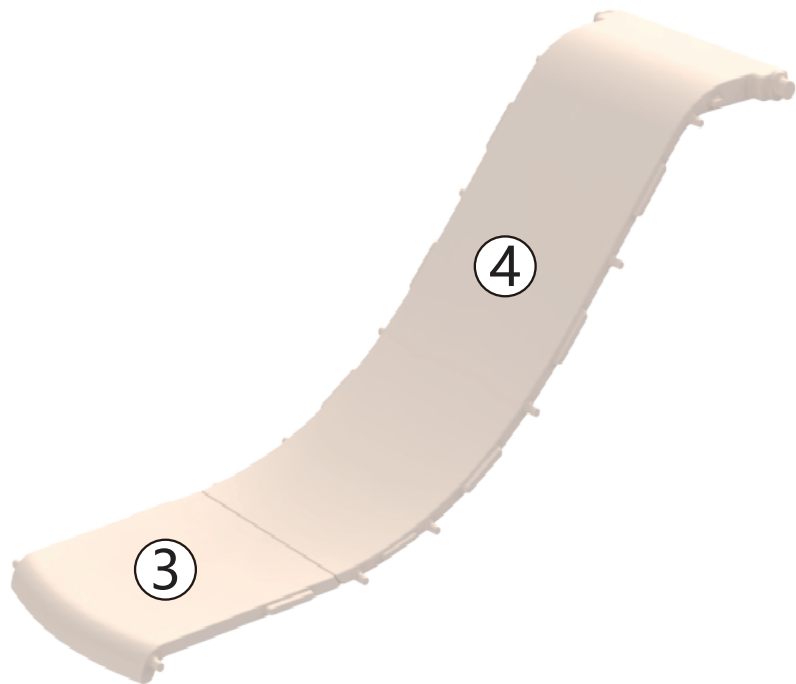
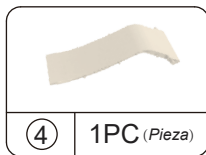
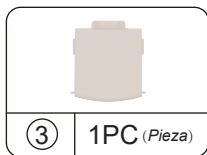

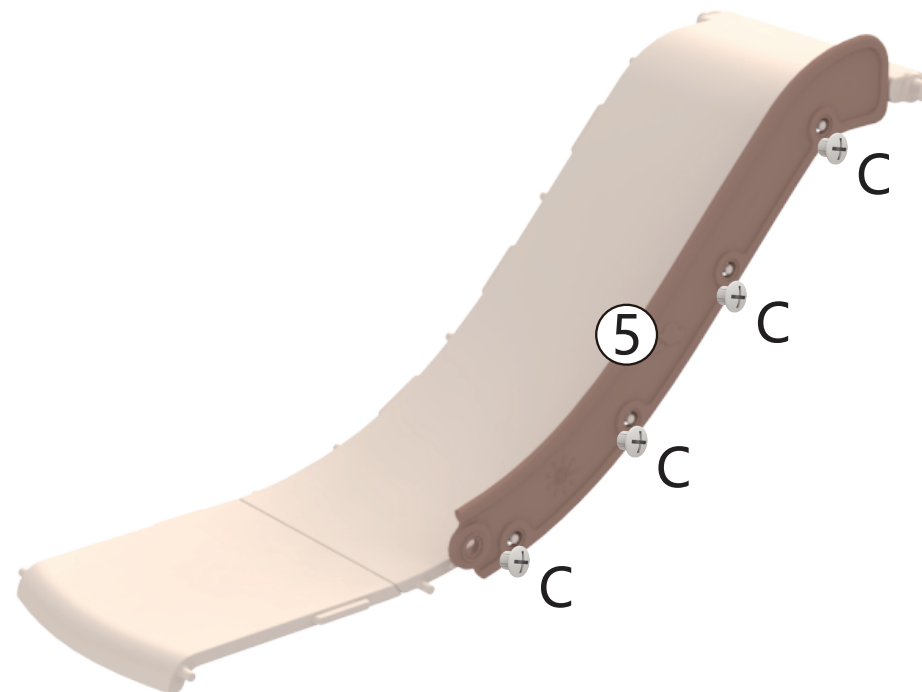
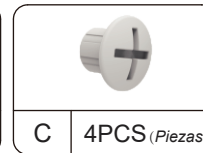
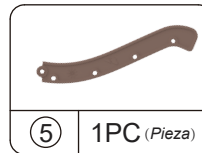

PRODUCT ASSEMBLY (Ensamblaje del Producto)

STEP 2/ Paso 2



PRODUCT ASSEMBLY (Ensamblaje del Producto)

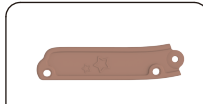

STEP 3/ Paso 3

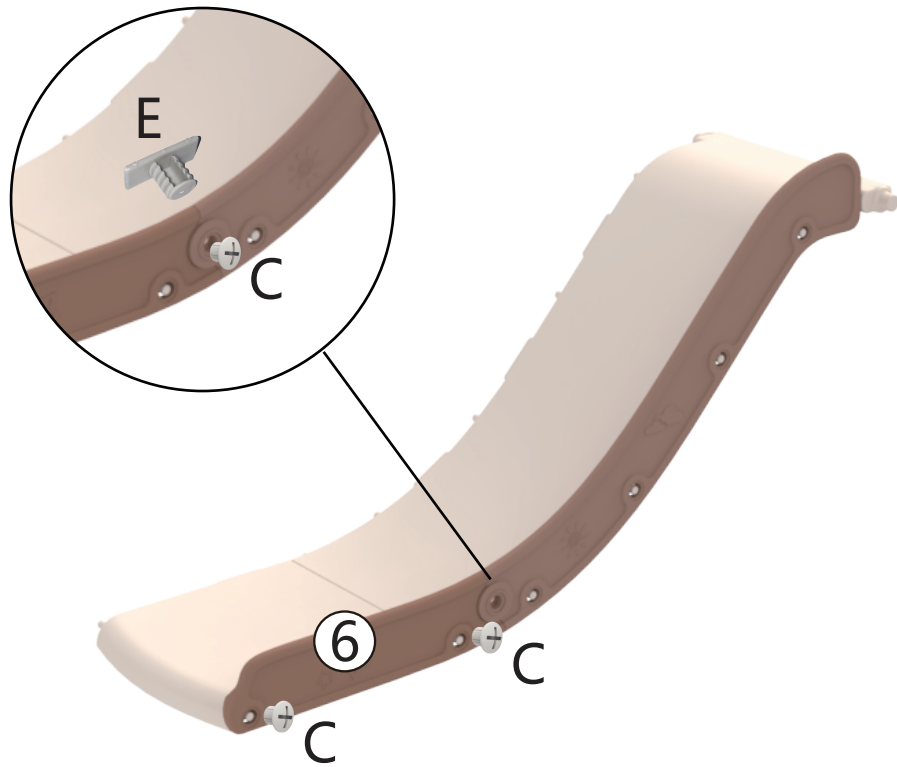
		
⑥ 1PC (Pieza)	C 3PCS (Piezas)	E 1PC (Pieza)



PRODUCT ASSEMBLY (Ensamblaje del Producto)

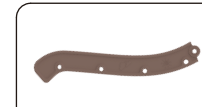
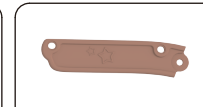

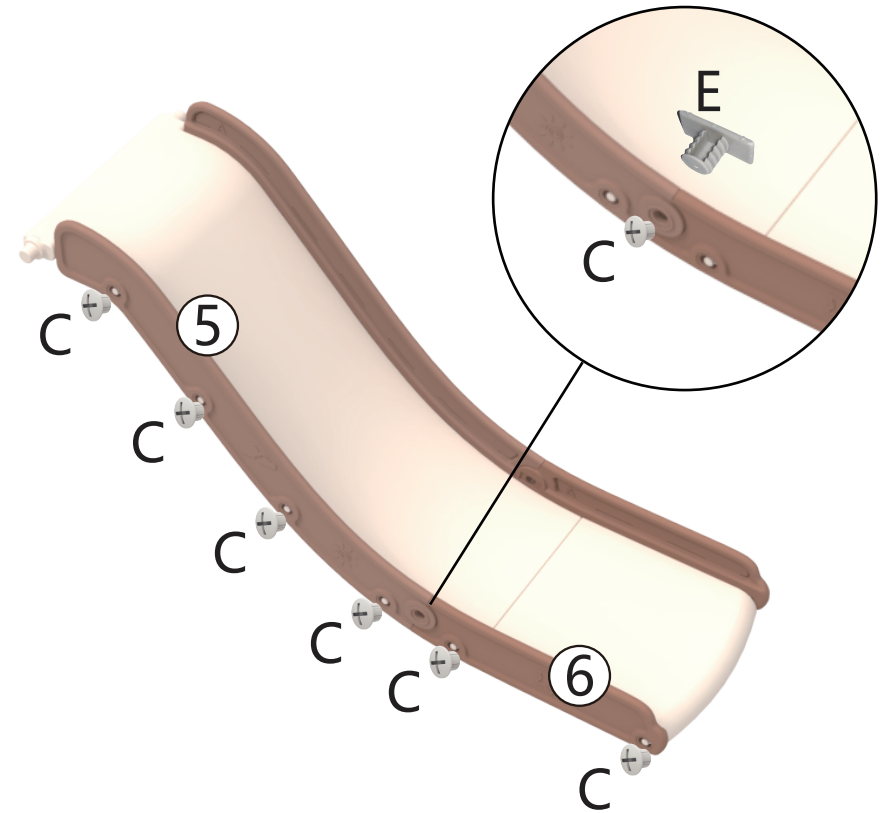

STEP 4/ Paso 4

			
⑤ 1PC (Pieza)	⑥ 1PC (Pieza)	C 7PCS (Piezas)	E 1PC (Pieza)



PRODUCT ASSEMBLY (Ensamblaje del Producto)

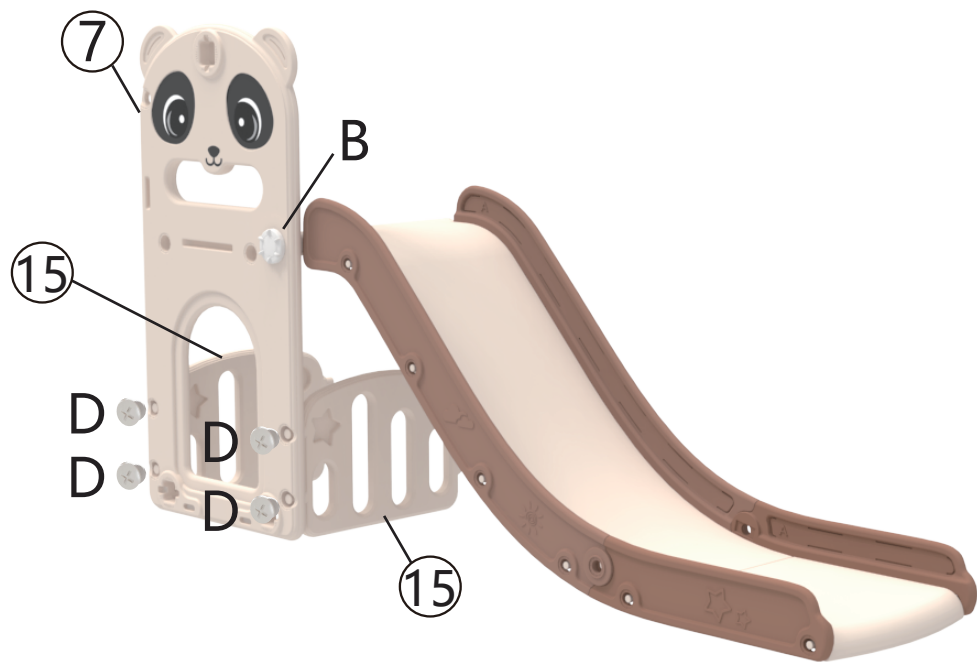

STEP 5/ Paso 5

			
⑦ 1PC (Pieza)	⑮ 2PCS (Piezas)	B 1PC (Pieza)	D 4PCS (Piezas)

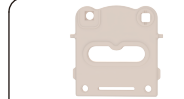

PRODUCT ASSEMBLY (Ensamblaje del Producto)

STEP 6/ Paso 6

		
⑩ 1PC (Pieza)	⑭ 1PC (Pieza)	D 2PCS (Piezas)

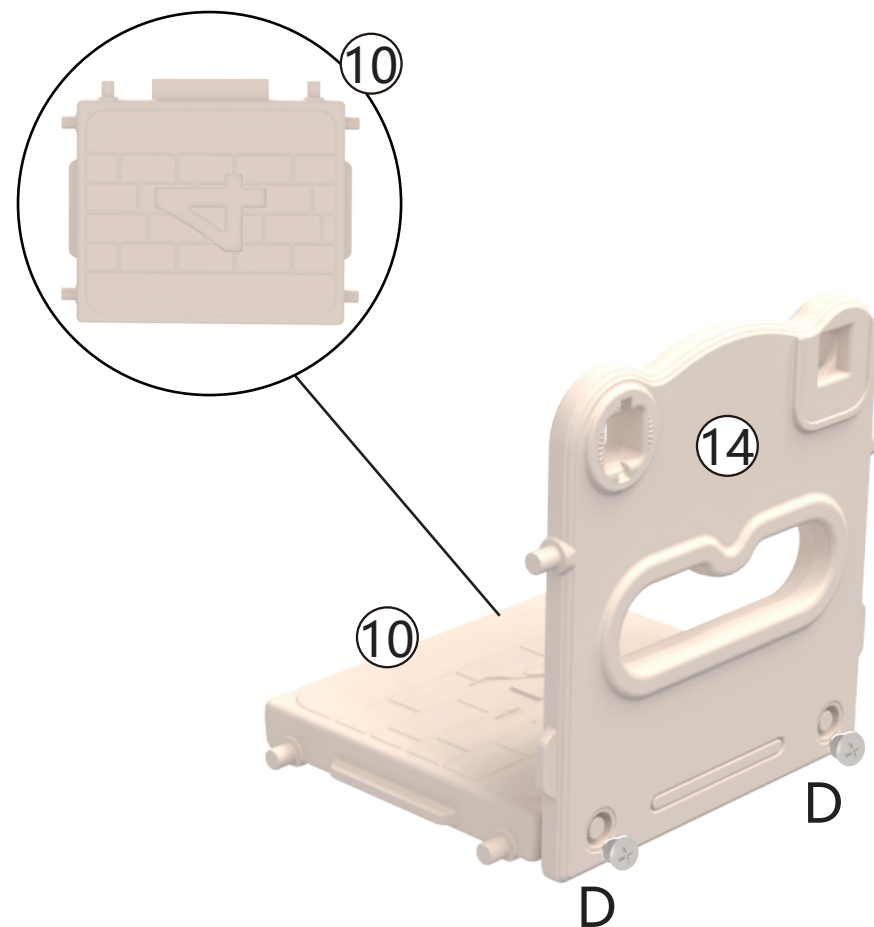

STEP 7/ Paso 7

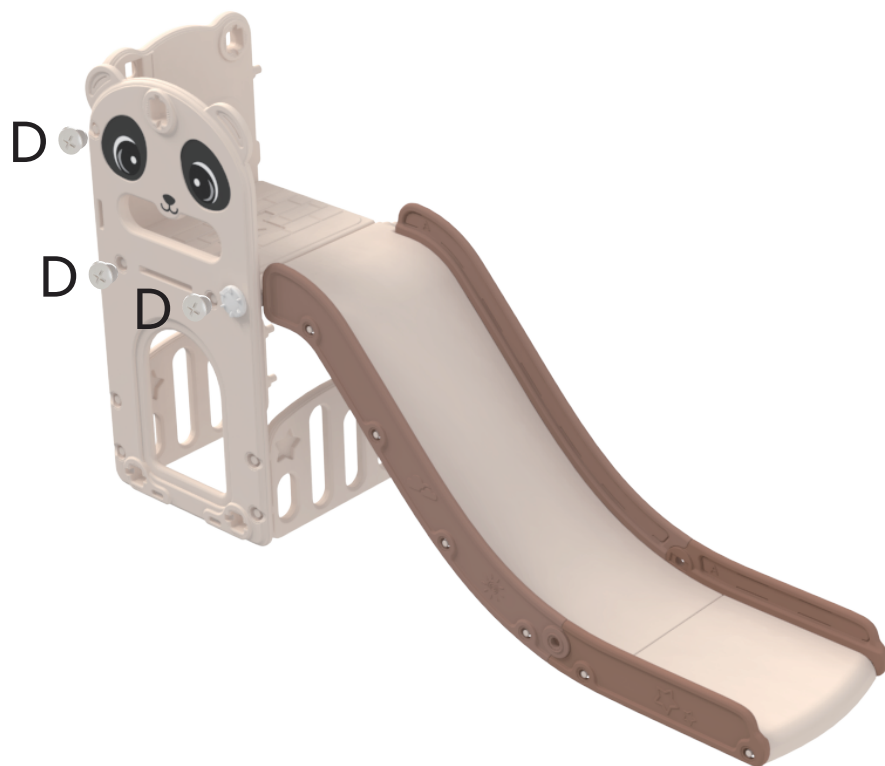

STEP 8/ Paso 8

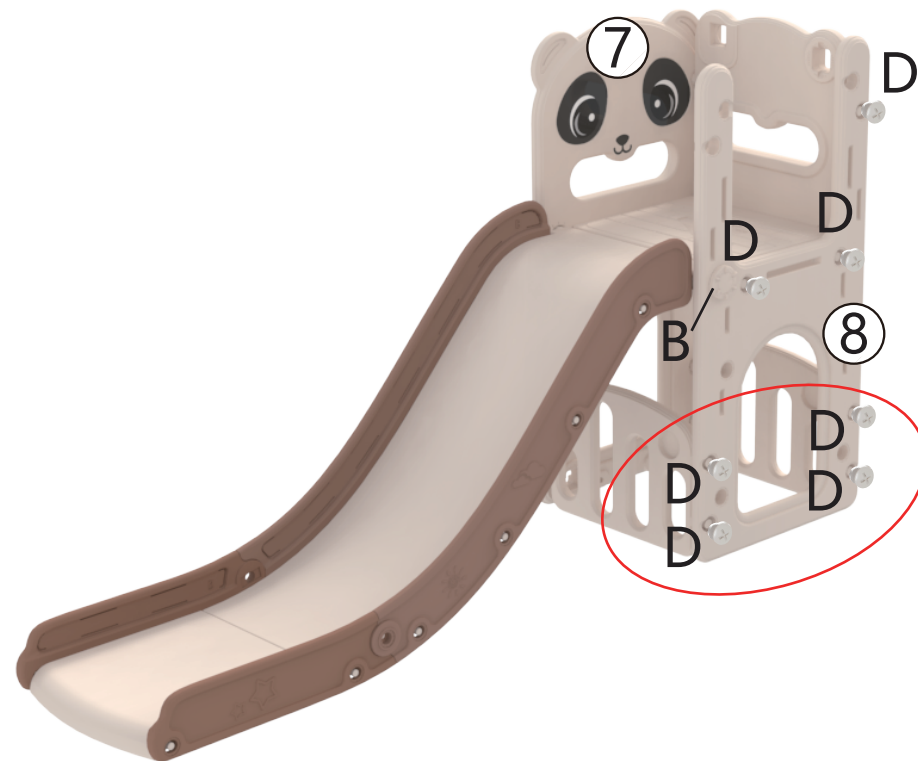
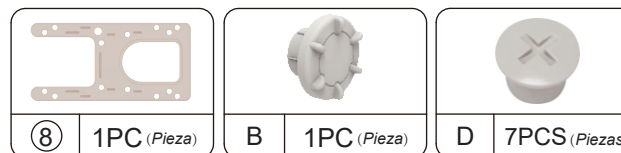

Please do not over-tighten the 4 D screws.
 (Por favor, no atorque demasiado los 4 tornillos D.)

PRODUCT ASSEMBLY (Ensamblaje del Producto)

STEP 9/ Paso 9

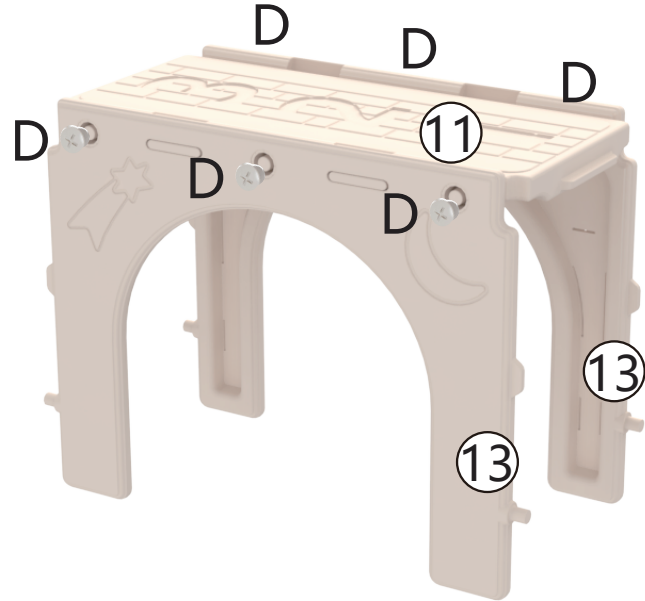
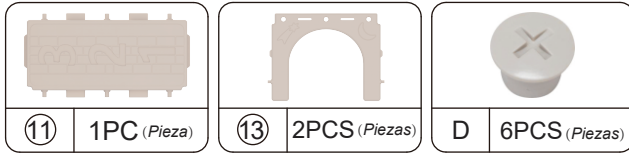

PRODUCT ASSEMBLY (Ensamblaje del Producto)

STEP 10/ Paso 10

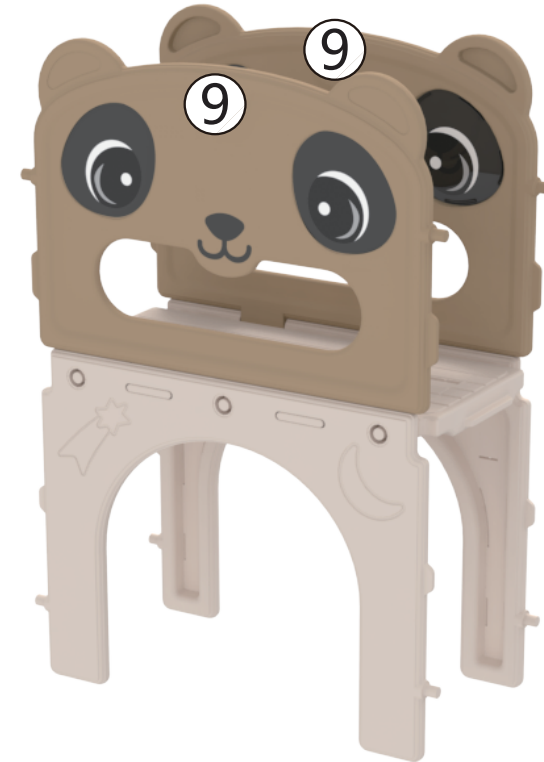
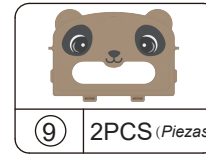

STEP 11/ Paso 11

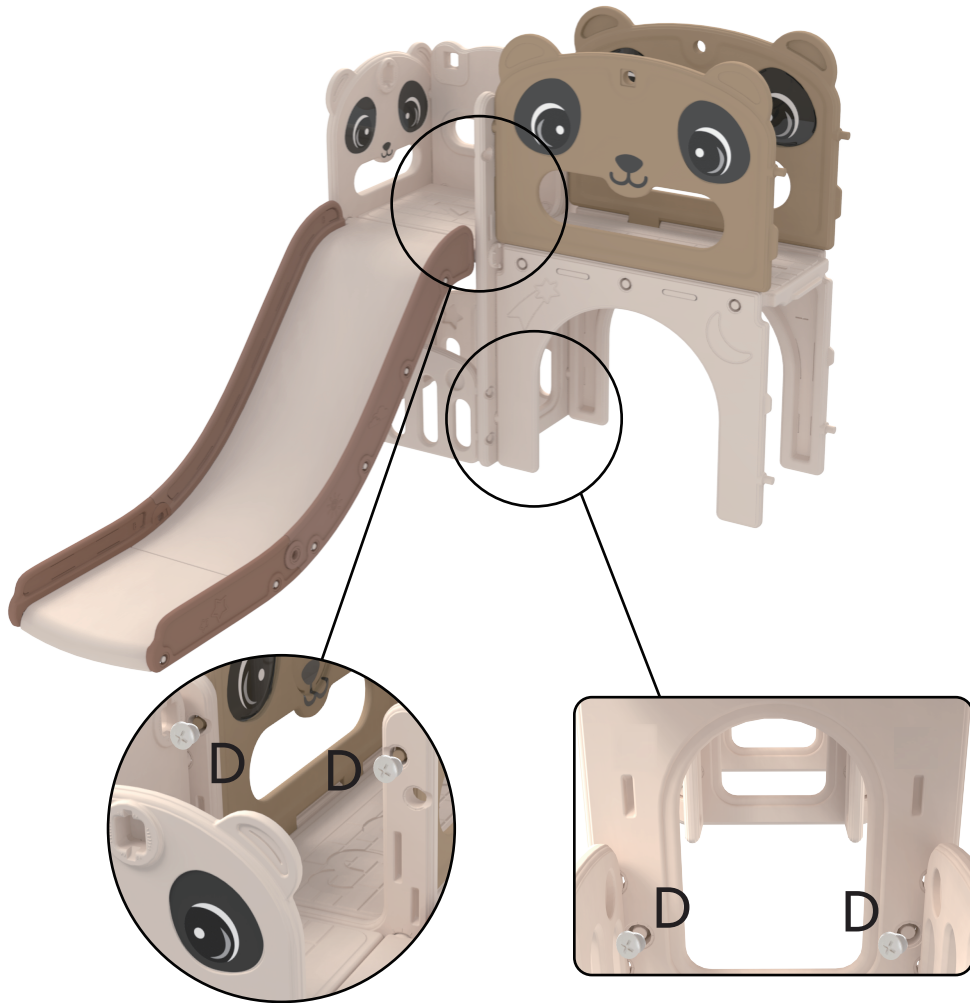
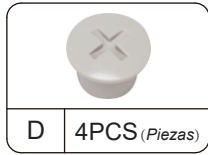

STEP 12/ Paso 12

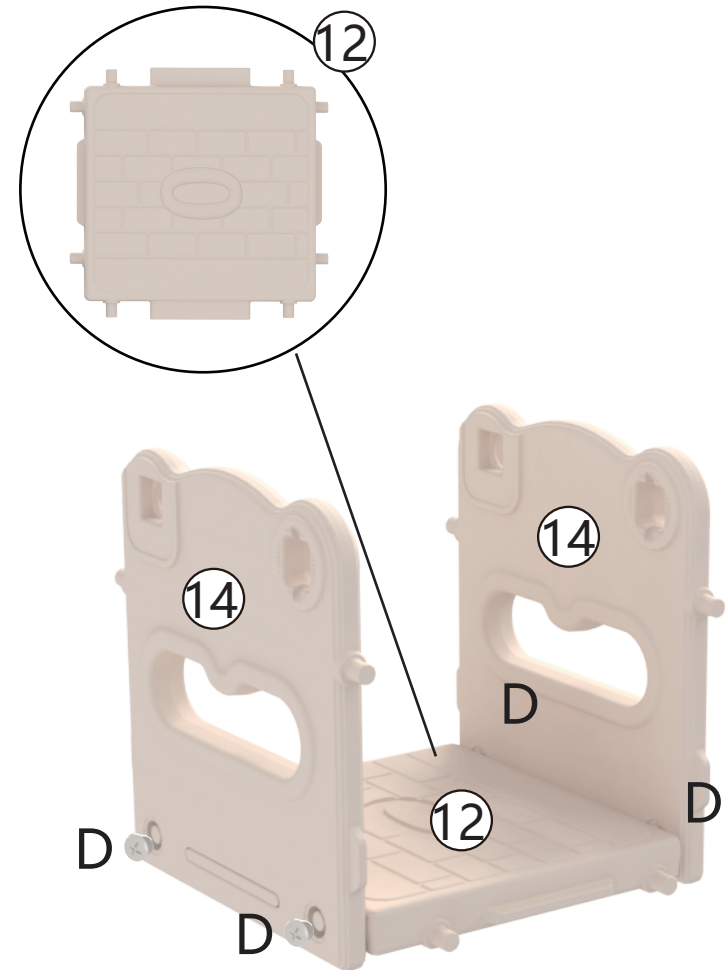
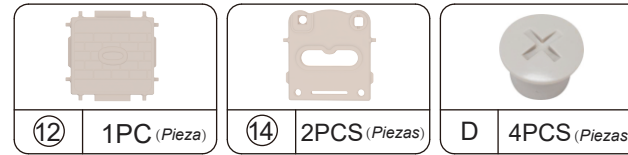

STEP 13/ Paso 13

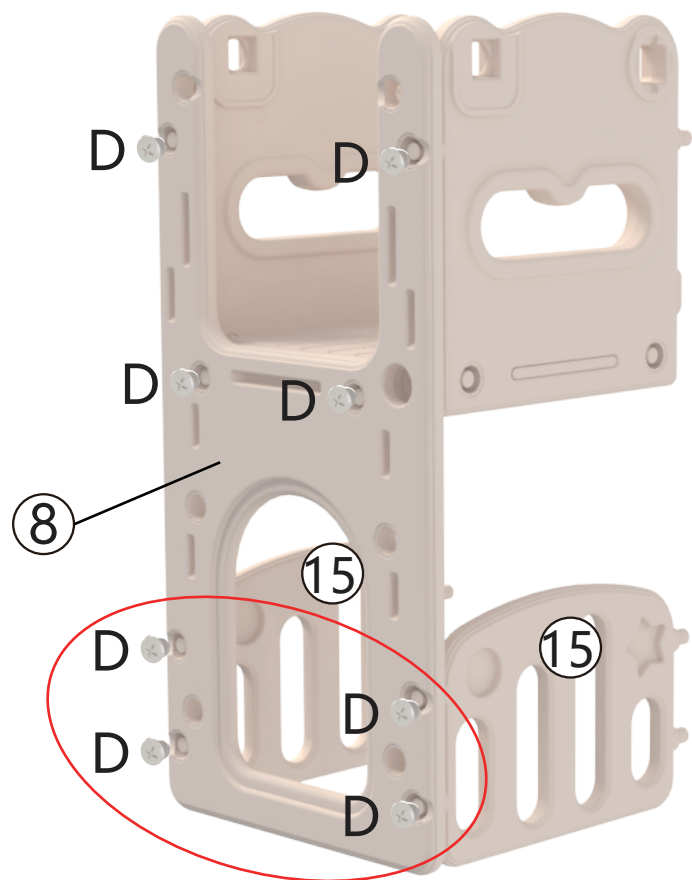
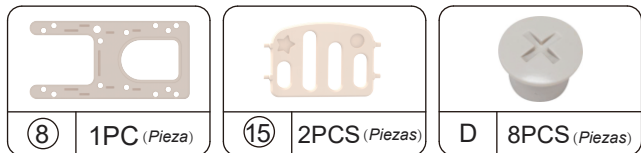

Please do not over-tighten the 4 D screws.
 (Por favor, no atorque demasiado los 4 tornillos D.)

STEP 14/ Paso 14

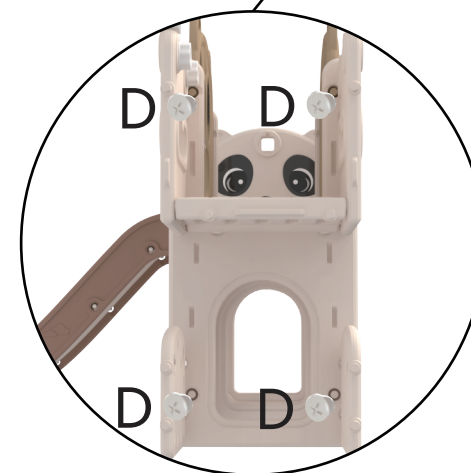
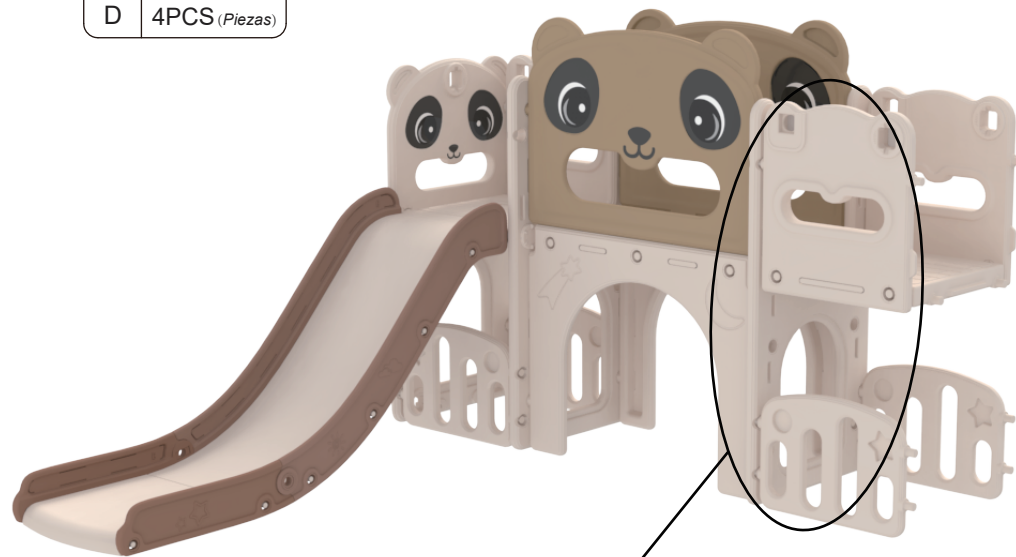
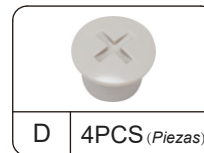

PRODUCT ASSEMBLY (Ensamblaje del Producto)

STEP 15/ Paso 15

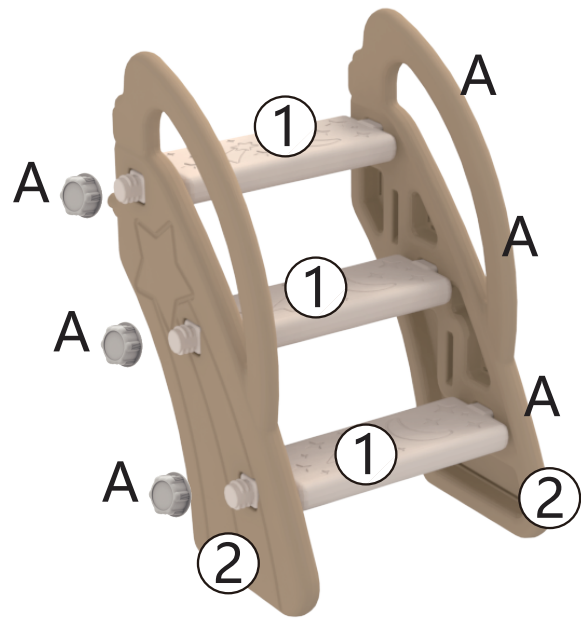
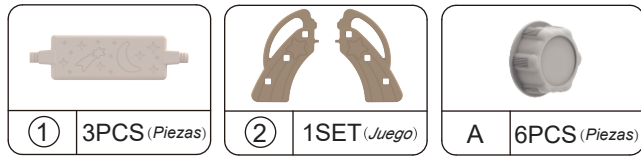

PRODUCT ASSEMBLY (Ensamblaje del Producto)

STEP 16/ Paso 16

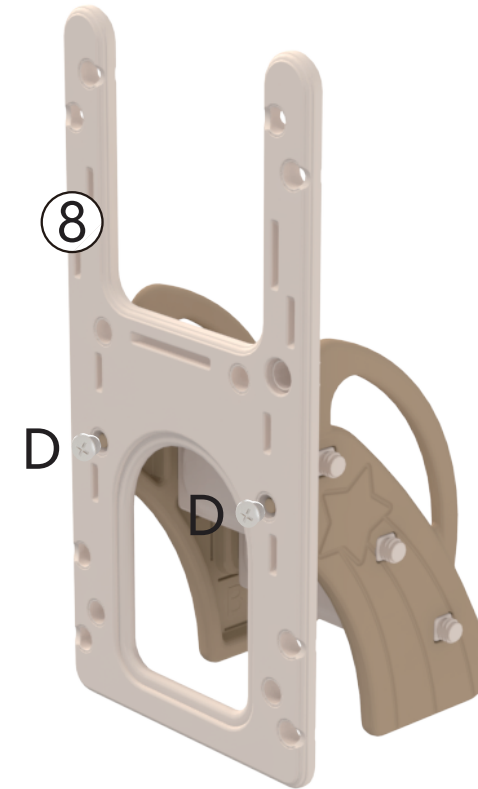
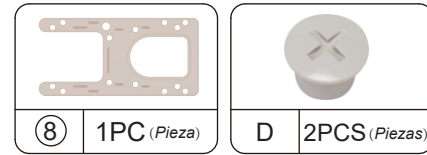

STEP 17/ Paso 17

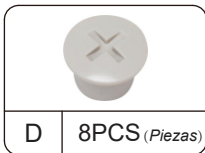

STEP 18/ Paso 18

