

# aquataps

THE FILTERED TAP COMPANY

## AQUATAP FIZZ DIGITAL MODEL

### Installation & User Guide

THE TAP FOR ALL



WELCOME TO YOUR BRAND NEW



aquatap **FIZZ DIGITAL**

5 in 1 BOILING WATER TAP

## **IMPORTANT NOTICE:**

When correctly installed and maintained with care, your Aquataps boiling water tap will give you many years of trouble free service. **This product is not for outdoor use.** This product can cause harm if installed incorrectly. Should you decide to install this product yourself, please read this guide carefully first. If you have any questions please contact us or a professional installation service.

**Please read and fully understand all installation instructions before installing and using this application. If in doubt contact a qualified plumber or retailer to assist.**

Check that no parts are missing or damaged. If parts are missing do not install and contact our customer services.

A standard 220/240v grounded 13 amp switched electrical outlet is required under the sink for the appliance's electrical power. The Aquataps instant hot water tank is only intended for use with compatible Aquataps boiling water taps. Using this tank with any other tap will invalidate the warranty.

Do not plug in the tank until all water connections have been checked, is watertight and the tank has been filled. The tank is filled once water starts to pass out the tap spout. It is recommended before using the tank, to flush through several litres of water to remove any air in the system when installing.

Please note, that in order to avoid having pressurised boiling water and to comply with UK byelaws, this is an open vented system. In order to ensure the instant hot water tank delivers the highest quality drinking water and is protected from limescale build up, the water filter must be replaced **every 6 months**. Failure to do so may invalidate your product warranty.

Contact us at **info@aquataps.co.uk** or these can be purchased online at **www.aquataps.co.uk** or by calling **01268 727823**



- To prevent against electrical shock do not place the hot water tank near or in water or other liquids and install on a flat surface.
- Do not install in environments above 35°C or exposed to freezing.
- Do not operate or install electrical connections with wet hands
- Do not install the appliance if it appears damaged in any way
- Only use the power lead supplied with the product. If the power lead is damaged, stop using immediately and contact customer services for a replacement.
- Do not remove tank casing, this product is not serviceable and should be returned to the manufacturer in the event of a fault.
- Do not modify the tank or remove the plug as this will invalidate the warranty and could cause serious injury. Designed for UK 3 pin socket only.
- If the unit is unused for extended periods of time it should be unplugged, drained, re-filtered and refilled.
- The tap and water tank can be cleaned with a lint free damp cloth.
- Do not use any abrasive or corrosive cleaning products as this will damage the surface of the product.
- Replace the filter every 6 months



# aquatap FIZZ DIGITAL

5 in 1 BOILING WATER TAP

1x **A** 5 in1 digital tap

1x **B** Rubber washer

1x **C** Metal washer

1x **D** Fixing nut

1x **1** Cold water inlet hose

1x **2** Hot water inlet hose

1x **3** Filtered and Sparkling water inlet hose

1x **4** Boiling water inlet hose

1x **5** Braided hose from mains cold to filter

1x **6** Braided hose from junction box to boiler

1x **E1** Electronic Signal Connector from Tap

1x **7** Junction Box and **E2** Signal Connector

1x **8** Junction Box Power Cable

1x **9** 3-way Metal T-piece

1x **10** 3-way Plastic push fit connector

6x **11** 1/4" plastic tubing

1x **12** Plastic push fit 2 way divider

2x **13** Allen key



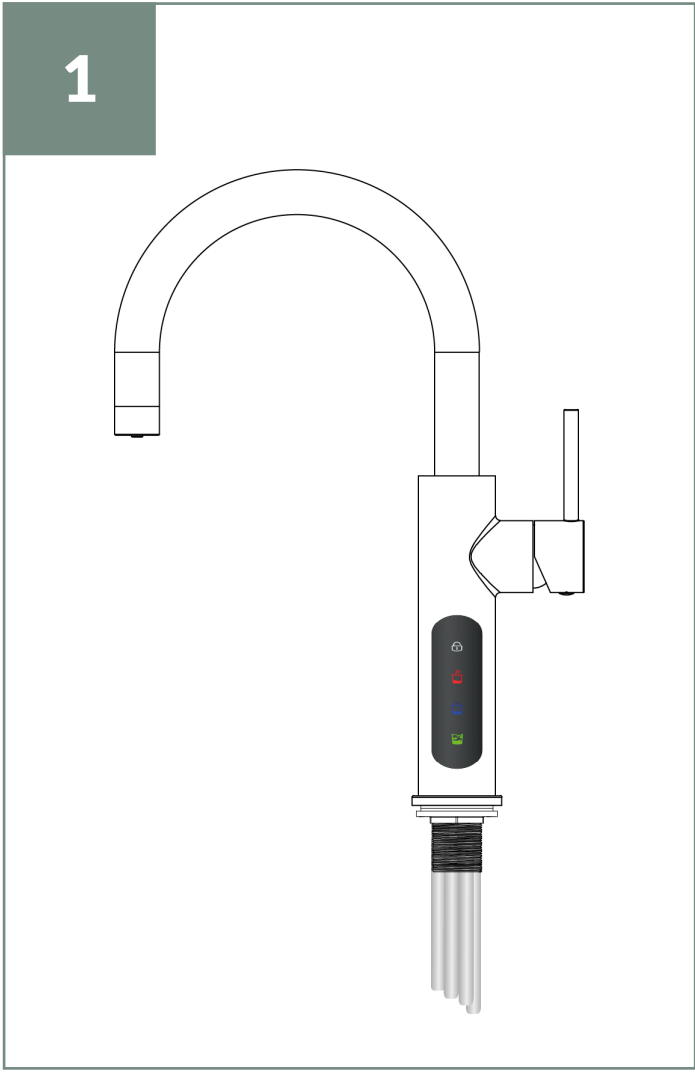

Remove the rubber washer (B), metal washer (C), and fixing nut (D) from the base of the tap. Then put all the flexible hoses and electronic signal connector (E1) through the tap hole.

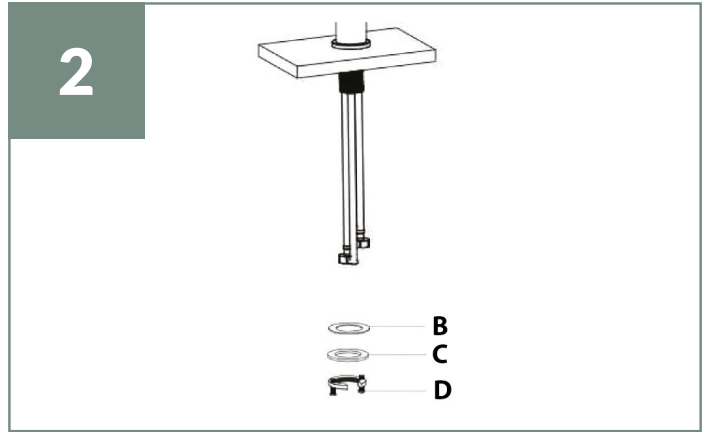

Put the rubber washer (B), metal washer (C), and fixing nut (D) back onto the tap by feeding the hoses and electronic signal connector (E1) through them. Fix them onto the thread at the base of the tap and tighten by hand.

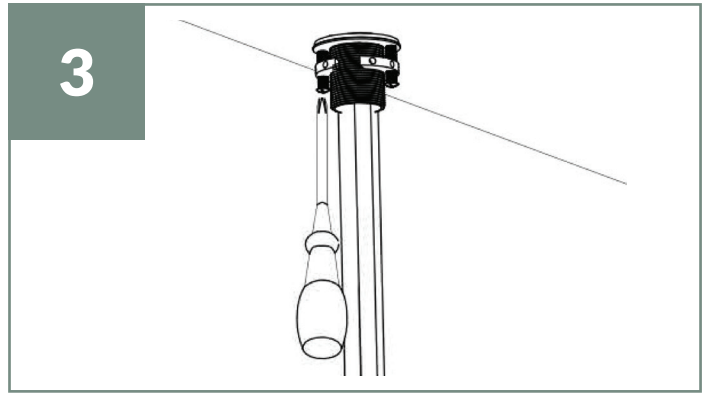

Use a philips screwdriver to tighten the two fixing screws.

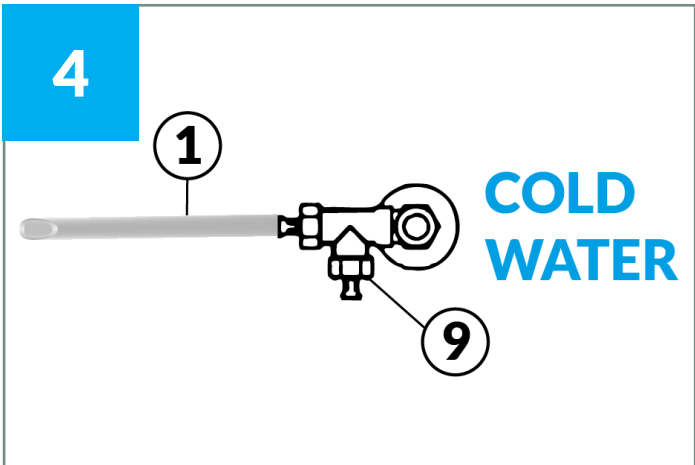

Connect the metal T piece (9) to your mains cold water supply. Then Connect the cold water inlet hose (1) to one side of the T piece and tighten it with an adjustable spanner.

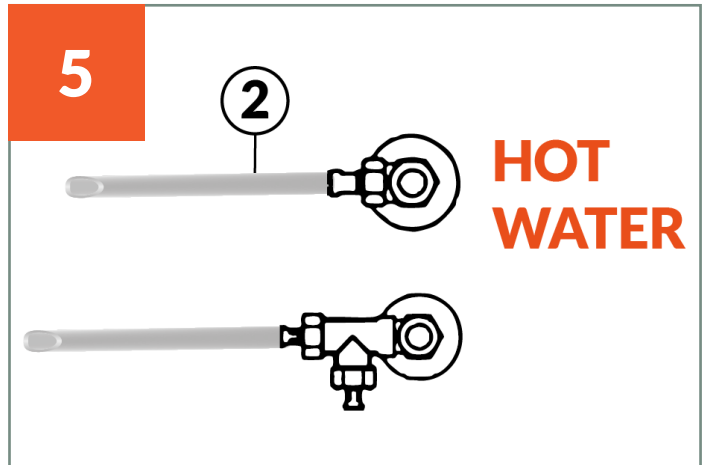

Connect the hot water inlet hose (2) to your mains hot water supply and tighten it with an adjustable spanner.

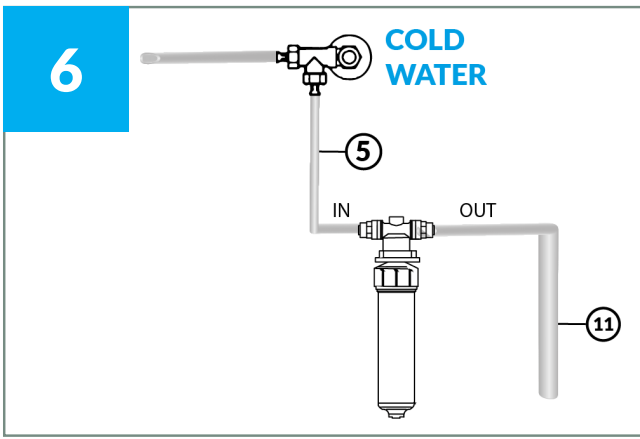

Connect hose (5) to the **metal T piece** on the cold mains and tighten it with an **adjustable spanner**. Insert the other end of the hose (5) into the filter's inlet. Take a piece of **1/4" plastic tubing (11)** and insert one end into the filter housing outlet.

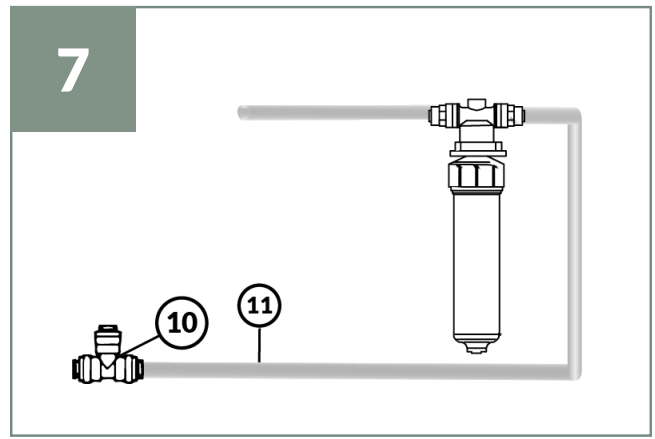

Connect the other end of 1/4" Plastic Tubing (11) to one side of the **plastic 3-way connector (10)** by removing the blue clip first and then re-attach the clip to secure into place.

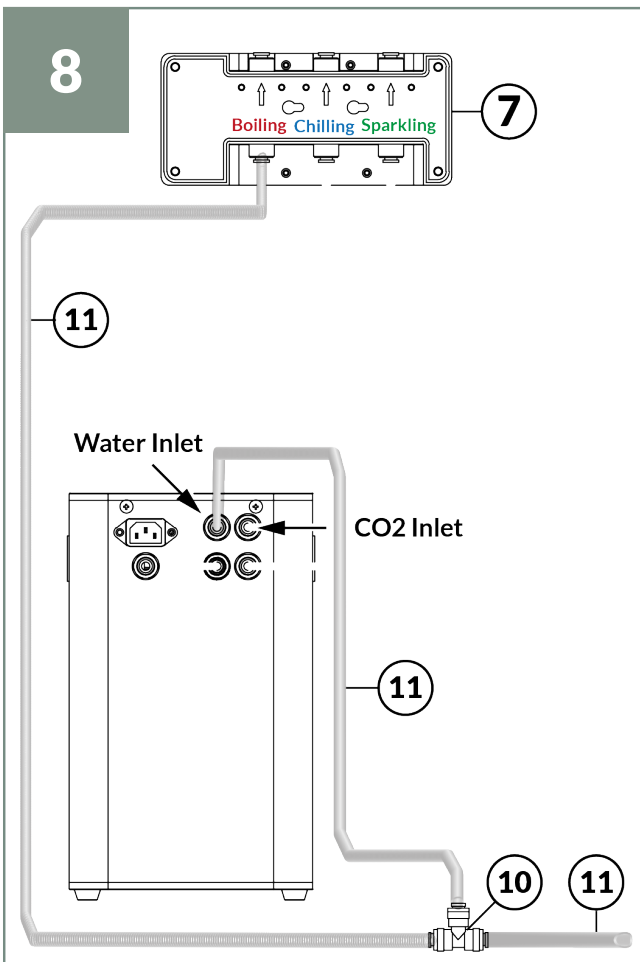

Take another 2 pieces of 1/4" plastic tubing (11) and connect them both to the **plastic 3-way connector (11)**, by removing the blue clip first and then secure by using the blue clip once attached. Connect one of the tubes to the **Water Inlet of the Chiller**. And the other tube to **Boiling Inlet of the Junction Box (7)**.

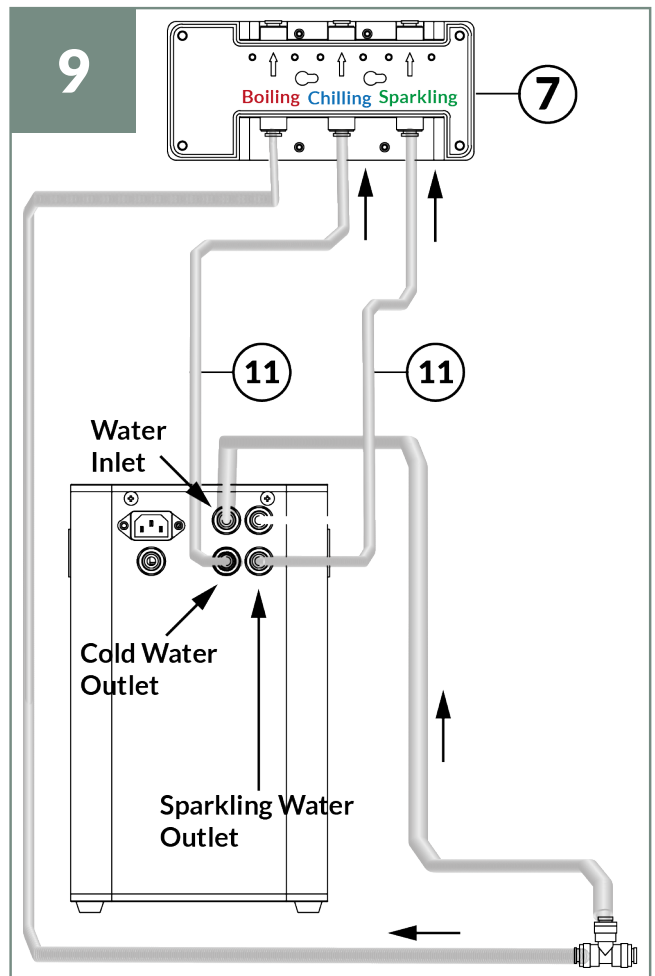

Take another 2 pieces of **1/4" plastic tubing (11)**. Use one to make a connection between **Cold Water Outlet on Chiller to Chilled Water Inlet on Junction Box (7)**. Then use the second piece to make a connection between **Sparkling Water Outlet on Chiller to Sparkling Inlet on Junction Box (7)**.

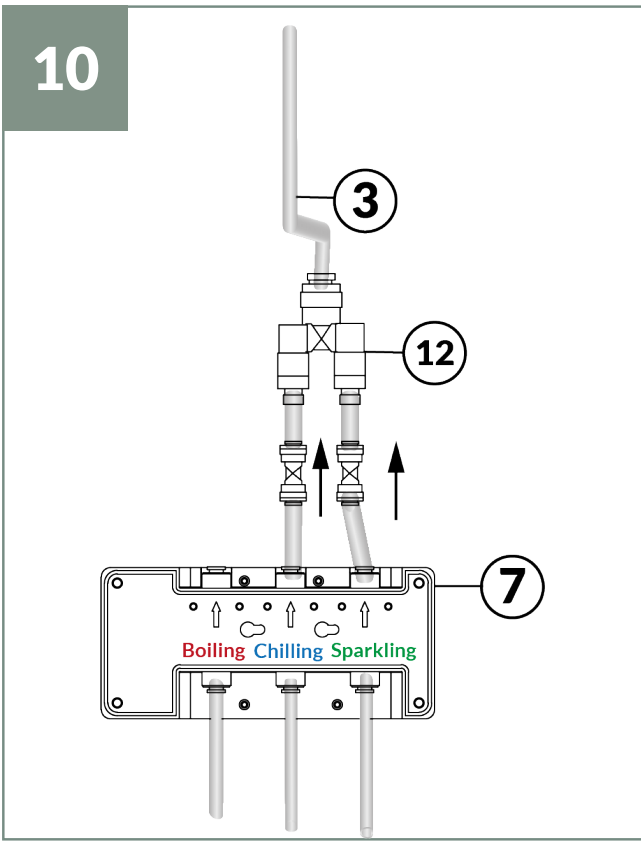

Connect hose (3) coming from the Tap to the singular end of the Plastic 2 way diverter (12). Connect the other 2 ends of the Plastic 2 way diverter (12) to the Chilled and Sparkling Outlet on the Junction Box (7).

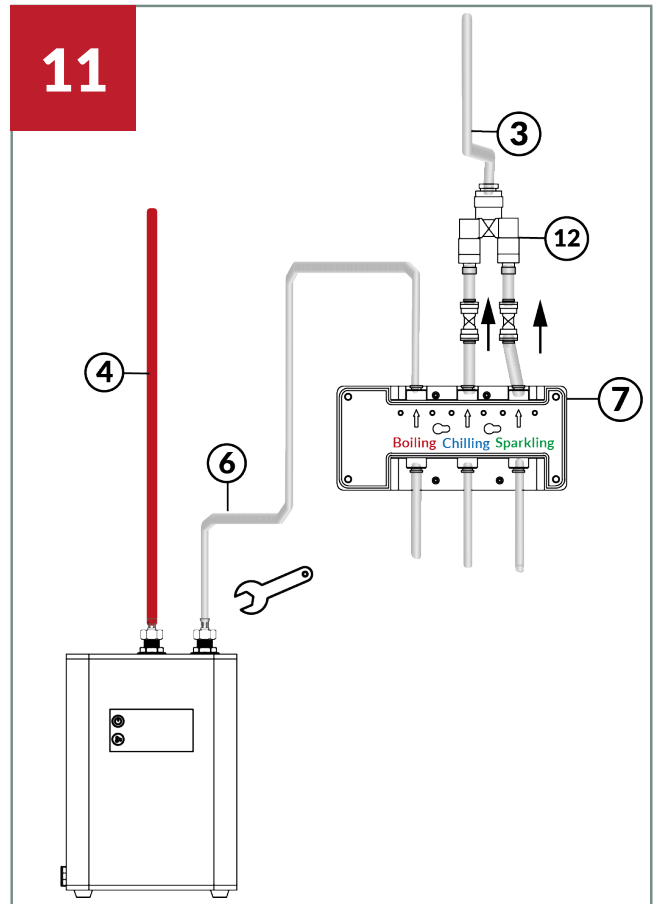

Connect hose number (6) to the Boiling outlet of the Junction Box (7) and the other end to the inlet of the Boiler. The inlet of the Boiler is marked Blue. Then remove the rubber washer that is attached to hose number (4). Secure hose (4) to the Boiler outlet (marked Red) with the washer placed inside of the connection. Both connections to boiler should be hand tightened and then using an adjustable spanner another half turn. Over tightening may damage the boiler.

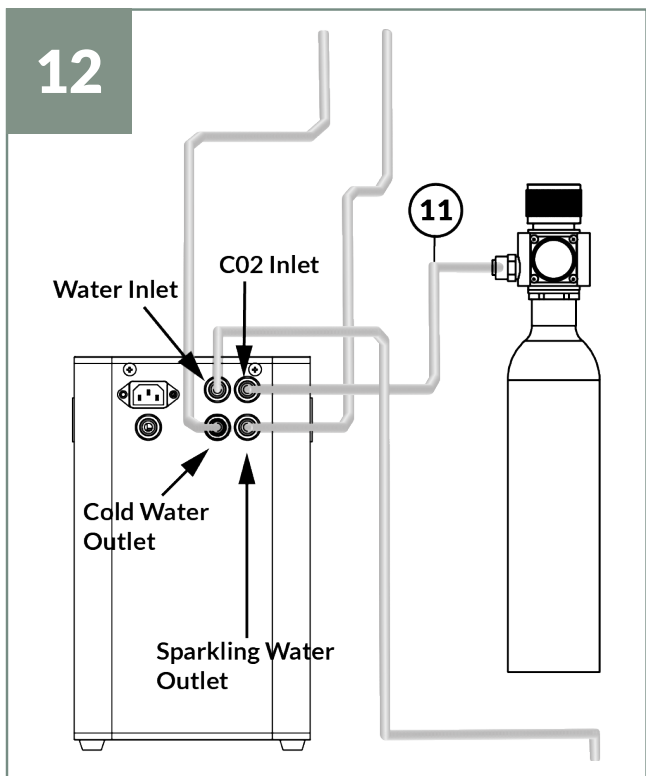

Connect the CO2 using 1/4" Plastic Tubing (11) and connect to **CO2 inlet** on the Chiller.

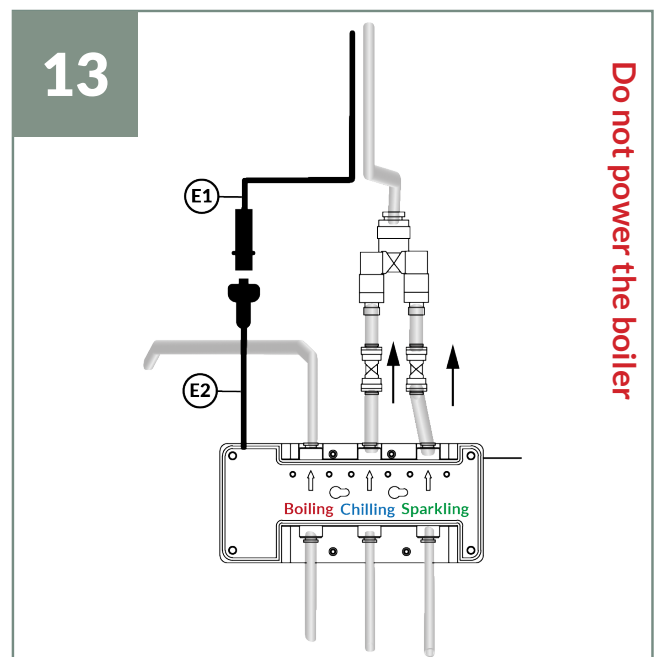

Connect E1 and E2 Electronic Signal cables together and insert the power cables to the Boiler, Chiller and Junction Box but do not switch on.

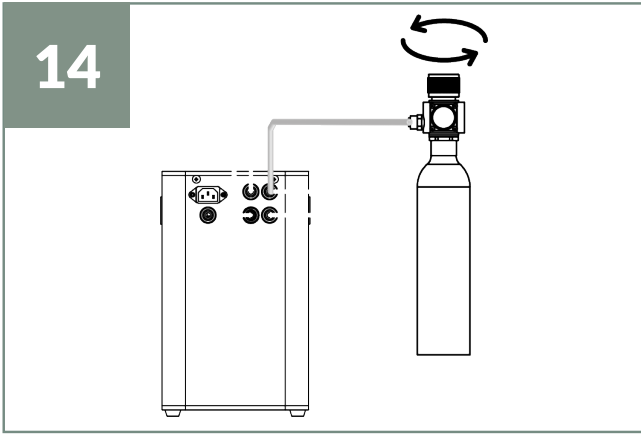

Turn on the CO2 and set it to 3.5 barr of preasure.

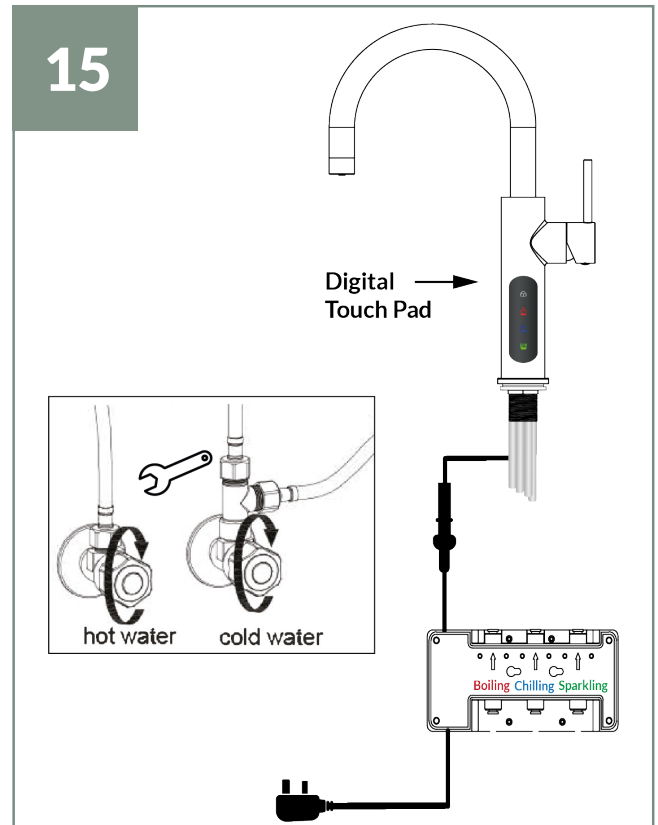





Turn on your mains hot and cold water, check and ensure no connections are leaking. Turn the power on for the Junction Box. **Lights** should appear on the **Digital Touch Pad** of the Tap.

16

Hold 3 seconds to unlock Water Functions.

Touch and hold Boiling Water Function until water starts to come out from the Tap.

1. To **activate the Digital Touch Pad**, touch the **lock button** until the other functions illuminate.
2. Touch and **hold Boiling Water Function (Red)** until water starts to come out from the Tap.
3. You will need to **wait for the Boiler to fill** before any water comes out from the Tap.
4. The **Chiller Tank** should automatically fill.

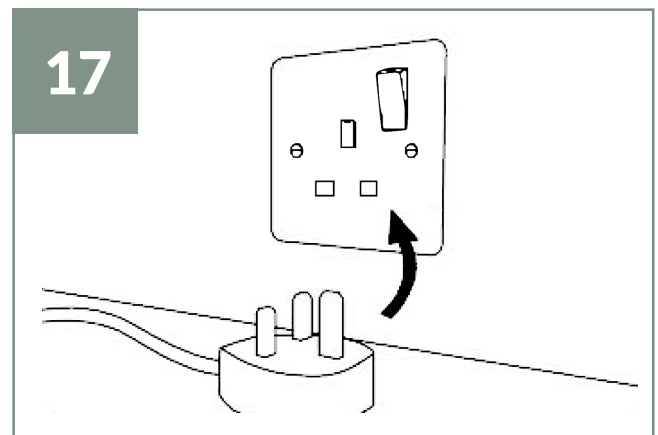

Once the Boiler and Chiller tanks have been filled, turn the **power on for the Chiller and Boiler**.

**Allow The Chiller to chill before using chilled and sparkling water.**

aquataps  
THE FILTERED TAP COMPANY

## CUSTOMER CARE

Tel: 01268 727823

Email: [info@aquataps.co.uk](mailto:info@aquataps.co.uk)

[www.aquataps.co.uk](http://www.aquataps.co.uk)