

# PRODUCT CARE HANDBOOK

a guide to protect your product



866-504-7728



support@guyii.com

[www.guyii.com](http://www.guyii.com)

Thank you for purchasing this product. Please read these instructions fully before starting assembly, then follow the simple step by step guide.

### TOP TIPS BEFORE YOU START!

1. Please check that all parts & hardware are present before you start the assembly of your furniture. Do not destroy any of the packaging until you are certain that you have all the necessary parts for assembly.
2. To ensure a smooth installation, we recommend that before you commence each step of the assembly, please identify all the parts required for that step.
3. We recommend that where possible, all items are assembled near to the area in which they will be placed in use, to avoid moving the product unnecessarily once assembled.
4. For the protection of your furniture, particularly items of high gloss finish, we recommend that the product is placed on a protected surface during assembly to prevent any damage.
5. During assembly, please take care not to over-tighten any fittings, as this may damage the product.
6. Keep children and animals away from the work area. Small parts could cause choking if swallowed.

## Tools Required For Assembly

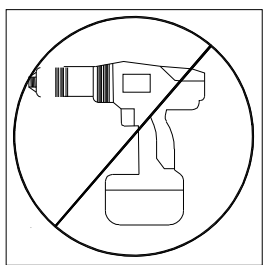

DO NOT USE POWER TOOLS TO ASSEMBLE THIS PRODUCT. USE OF POWER TOOLS WILL INVALIDATE ANY CLAIM AND MAY DAMAGE THIS PRODUCT MAKING IT UNSAFE.

Self-provided universal tool diagram:

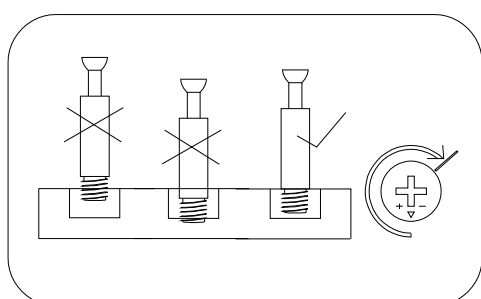
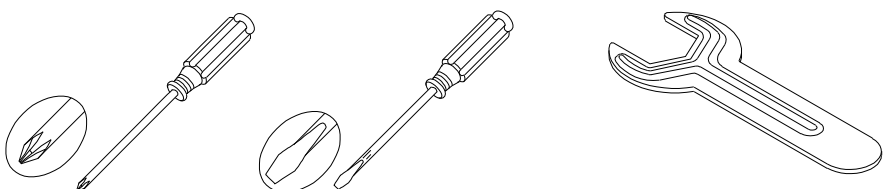

Rubber Hammer

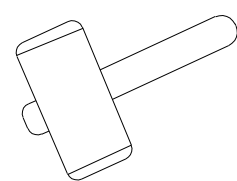

Tape Measure

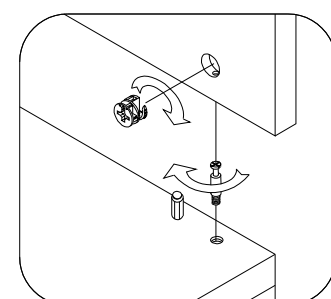
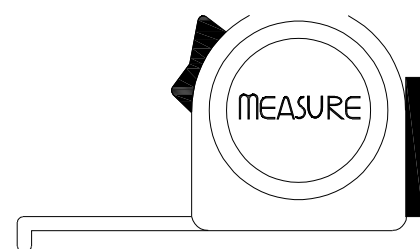

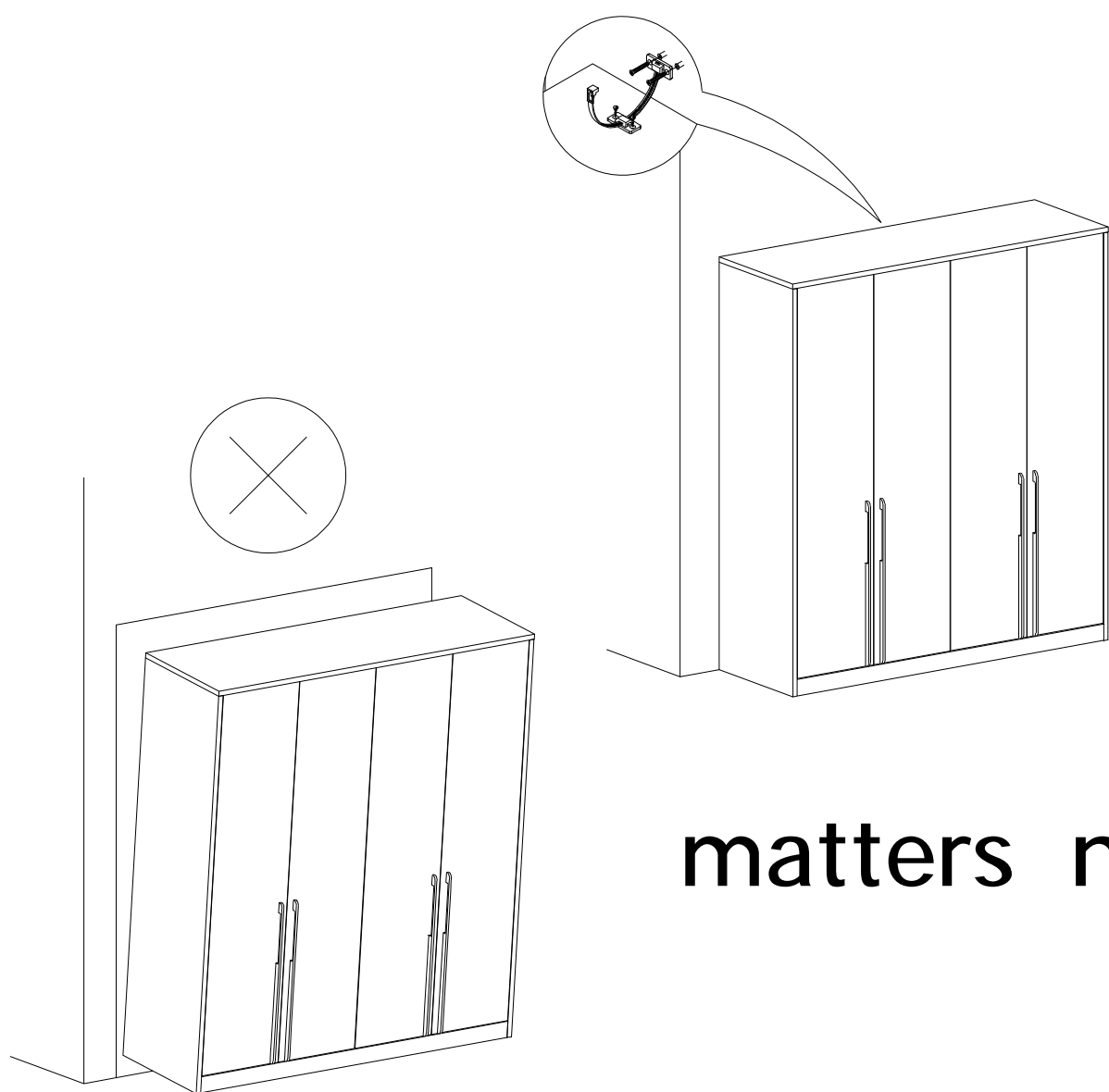

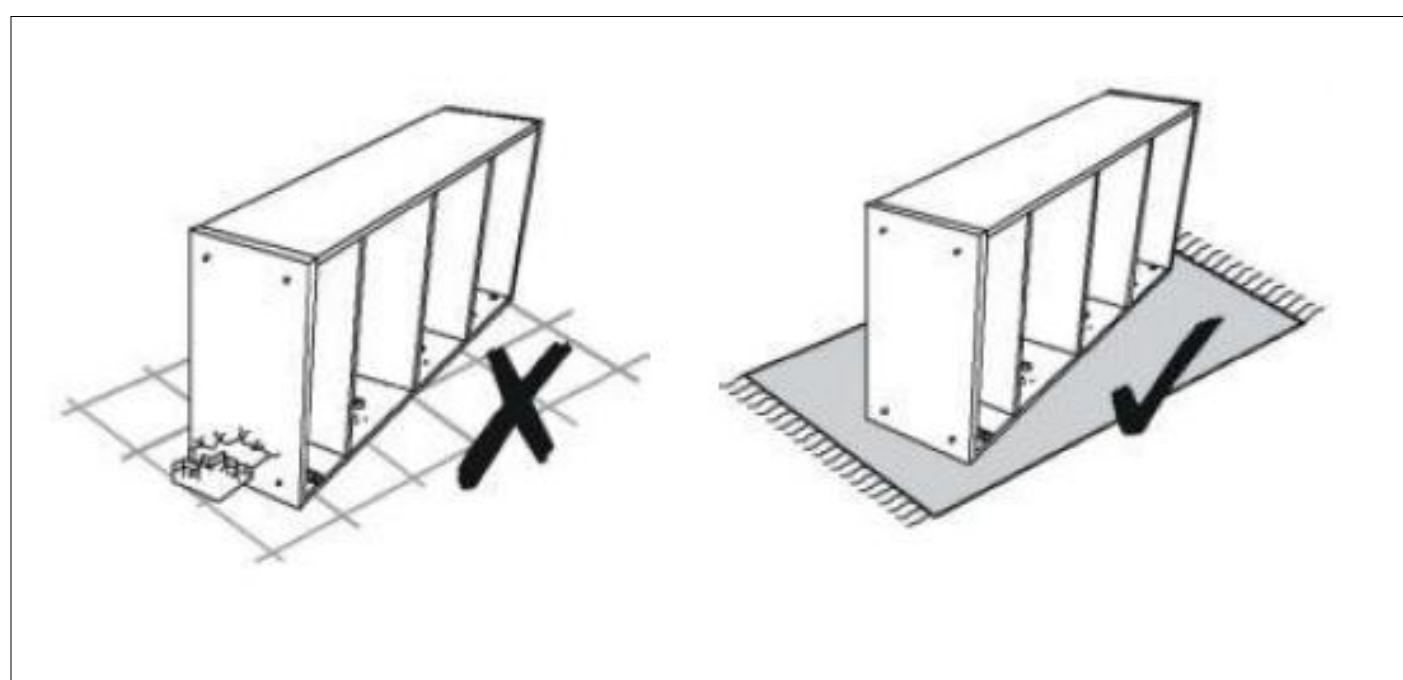
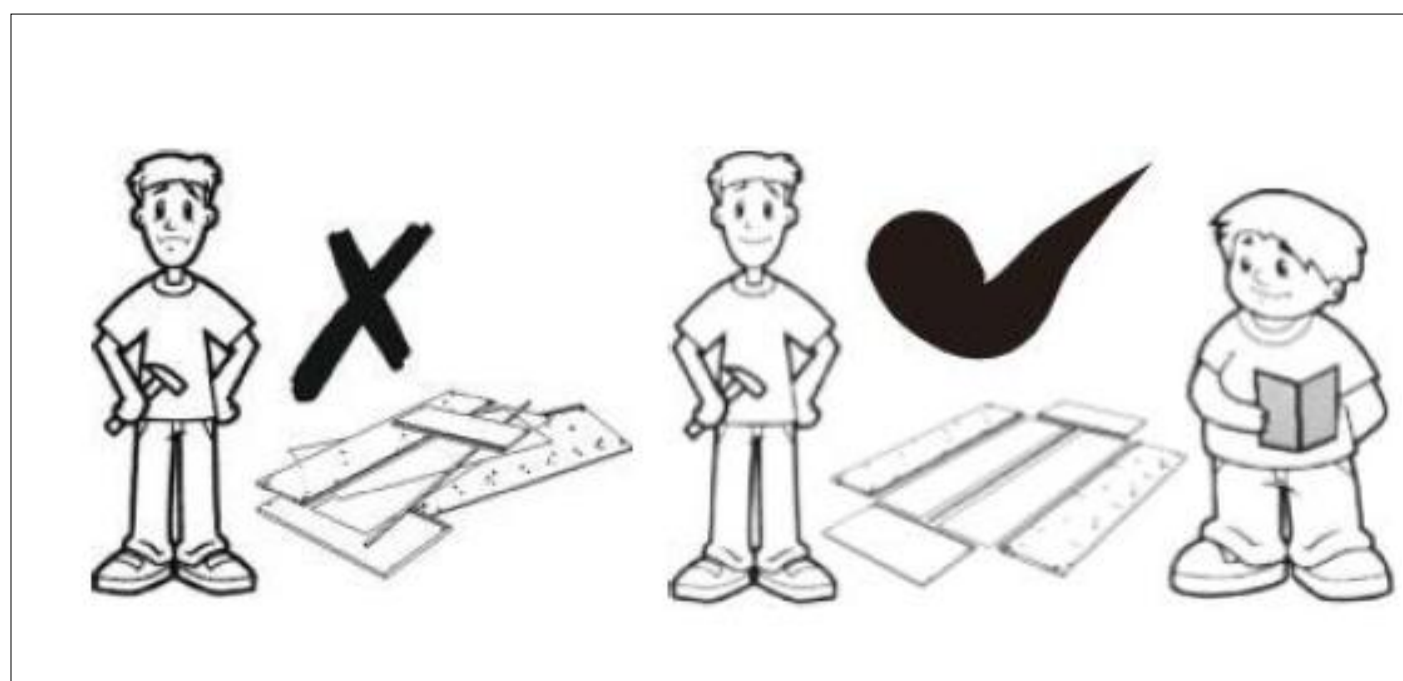

matters needing attention

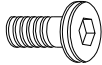

# GY1966HW - Side Table Assembly Hardware

<p>H6110(A)</p>  <p>Flat Head Allen Screw M8*8</p> <p>6PCS</p>	<p>H5106(B)</p>  <p>L-Shaped Allen Wrench 5#</p> <p>1PC</p>	<p>H1603(C)</p>  <p>Self-Adhesive Feet Φ30</p> <p>4PCS</p>		
---	--	---	--	--

# GY1966HW - Side Table Assembly Parts

B01*1 Tabletop	B02*1 Column	B03*1 Base	
----------------	--------------	------------	--

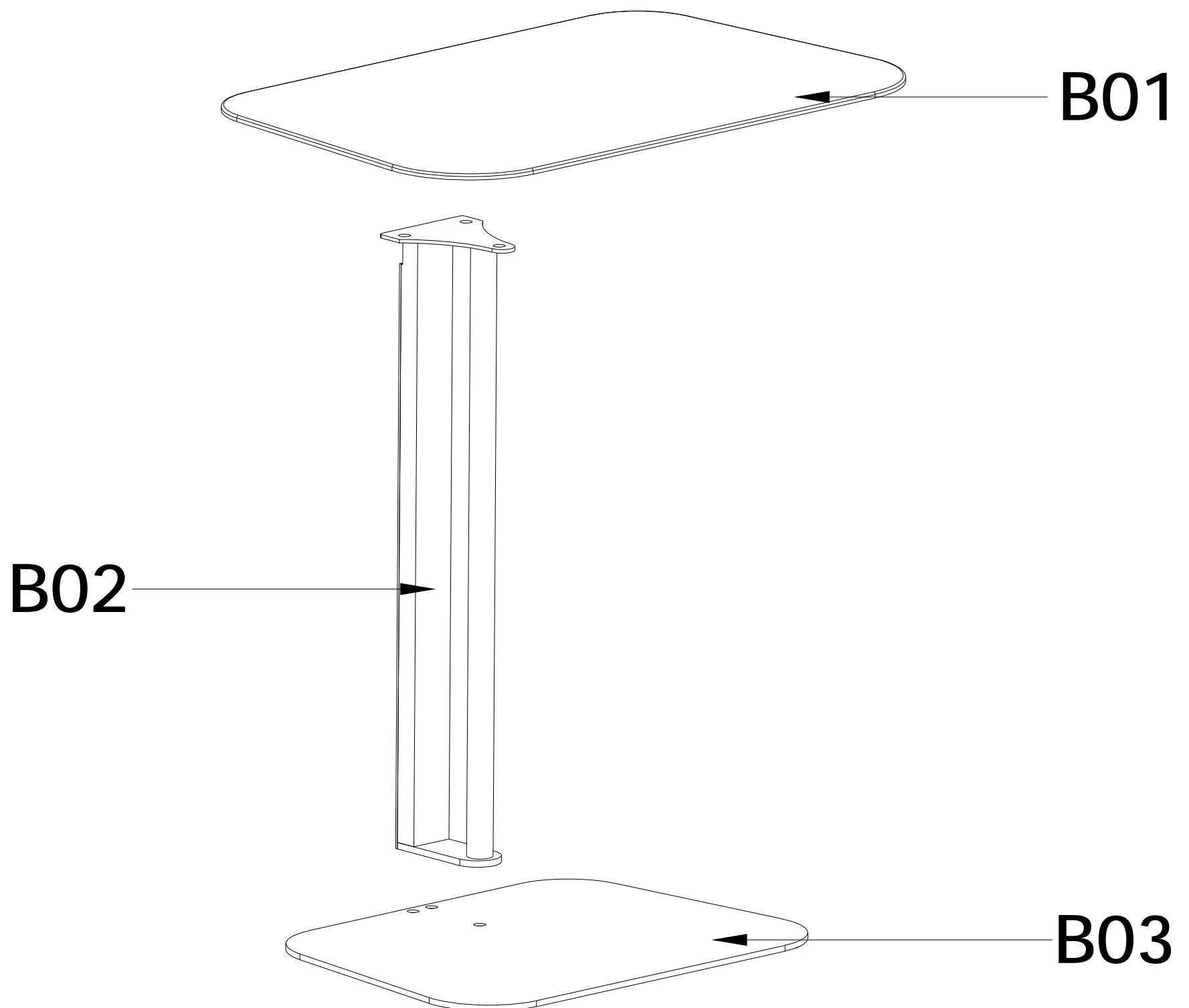

# GY1966HW - Side Table Assembly Steps

## Step 1

H6110(A)



3PCS

H5106(B)



1PC

B02

B01

H5106(B)

H6110(A)

## Step 2

B03

H6110(A)



3PCS

H5106(B)



1PC

H1603(C)

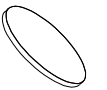

4PCS

H5106(B)

H6110(A)

H1603(C)

# WE'RE HERE TO HELP

how to get in touch with us



866-504-7728



support@guyii.com