

SOFA

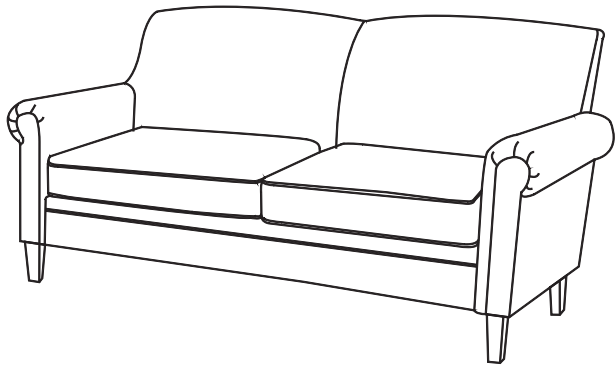
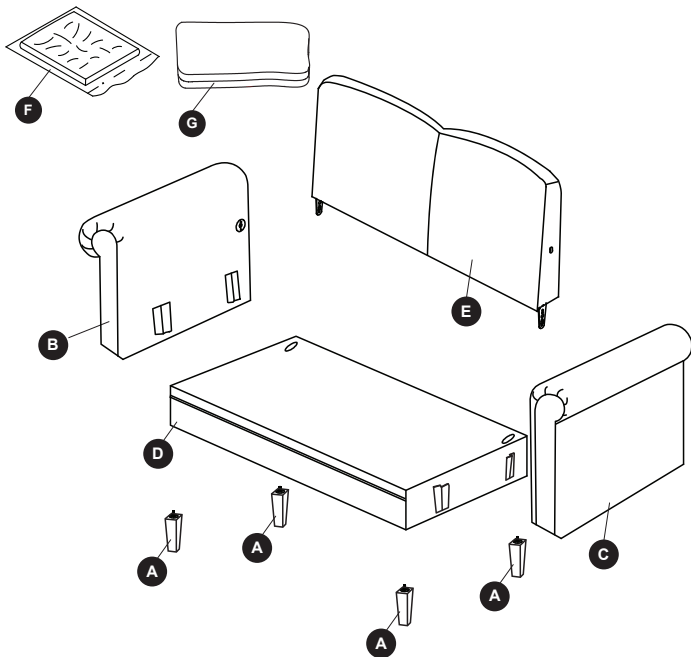

TABLE OF CONTENTS

Package Contents.....	3
Hardware Contents.....	4
Safety Information.	5
Assembly or Installation Instructions	8
Care and Maintenance	9
Troubleshooting	9
Replacement Parts List	9

PACKAGE CONTENTS



PART	DESCRIPTION	QUANTITY
A	Wood legs with washers	4
B	Armrest with "L" Label	1
C	Armrest with "R" Label	1
D	Seat frame	1
E	Back cushion	1
F	Seat cushions	2
G	Seat covers	2

HARDWARE CONTENTS (shown actual size)

AA



Thumb bolts
Qty. 2

SAFETY INFORMATION

Please read and understand this entire manual before attempting to assemble, operate or install the product.

Please read all instructions carefully before assembling this furniture. For your safety, assembly by two or more adults is strongly recommended. Use only vendor-supplied hardware to assemble this item. Using unauthorized hardware could jeopardize the structural integrity of the item. Hardware may loosen overtime. Periodically check that all connections are tight.

WARNING

- Remove all parts and hardware from the box. Place all items on a carpeted or scratch-free work surface, as this will avoid damaging parts during assembly.
- The shipping box provides an ideal work surface.
- To avoid accidentally discarding small parts or hardware, do not dispose of any packaging or contents of the shipping carton until assembly is complete.
- Use the parts and hardware lists below to identify and separate each of the pieces included.
- The use of power tools for assembly is not recommended. Power tools can damage the hardware and/or split the wood.

CAUTION

Dust often and use a vacuum cleaner crevice tool to clean seams. To maintain the appearance, gently clean soiled areas with a soft cloth dampened with a mild, water based detergent. Remove all lather and wipe with a clean damp cloth. Dry with another soft cloth by blotting the damp surface (do not rub).

Do not place furniture in direct sunlight and keep furniture at least 60 cm / 2 ft from heat sources to avoid fading.

PREPARATION

Before beginning assembly of product, make sure all parts are present. Compare parts with package contents list and hardware contents list. If any part is missing or damaged, do not attempt to assemble the product.

Estimated Assembly Time: 20 minutes

Tools Required for Assembly (not included): Scissors.



ASSEMBLY INSTRUCTIONS

1. Remove all parts from the carton and separate them into part number groups as indicated in the parts list. Open the box in the seat frame (D) and take out armrest with "L" label (B), armrest with "R" label (C), wood legs (A) and thumb bolts (AA).

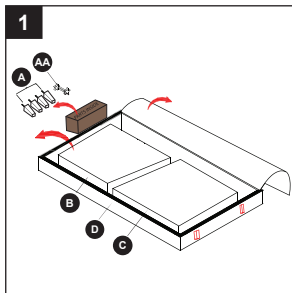

2. Remove the plastic caps on the threaded bolts of each leg. Attach wood legs with washers (A) to the bottom of the armrests (B & C).

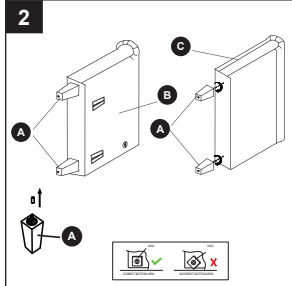

3. Lift seat frame (D) on the open end where hooks are located and let the downward facing hooks (b) slide into the upward facing hook slots (a) located on the inside of armrests (B).

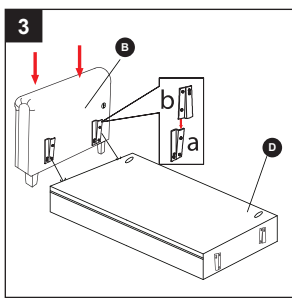

ASSEMBLY INSTRUCTIONS

4. Then lift seat frame (D) on the open end where hooks are located and let the downward facing hooks (b) slide into the upward facing hook slots (a) located on the inside of armrests (C) as shown.

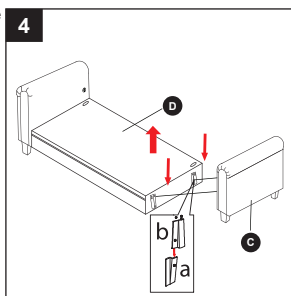

5. Slide the bottom of back cushion (E) into the slots of seat frame (D) as shown,

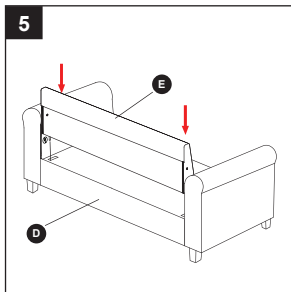

6. Make sure the holes in the back and inside of arms are aligned up and screw thumb bolts (AA) into the inside of arms through the back.

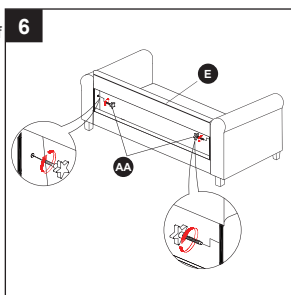

Hardware Used

- AA Thumb bolts  x 2

ASSEMBLY INSTRUCTIONS

7. Attach the back skirt of back cushion (E) to the bottom of seat frame (D) with velcro.

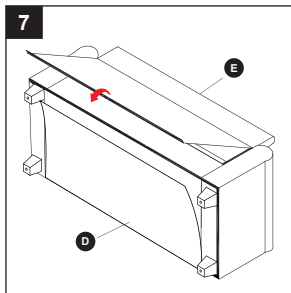

8. Cut the vacuum bag of seat cushions (F) and put them into seat covers (G) as shown.

Note: Seat cushions may take 24-48 hours to fully expand, which will allow wrinkles and indentations caused by packing to fade.

To close the zipper, please follow diagram 1. Failure to follow this could result in damage to the zipper.

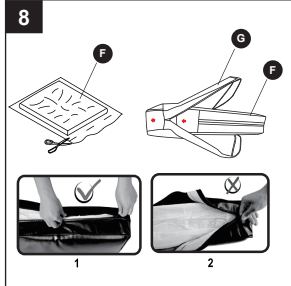

9. Then put cushions (F & G) on the sofa.
Now it is ready for use.

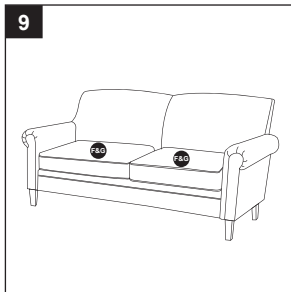

CARE AND MAINTENANCE

1. Do not stand on the seat cushion.
2. For indoor use only.
3. Please do not expose to direct sunlight.
4. Please do not place this product near sources of excessive heat.
5. Please avoid use of sharp objects on or near this product.
6. Use Fabric Cleaner on spills and marks, as general household cleaners can damage fibers and discolor fabrics.
7. Clean spills / marks immediately, as stains are harder to remove when they are left unattended.
8. For persistent stains and overall cleaning, contact a professional upholstery cleaning company.

TROUBLESHOOTING

PROBLEM	POSSIBLE CAUSE	CORRECTIVE ACTION
Wrong armrests	1. Armrests assembly wrong, corrective action	Before assembling armrests with seat frames, must make sure the armrest with "L" label attach to the side of seat frame with "L" label and the armrest with "R" label attach to the side of seat frame with "R" Label.

REPLACEMENT PARTS LIST

For replacement parts, call our customer service department

PART	DESCRIPTION	PART #
A	Wood legs with washers	1
B	Armrest with "L" Label	2
C	Armrest with "R" Label	3
D	Seat frame	4
E	Back cushion	5
F	Seat cushions	6
G	Seat covers	7
AA	Thumb bolts	8