

CARE AND MAINTENANCE









Unplug lamps before using any cleaning solutions. Dust shades with a feather duster or with an appropriate vacuum-brush attachment. Wipe with a soft, dry cloth and clean lamp bases with the methods appropriate to the material. Avoid the use of chemicals and household cleaners as they may damage the finish.

NOTICE & IMPORTANT SAFETY INSTRUCTIONS

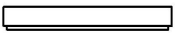
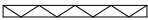
- * Please make sure that you have all parts indicated before you begin assembly of this item
- * This item should be assembled on a soft surface to prevent scratching the finish during assembly
- * To reduce the risk of fire, electrical shock or injury to persons or property, please follow the guideline below for safe use and installation
- *The external flexible cable or cord of this luminaire cannot be replaced;
If the cord is damaged, the luminaire shall be destroyed

**This portable lamp has a polarized plug (one blade is wider than the other) as a safety feature to reduce the risk of electric shock. this plug will fit in a polarized outlet only one way. if the plug does not fit fully in the outlet, reverse the plug, if it still does not fit, contact a qualified electrician. never use with an extension cord unless the plug can be fully inserted. do not attempt to defeat this safety feature.

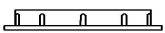
Part List and Hardware List

PIECE	DESCRIPTION	PICTURE	QUANTITY	PIECE	DESCRIPTION	PICTURE	QUANTITY
A	Lamp Body		1X	F	Bulb		1X
B	Lamp Base		3X	G	Tooth washer		1X
C	Socket		1X	H	Wrench		1X
D	Shade		1X	I	Parts		1X
E	Lamp head outer ring		1X	J	Hexagon nut		1X

Product Dimensions: 17"L X 12"W X 59"H

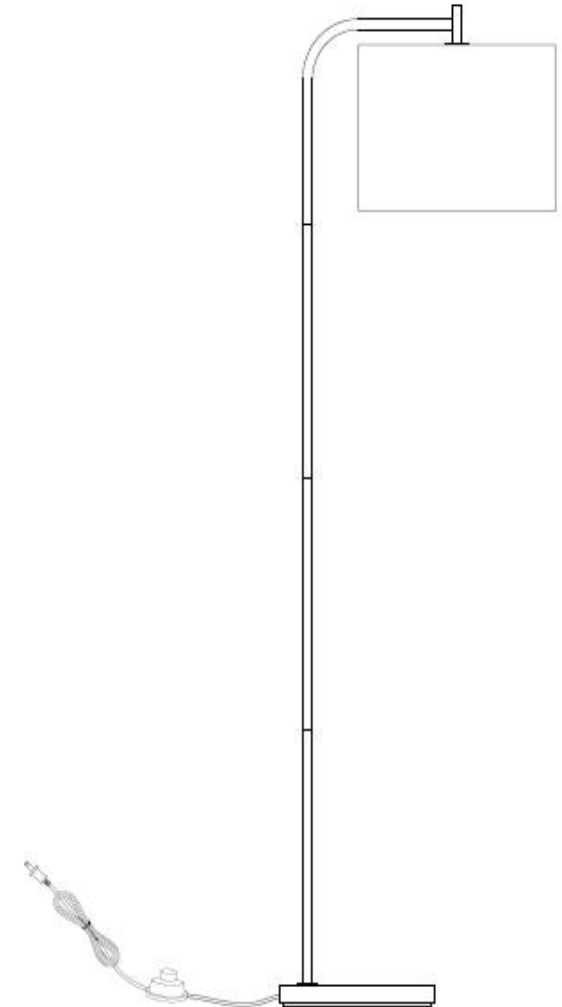

PREPARATION

Before beginning assembly of product, make sure all parts are present. Compare parts with package contents list and hardware contents list. If any part is missing or damaged, do not attempt to assemble the product.

Estimated Assembly Time: 15 minutes.

**PLEASE USE ON/OFF TYPE "A" BULB MAX 60-WATT OR CFL BULB MAX 13-WATT OR LED BULB MAX 9-WATT
THERE IS LED 9-WATT BULB IN THE BOX**

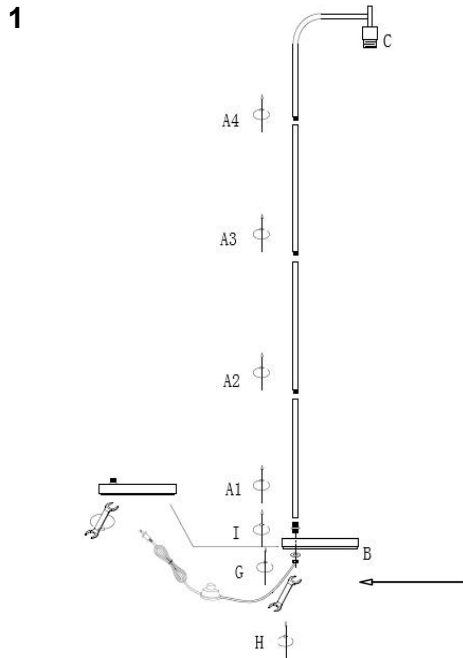

Step 1

Make sure all parts could be aligned before assemble

Do not rotate lamp body too hard avoid base screw broken

Separate the hexagon nut(J) and Parts(I) from lamp base(B) by using wrench(I) Insert the bulb(F) into the socket(C)

Screw the Lamp body (A3) onto the Lamp body(A4)

Screw the Lamp body (A2) onto the Lamp body (A3)

Screw the Lamp body (A1) onto the Lamp body (A2)

Screw the Parts(I) onto the Lamp body(A1)

Screw the lamp base (B) onto the Parts(I)

Screw the tooth washer(G) onto the lamp base(B)

Screw the Hexagon nut(J) onto the Parts(I) with wrench(H),and tighten securely

Be careful not to twist the power cord and tighten securely

ENJOY YOUR LAMP

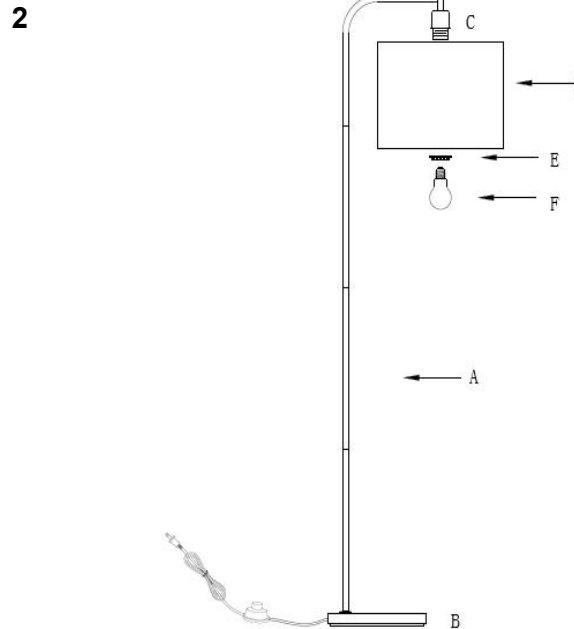

Step 2

Put the shade(D) on the socket (C)

Screw the ring(E) on the socket (C)

Insert the bulb(F) into the socket(C)

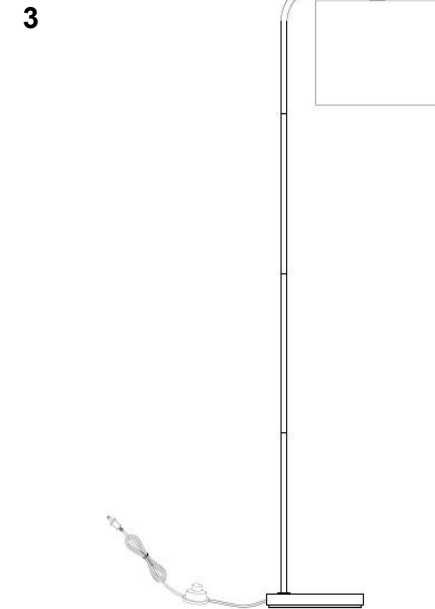

Step 3

Put the light on a level surface to check if everything is stable.