

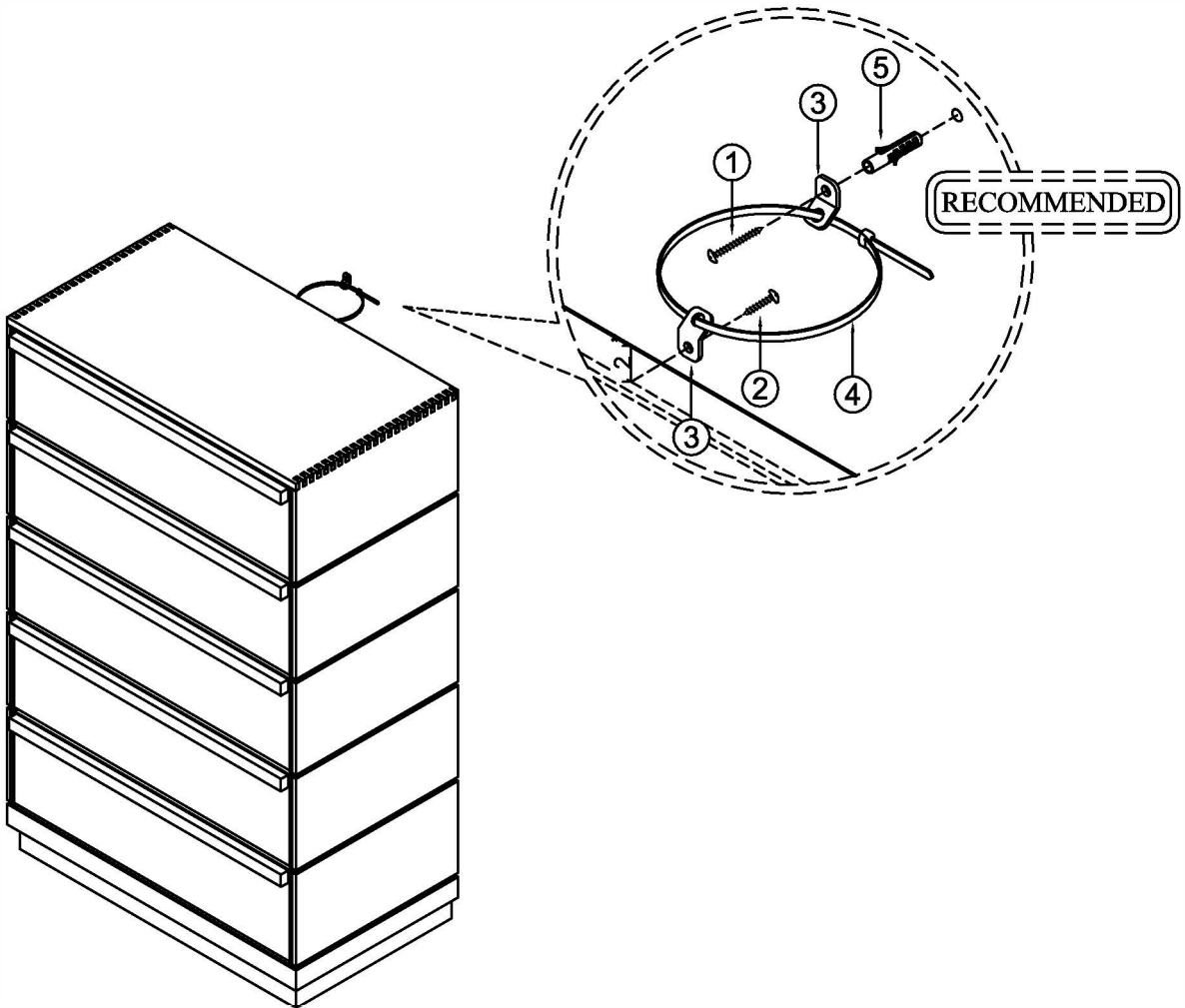

Assembly Instructions







ASSEMBLY RATING

The Assembly Rating is a 5-point system that shows the degree of effort needed in assembling a specific product (with 1 being easy and 5 being difficult). For some products, two persons are recommended.

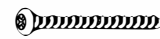
EASY  DIFFICULT

Tools Required For Assembly:

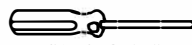
- 1. Long Screw 
- 2. Short Screw 
- 3. Metal Anchor 
- 4. Restraint Strap 
- 5. Fischer 
- 6. Philips Screwdriver 
(Not Included)



2 PERSONS RECOMMENDED