

WARNING!!

Furniture Tipping Risk.

Serious risk of severe or fatal crush injuries can occur from furniture tipping over if not secured.

Children like to climb on furniture and Unsecured furniture can pose a serious danger.

Please follow all instructions and install the tip-over restraints provided.



Assembly Instructions

Caution : You must read this before you proceed. This Headboard must be used in conjunction with a Mattress Support Frame (not included and not supplied with this headboard).

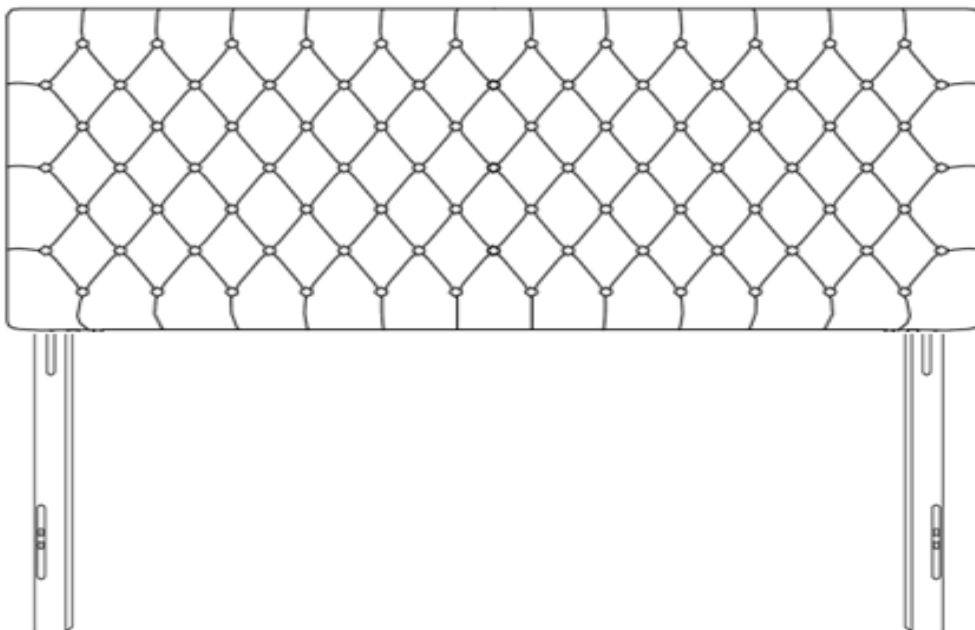



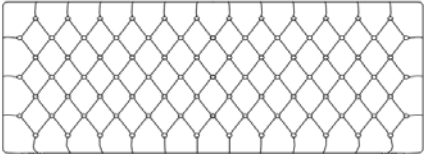

Headboard







Part List

Label	Picture	Description	Qty
A		Headboard	1
B		Left Support Leg with 3 Mounting Brackets (Labelled "Left" on the bottom)	1
C		Right Support Leg with 3 Mounting Brackets (Labelled "Right" on the bottom)	1

Hardware

Label	Picture	Description	Qty
a		Bolt (M8x25mm)	9
b		Spring Washer	9
c		Washer	9
d		Nut	5
e		Allen Key	1
f		Wrench	1
g		Screw (2cm self-tapping)	3

h		Screw (5cm self-tapping)	3
i		Restraint Strap	2
j		Metal Bracket	4
k		Screwdriver (not provided)	1

Assembly Preparation

Before Beginning Assembly:

Unpack and place all parts for clear visibility.

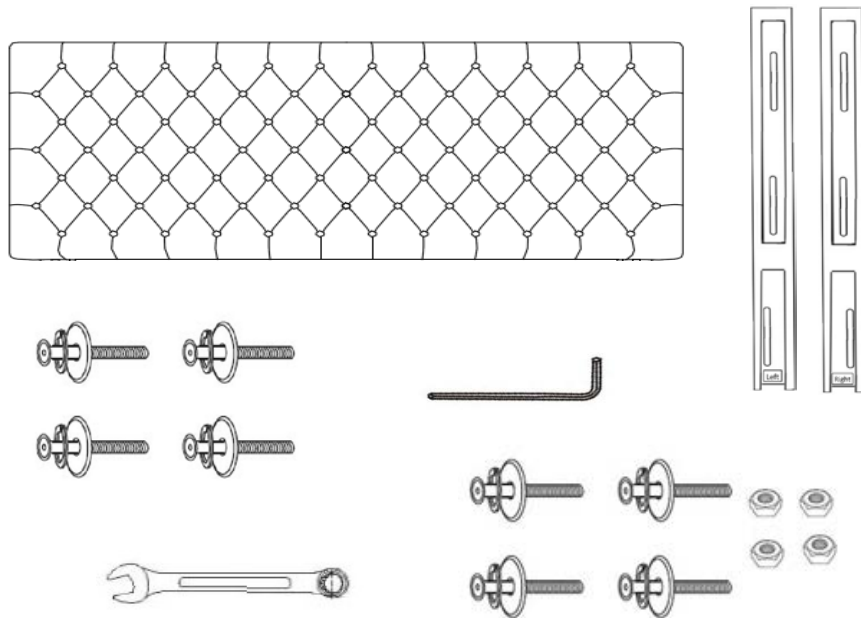

- Read instructions, cover to cover-



- Have 2 adults on hand for assembly-



- Do not assemble on flooring or carpet-



- Assemble on a clean non-marring surface (packing foam)-



- Save all packaging until finished-

Assembly Steps

Overview

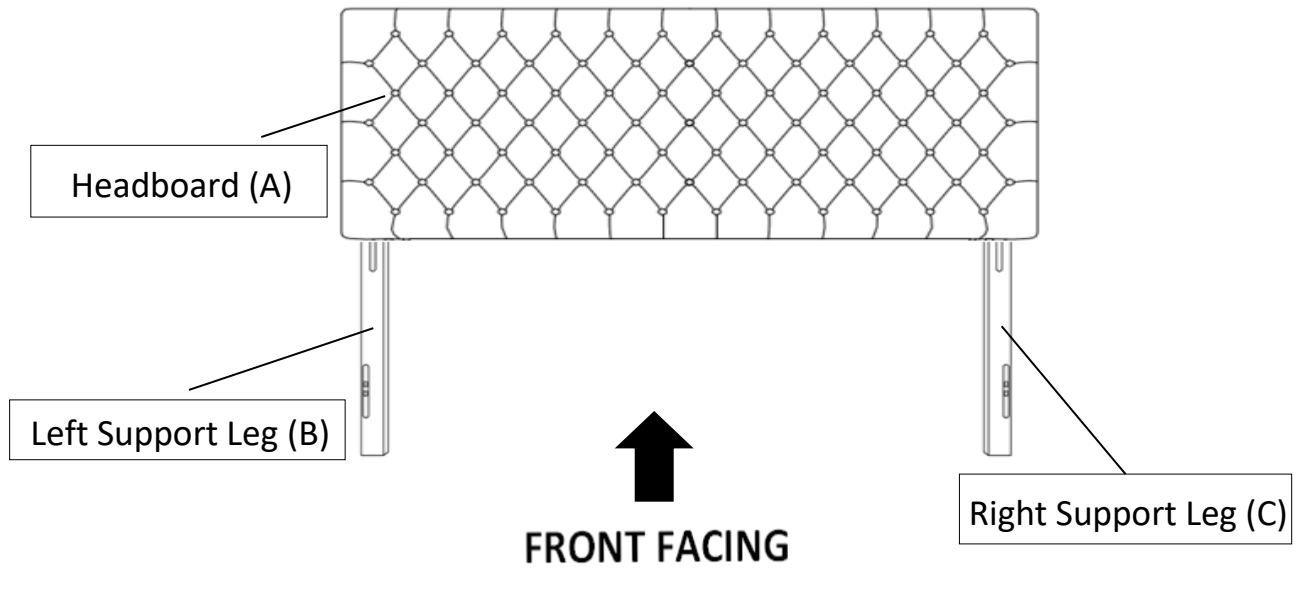

This Headboard has multiple parts and may require up to 30 minutes to assemble. To give you an overview of the Headboard parts, the above picture is to help you put the various parts into perspective. Please read through the instructions below to familiarise yourself with the parts and steps before assembly.

Step 1

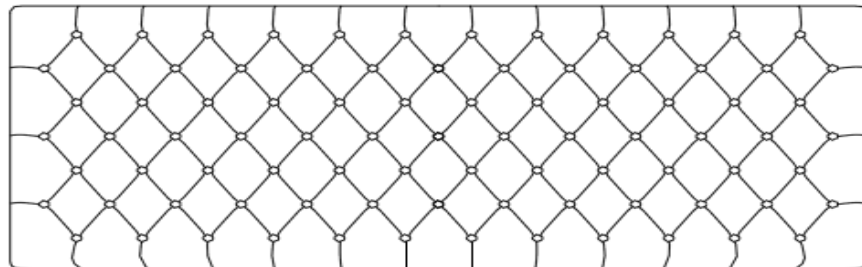

Headboard(A)

Place the Headboard(A) on a clean, non-marring surface.

Step 2

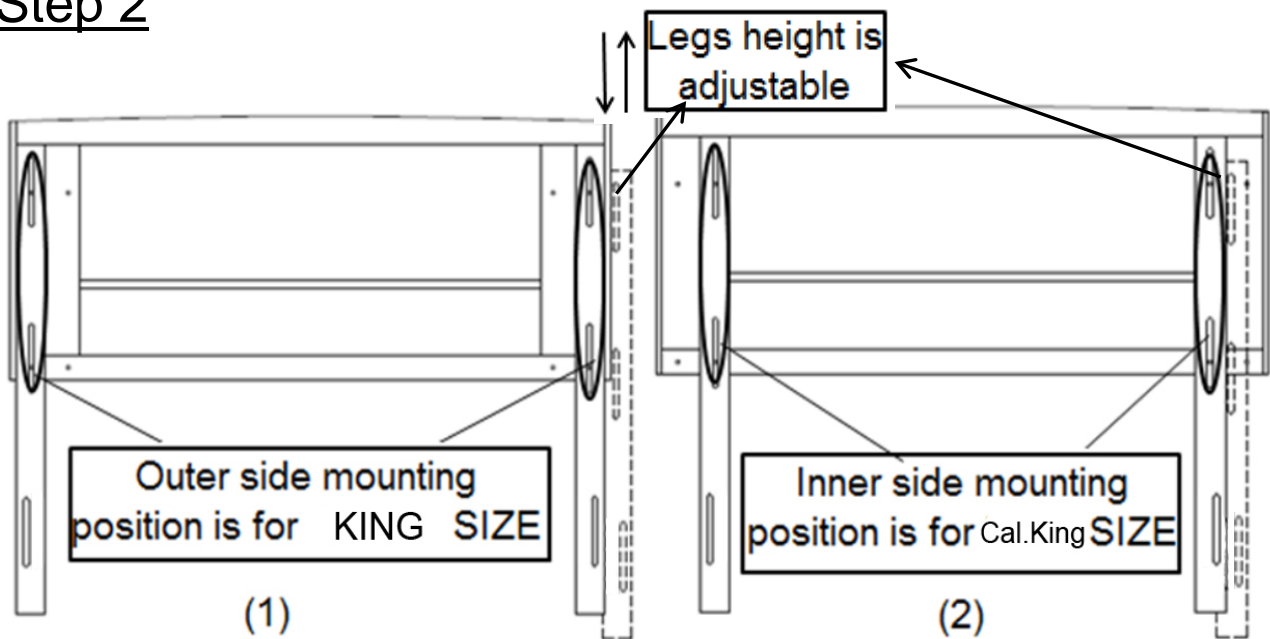

Put the Headboard(A) onto a flat table or panel.

Attach Left Support Leg(B) to Headboard(A) using Bolts(a), Washers(c) and Spring Washers(b) with Allen Key(e).

Repeat the same process to install the Right Support Leg(C).

King size assembly - picture(1); Cal King size - picture(2)

At this point of assembly, DO NOT fully tighten the Bolts.

The final height of the Headboard may be adjusted to your own need.

Step 3

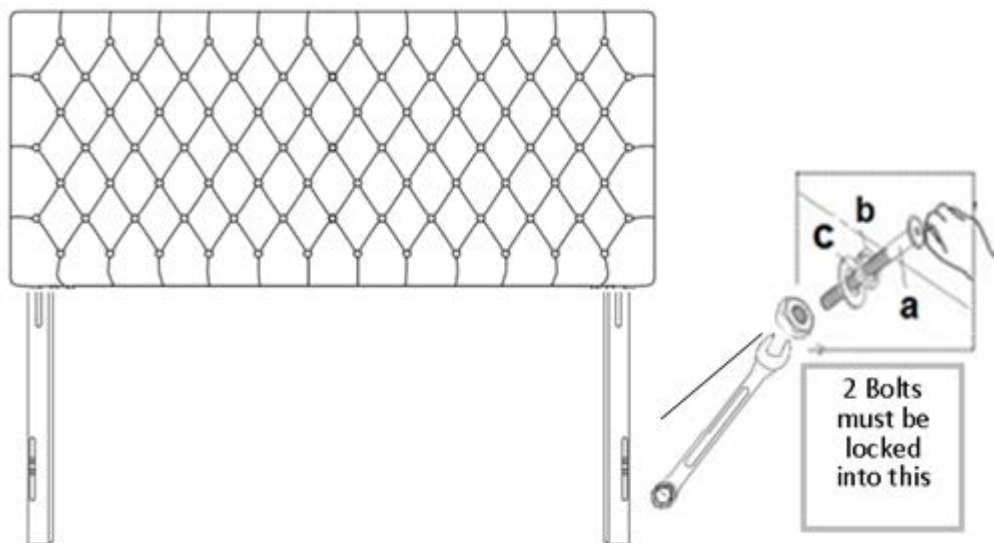

Next, hold the Headboard upright and align to the Headboard bottom mounting bracket to the Mattress Support Frame mounting bracket. Attach Headboard to the Mattress Support Frame using Bolts(a), Washers(c), Spring Washers(b) and Nuts(d) with Wrench(f).
Please install the Bolts from the FRONT TO BACK of the Headboard.

Step 4

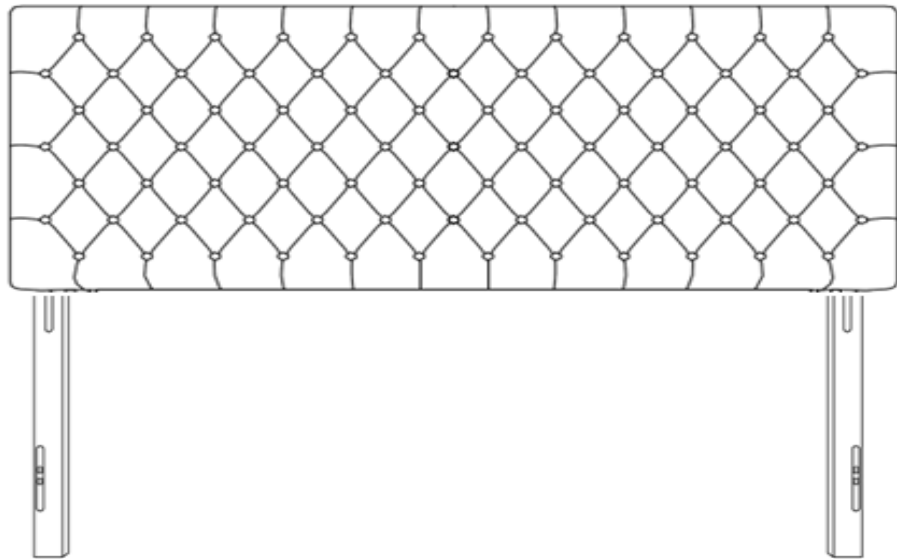

Make sure all parts are connected and securely locked into position. Your Headboard is ready for use.
This Headboard can only be used on a flat, level surface.



WARNING

Serious or fatal crushing injuries can occur from tipping furniture. To help prevent tip-over: ALWAYS secure this furniture to the wall using a Safety Restraint Device. See product instructions for more ways to help prevent furniture tip-over.

Headboard Restraint Device Installation Instructions

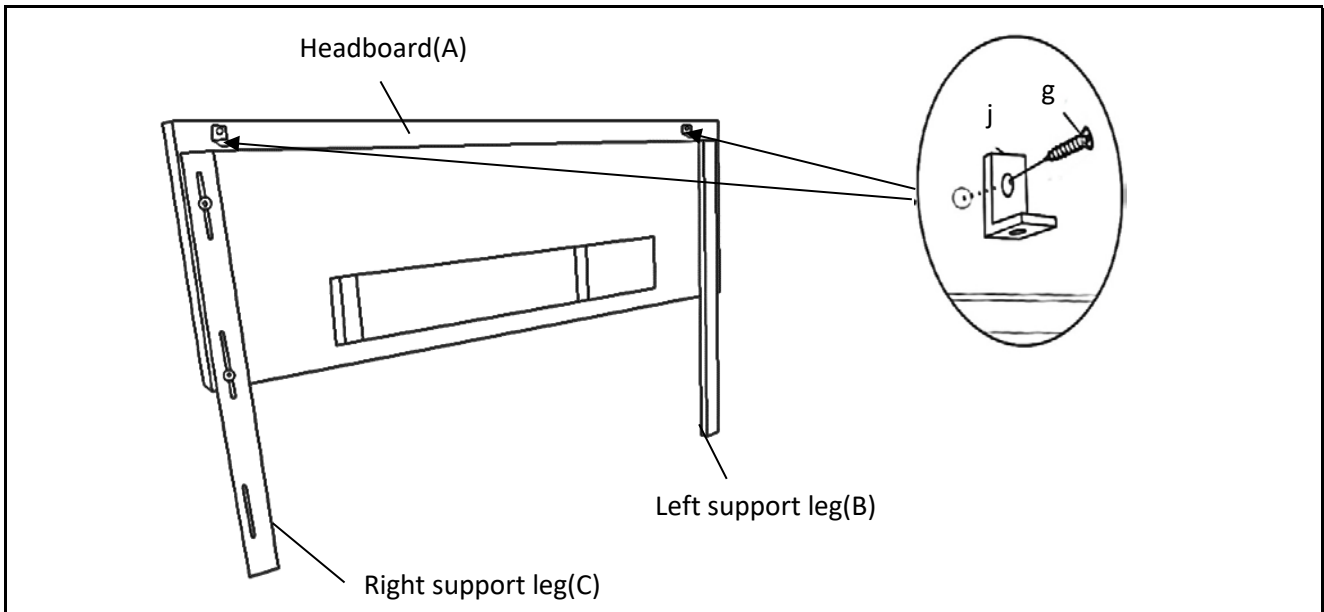

Firstly, turn back the Headboard.
 Find the two marks on the product.
 Then, attach Metal Brackets(j) to the back of Headboard(A) using Screws(g) with Screwdriver(k) as shown above.

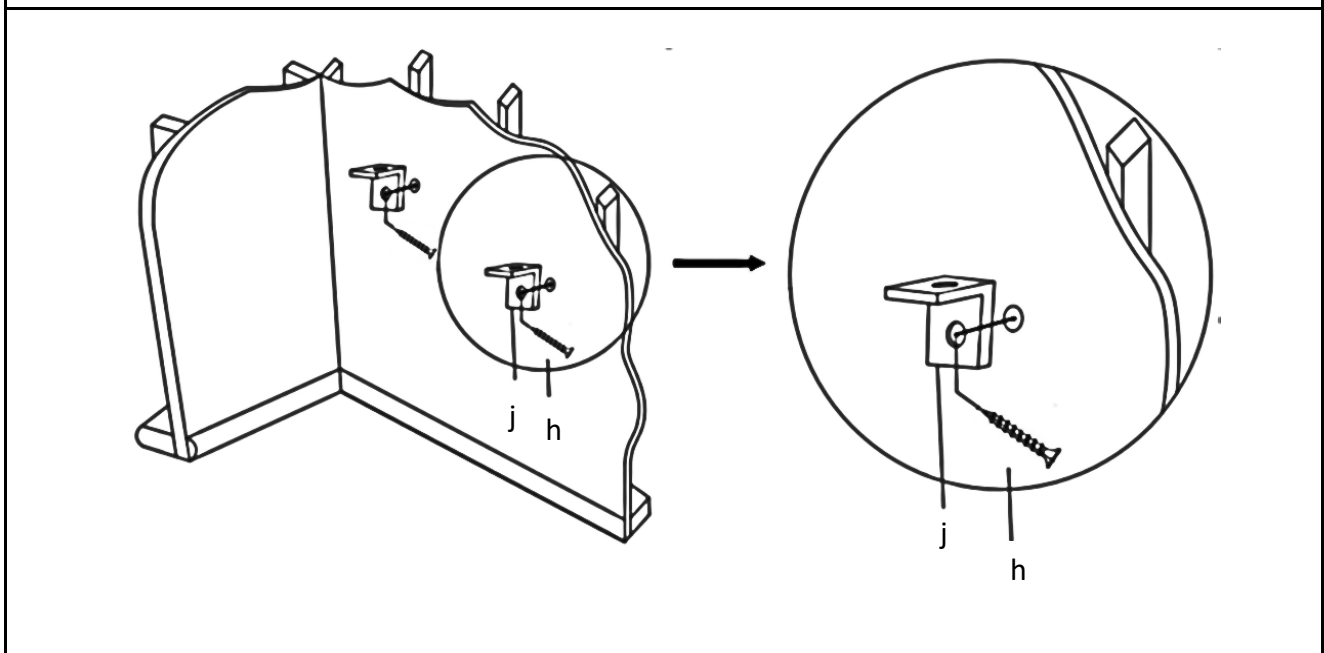

Put the Headboard against the wall where desired and mark the location for the Metal Brackets(j) to be the same height as the top of the Headboard.
 Attach Metal Bracket(j) to the wall where you marked using Screws(h) with Screwdriver(k).

Repeat this process with the other Metal Brackets(j).

Note: The Metal Brackets need to be secured to solid, load bearing surface. Please use a Stud Finder(not supplied) if needed to locate the Wall Frame.

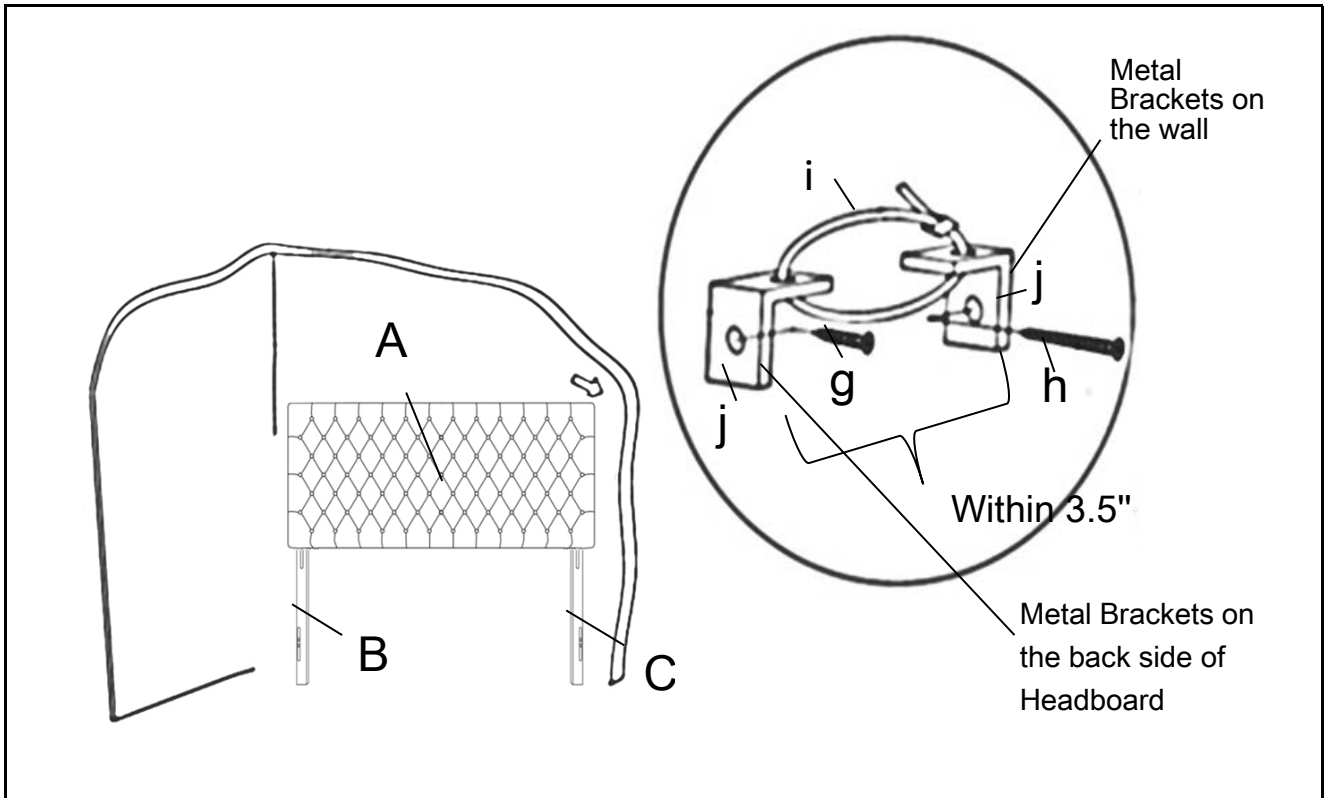







Move the Headboard back against wall.

Pull the Restraint Straps(i) through the Metal Brackets(j) on the wall and Headboard(A) one by one, and pull the Restraint Straps(i) tight.

Headboard Restraint Device is installed and Headboard is ready for use.

The strap between headboard(A) and Metal Brackets(j) on wall should be within 3.5".

Care & Maintenance

-  Do not put hot items directly on furniture surface
 -  Do not clean furniture with harsh cleansers or polish.
 -  Do not place furniture under direct sunlight.
 -  Do not place furniture near heating or cooling vents.
 -  Do not write on furniture without a padded barrier to protect the surface.
 -  Do not place furniture outside . For indoor use only .
 -  Not for commercial use. For residential use only .
 -  Stains may be removed with mild soap solution and damp cloth.
 -  Children should not climb or jump on the furniture.
-
-  Dust and pick-up spills using a clean, non-colored, lint-free cloth .