











# Assembly Instructions

**Caution : You must read this before you proceed**

## Care & Maintenance

- ⊘  ● Not for commercial use. For residential use only.
- ✓  ● Furniture may scratch floors. We recommend using furniture pads to protect your floors.
- ⊘  ● Do not put hot items directly on furniture surface.
- ⊘  ● Do not clean furniture with harsh cleansers or polish.
- ⊘  ● Do not place furniture under direct sunlight.
- ⊘  ● Do not place furniture near heating or cooling vents.
- ⊘  ● Do not write on furniture without a padded barrier to protect the surface.
- ⊘  ● Do not place furniture outside . For indoor use only.
- ⊘  ● Stains may be removed with mild soap solution and damp cloth.
- ⊘  ● Children should not climb or jump on the furniture.
- ✓  ● Dust and pick-up spills using a clean, non-colored, lint-free cloth.

Please look in Seat frame for hardware packs and legs.



Sets often ship in multiple boxes and may arrive a day or two apart.

# CHAIR



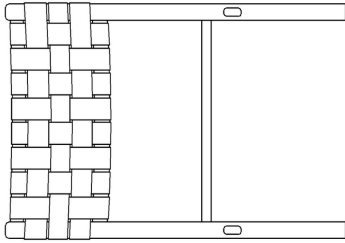
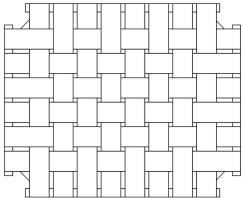
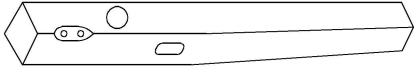

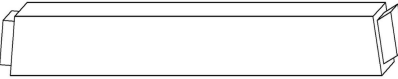

## Parts List

Label	Picture	Description	QTY
A	 A line drawing of the chair backrest, showing the woven pattern and the frame.	Chair Back	1
B	 A line drawing of the seat cushion, showing the woven pattern.	Seat Cushion	1
C	 A line drawing of the right leg, showing the shape and the attachment points.	Right Leg	1

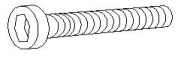
D		Left Leg	1
E		Connecting Rod	1
F		Connecting Rod	2

## Hardware

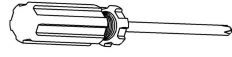
Label	Picture	Description	QTY
①		Allen Wrench (M6)	1
②		Bolt (M6x63mm)	9
③		Spring Washer (M6)	9
④		Flat Washer (M6)	9
⑤		Screw (Φ8x38mm)	7
⑥		Screwdriver (not provided)	1

## Assembly Preparation

Before Beginning Assembly:

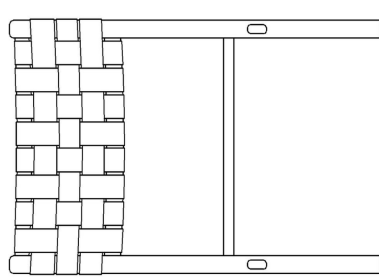

A

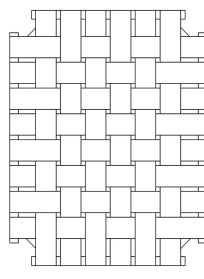

B



C



D



E

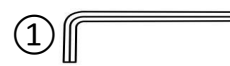

①

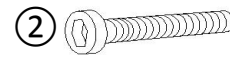

②

X 9



③

X 9



④

X 9



⑤

X 7



F



• Read instructions, cover to cover-



• Have 2 adults on hand for assembly-



• Do not assemble on flooring or carpet-



• Assemble on a clean non-marring surface (packing foam)-



• Save all packaging until finished-

## Assembly Steps

### Overview

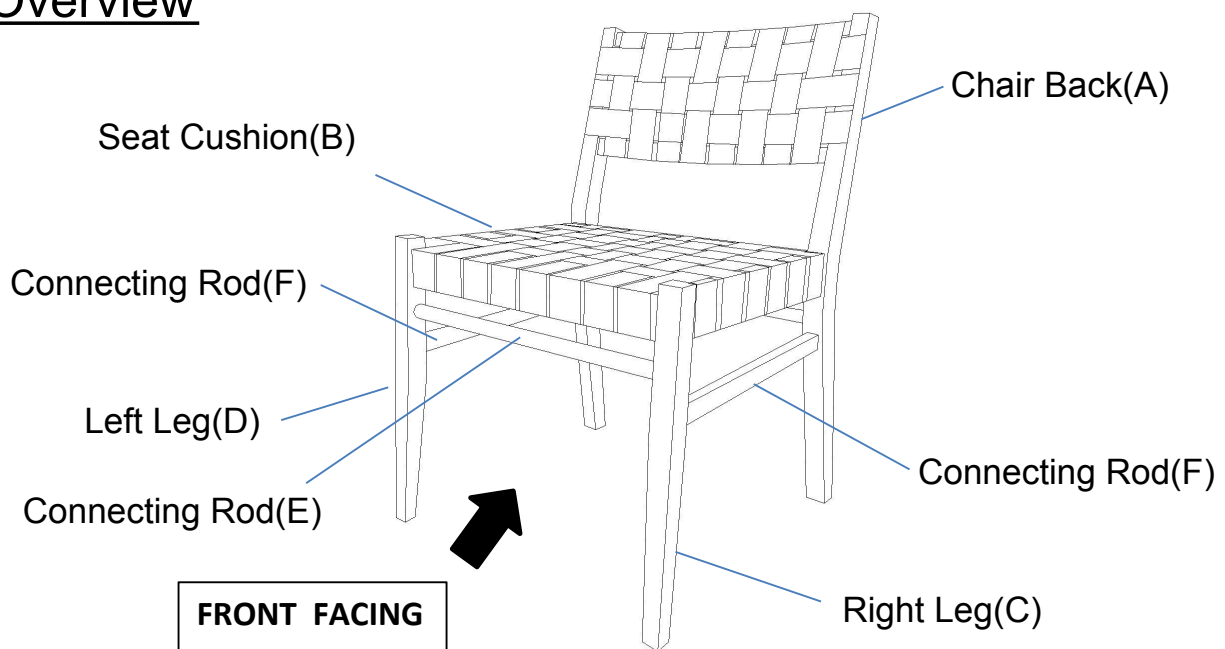

This Chair has multiple parts and may require up to some 30 minutes to assemble. To give you an overview of the chair parts, the above picture is to help you put the various parts into perspective. Please read through the instructions below to familiarise yourself with the parts and steps before assembly.

### Step 1

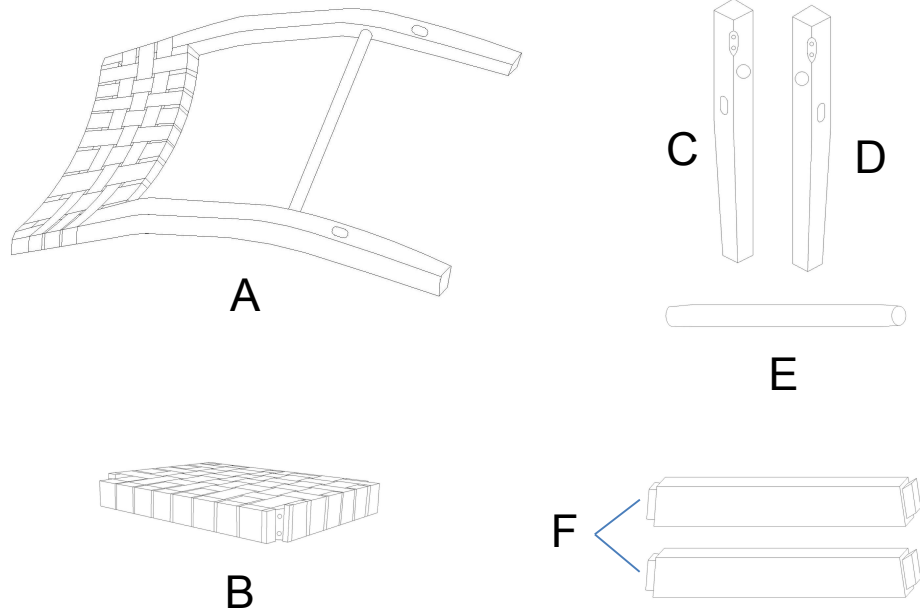

Place all Parts on a clean and flat surface.

### Step 2

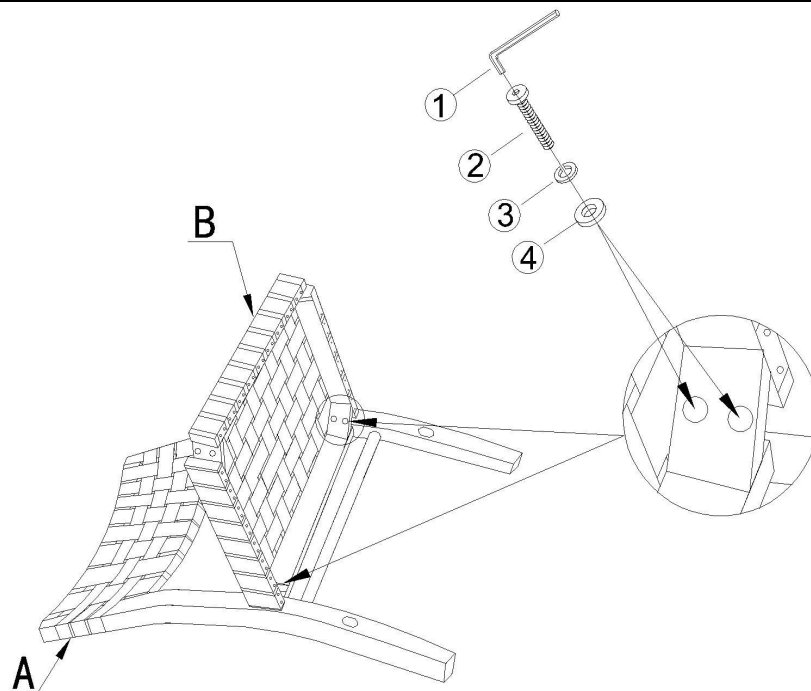

Install the Seat Cushion (B) using the Allen Wrench (①), Bolts (②), Spring Washers (③) and Flat washers (④), as pictured above.  
**Do not fully tighten the Bolts at this time.**

Step 3

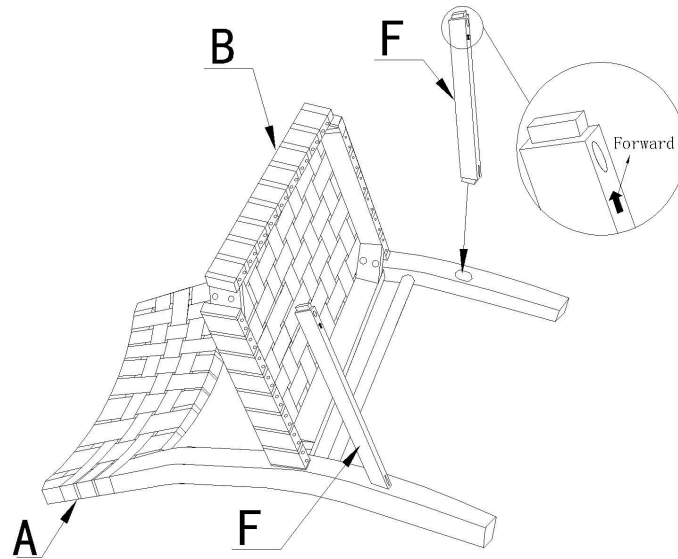

Insert the connecting rod (F) into the tenon groove of the Chair Back (A) .Note the Forward marking under the Connecting rod(F).  
**Do not fully tighten the Bolts at this time.**

Step 4

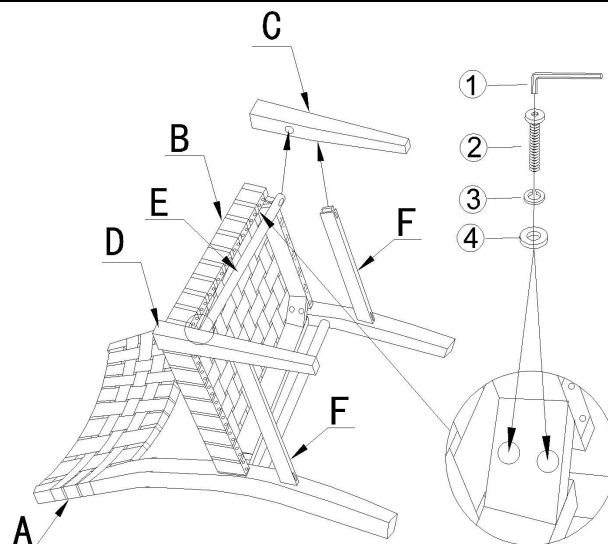

Connect the Leg (C), (D) to the connecting rods (E), (F), and then lock them with the Allen Wrench(①), Bolt (②), Spring Washer (③), and Flat Washer (④).  
**Do not fully tighten the Bolts at this time.**

## Step 5

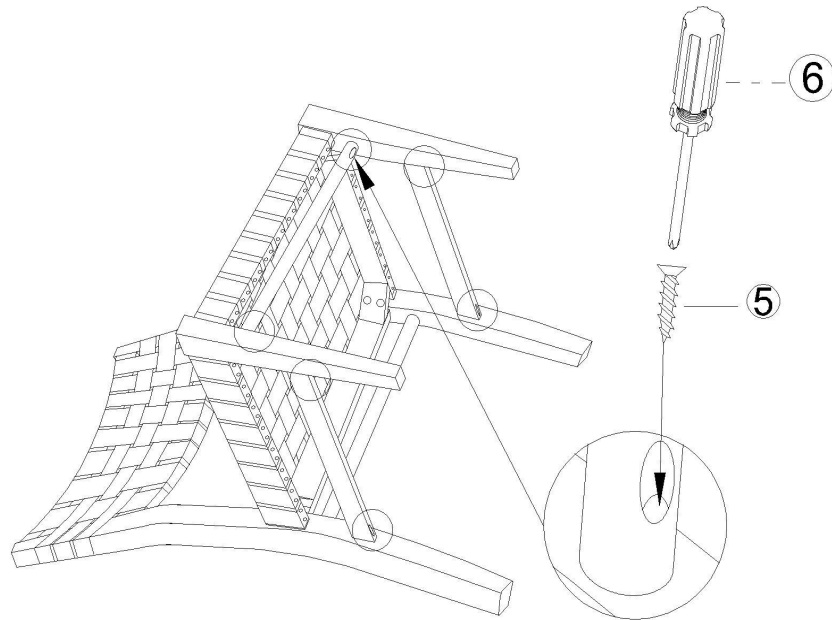

Use the Screwdriver (⑥) and Screws (⑤) to affix the Connecting rods (E), (F) as shown in the picture above. Finally, tighten all the bolts and screws sequentially.

## Step 6

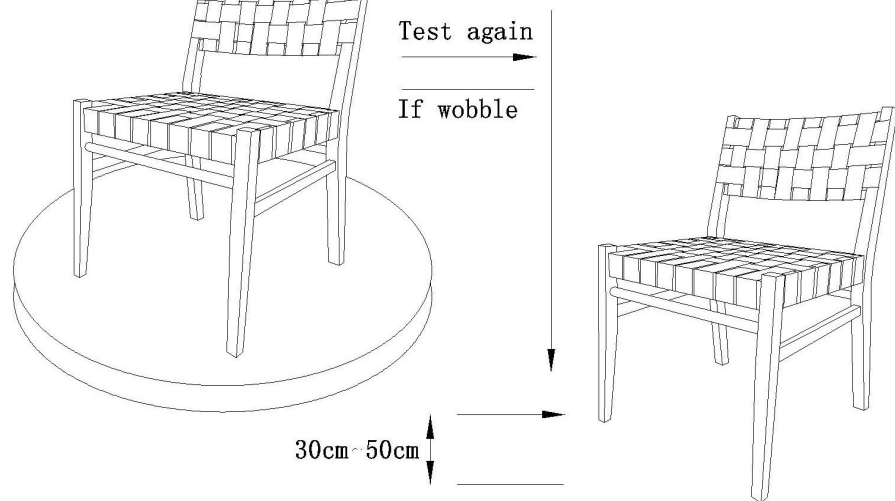

Place the Chair on a level Surface to check for wobbles.  
If it wobbles, lift the Chair some 30cm to 50cm high from the ground.  
Keep your feet and toes well away from the drop zone.  
Drop the Chair freely and vertically, with all four legs hitting the ground at the same time.  
This Drop Test will help to ensure that all Bolts and gaps reach full alignment status.  
Test again for evenness on a Level Surface.  
If no wobbles are found, proceed to tighten all the Bolts.  
When tightening the Bolts, tighten sequentially.  
Do not fully tighten any Bolt fully and then move on towards the next one. This may cause the frame to warp.  
If there are still wobbles, loosen the Bolts and execute this same drop test.

### Step 7



Your Chair is ready for use.  
This Dining Chair can only be used on a flat, level surface.