

# Assembly Instructions Plus Stacking Single Bed

## Part in Box 1

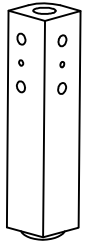

(A) Foot Post x 2

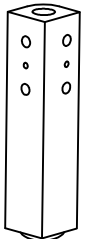

(B) Foot Post x 2

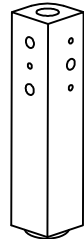

(C) Foot Post x 2

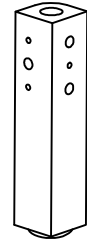

(D) Foot Post x 2

## Part in Box 2

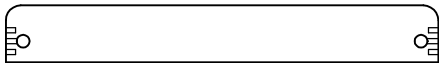

(E) Top Panel x 4

## Part in Box 3

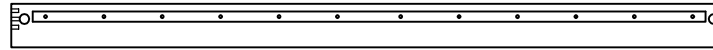

(F) Side Rail A x 2

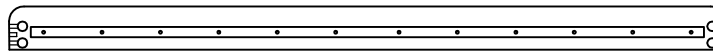

(G) Side Rail B x 2

## Part in Box 4

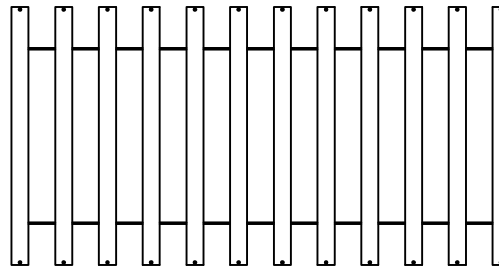

(G) Set of Slats x 2

## Hardware List

1.	M6 x 55mm Bolt		x 20
2.	Connector		x 20
3.	Wood Dowel M10 x 30mm		x 28
4.	CSK M4 x 25mm		x 48
5.	M4 Allen Key		x 1

Tool required for assembly :

- \* Allen Key ( supplied )
- \* Phillips Screwdriver ( not supplied )

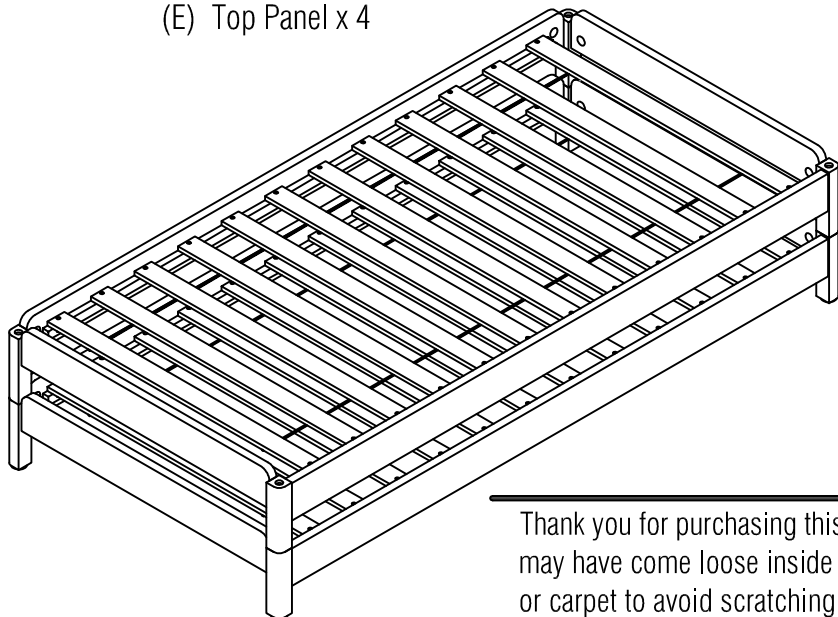

### ASSEMBLY TIPS

Remove hardware from box and sort by size to check that all hardware and parts are present before assembling. Follow instructions below in the proper sequence to ensure fast, easy and correct assembly.

### ⚠ WARNING !!

DO NOT FULLY TIGHTEN ALL BOLTS UNTIL ALL PARTS ARE IN PLACE. FAILURE TO FOLLOW THIS INSTRUCTION MAY CAUSE THE BOLTS TO BE MISALIGNED DURING THE ASSEMBLY.

NOTE : DURING ASSEMBLY , DO NOT TIGHTEN ANY SCREWS UNTIL THE COMPLETE UNIT HAS BEEN ASSEMBLED.

Thank you for purchasing this quality product. Be sure to check all packed material carefully for small parts which may have come loose inside the carton during shipment. Place all parts on a clean , smooth surface such as a rug or carpet to avoid scratching the parts. Be sure you have all the parts and hardware before you begin assembly.



# Assembly Instructions Plus Stacking Single Bed

1 Fit in the screw (1) to Foot Post.

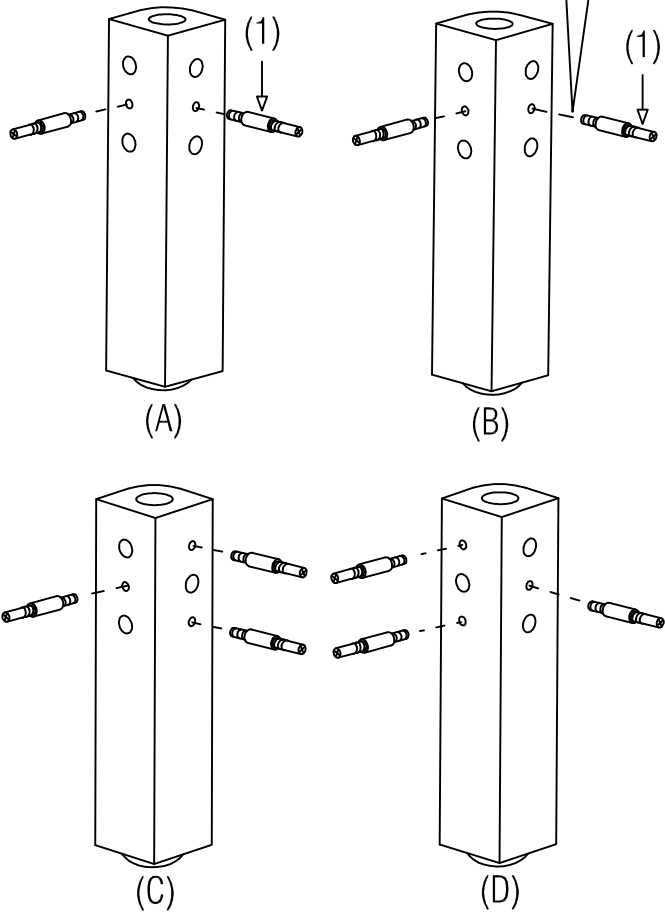
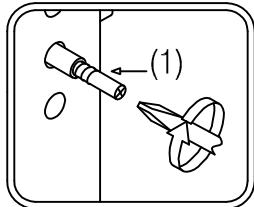
1.	M6 x 55mm Bolt		x 20
----	----------------	---	------



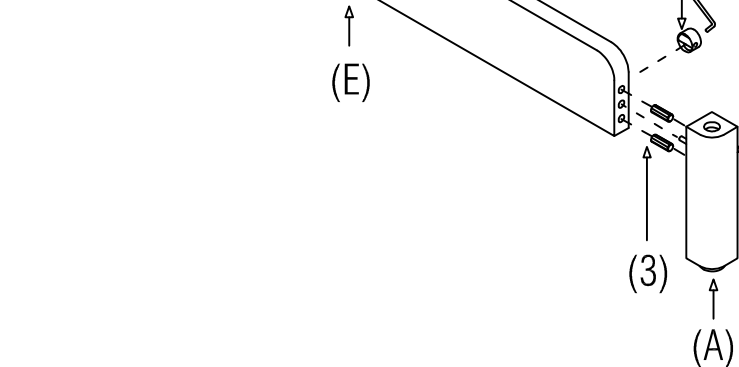
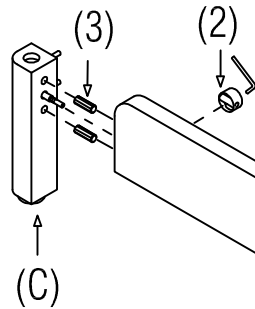

2 Assemble the Foot Post (A) and (B) to the Top Panel (E). Afterwards, tighten the Connector (2).

2.	Connector		x 4
3.	Wood Dowel M10 x 30mm		x 8



3 Assemble the Foot Post (C) and (D) to the Top Panel (E). Afterwards, tighten the Connector (2).

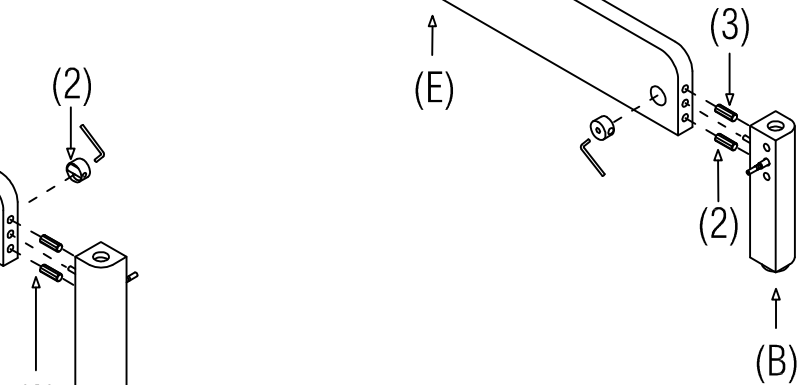
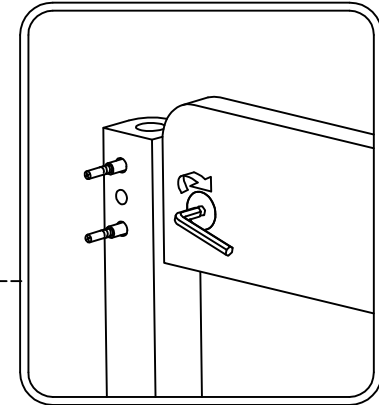
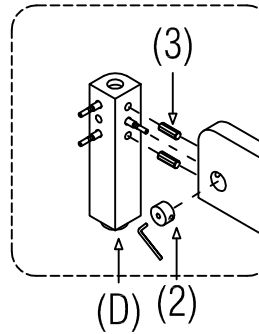

2.	Connector		x 4
3.	Wood Dowel M10 x 30mm		x 8



# Assembly Instructions Plus Stacking Single Bed

4

Attach the Side Rails (F) and (G) to the Panel Board. Afterwards, tighten the Connector (2).

2.	Connector		x 12
3.	Wood Dowel M10 x 30mm		x 12

5

Fit the Slats (H) in the place.

4.	CSK M4 x 25mm		x 48
----	------------------	---	------

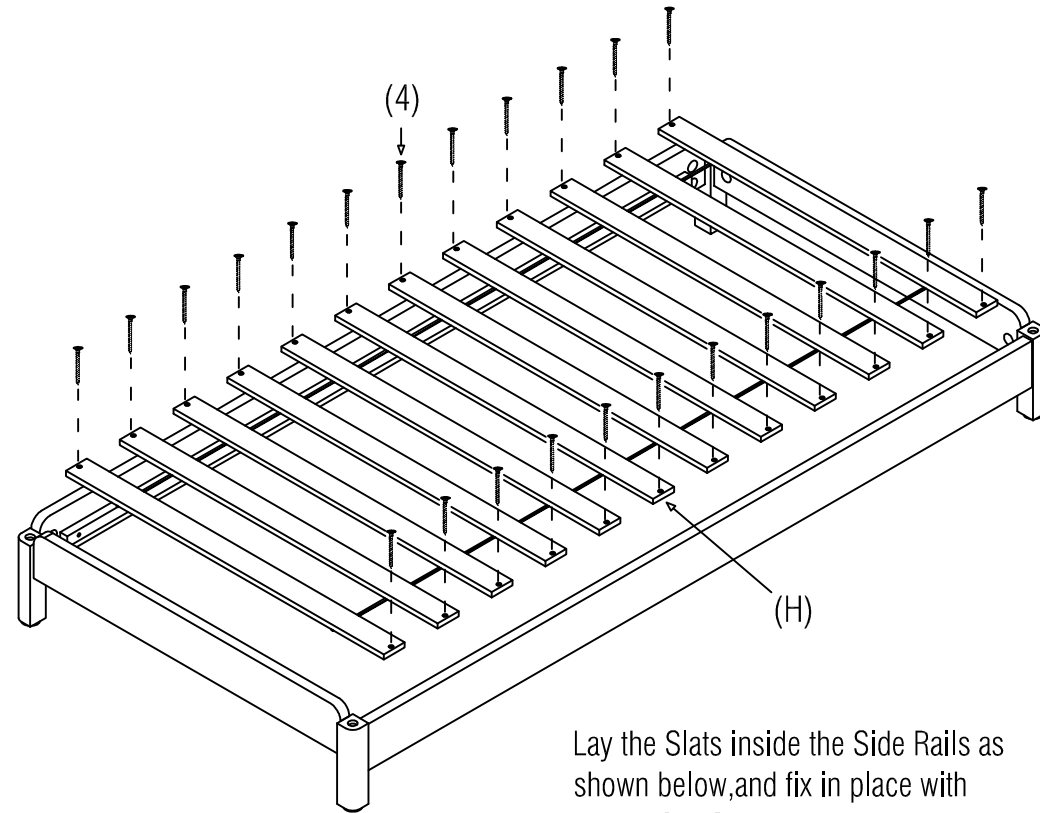
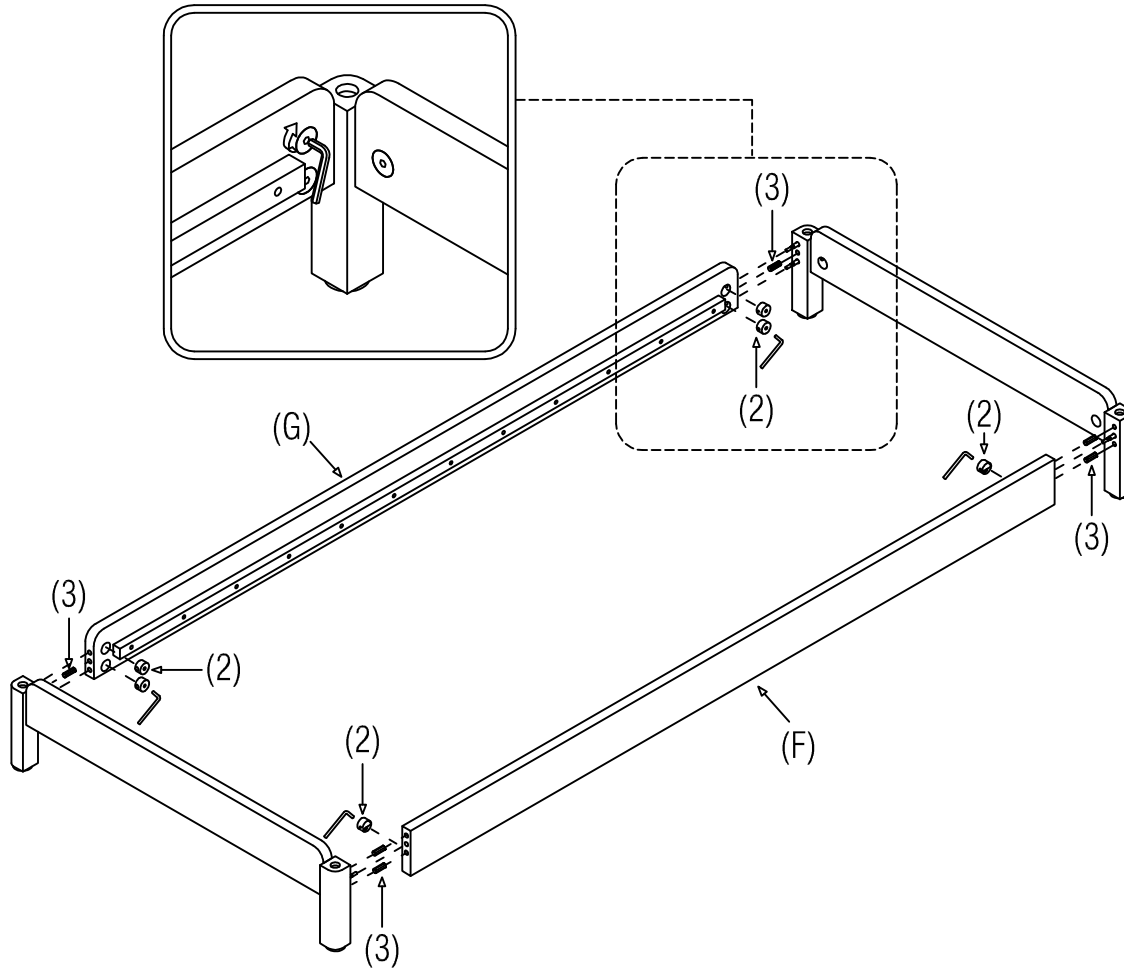

Lay the Slats inside the Side Rails as shown below, and fix in place with 25mm Csk Screws (total 24)

Assembly Instructions  
**Plus Stacking Single Bed**

**(A) 2 Single Bed Stacking**

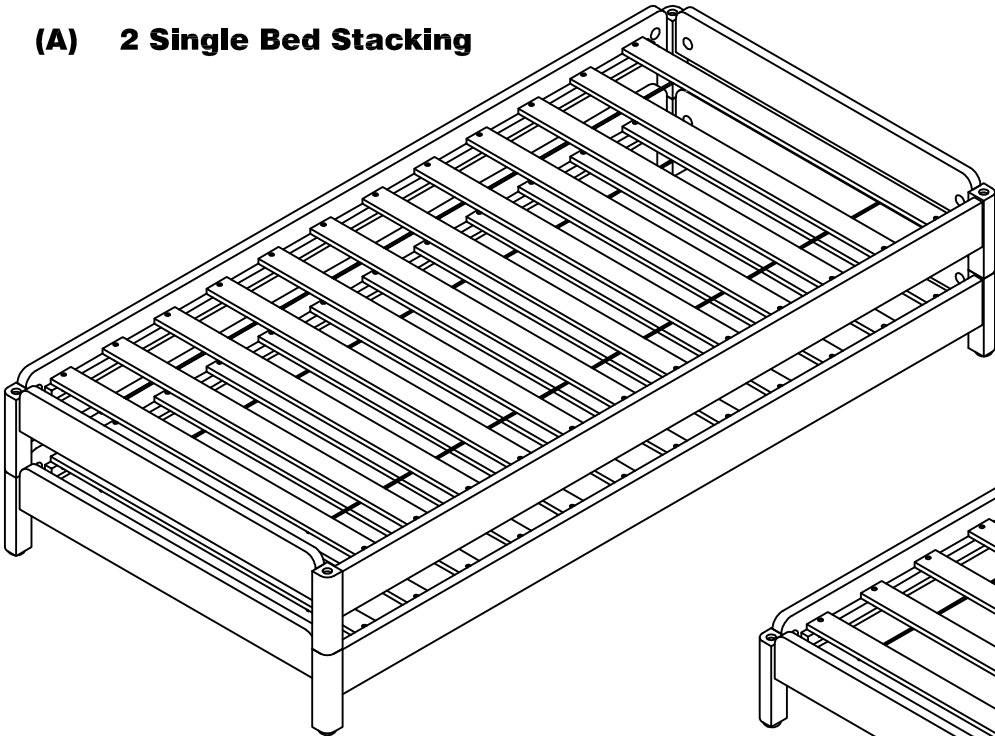

**(B) 2 Single Bed become Queen Bed**

