

---

## ASSEMBLY INSTRUCTION

# BAR STOOL



---

Please carefully unpack and identify each component before beginning assembly. Before you begin, please refer to parts list to make sure that you have all parts. Please take care when assembling the unit and always place the parts on a clean, soft surface. If you require assistance with assembly or parts, please call 888-357-7263.

---

Get social with us and discover more about our products, tips and exclusive discounts!



## PRE-ASSEMBLY PREPARATION

- **CAUTION:** Assembly will require at least 2 adults. DO NOT use power tools. Please inspect all items BEFORE assembly. If for any reason you need to return this item, please kindly return it in its original packaging.
- **WARNING!**
  1. DO NOT let any sharp objects touch or rub the surface of the product.
  2. When assembling, do not let children play around the working area.
  3. DO NOT tighten all bolts and screws completely until the entire unit has been assembled and set up.
  4. DO NOT USE if this product become damaged, and/or components are broken or missing.
- **CARE AND CLEANING:** DO NOT scratch or chip the finish. DO NOT use abrasive chemicals for cleaning. Clean with mild soap on a soft rag. Rinse and dry thoroughly.
- **MAINTENANCE:** Please periodically check all fittings and re-tighten as necessary.

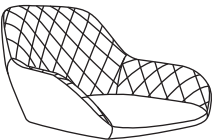
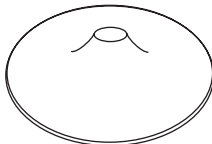
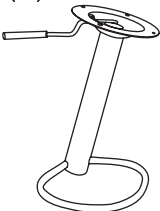
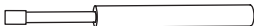
## PARTS LIST

<p>SEAT (A)</p>  <p>Qty: 2</p>	<p>BASE (B)</p>  <p>Qty: 2</p>	<p>LEG (C)</p>  <p>Qty: 2</p>	<p>GAS LIFT (D)</p>  <p>Qty: 2</p>
---	---	---	---

## HARDWARE LIST

<p>ALLEN BOLT (E) M6X16MM</p>  <p>Qty: 8</p>	<p>ALLEN WRENCH (F)</p>  <p>Qty: 2</p>		
---	---	--	--

# STEP-BY-STEP ASSEMBLY

PLEASE CAREFULLY UNPACK AND IDENTIFY EACH COMPONENT BEFORE BEGINNING ASSEMBLY. BEFORE YOU BEGIN, PLEASE REFER TO PARTS LIST TO MAKE SURE THAT YOU HAVE ALL PARTS.

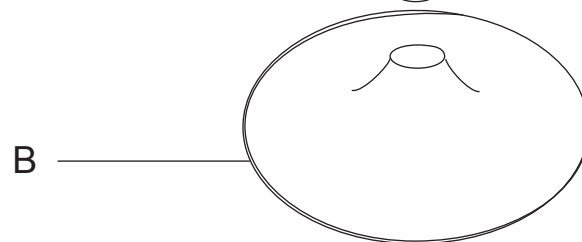
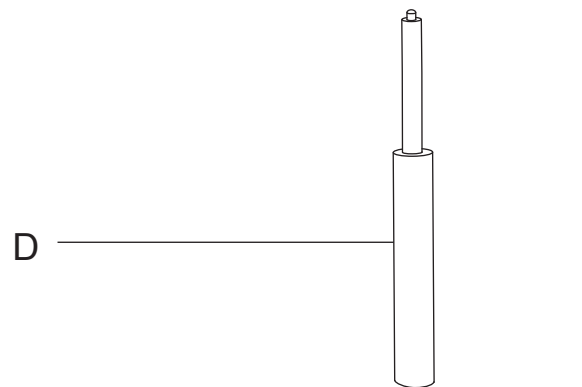
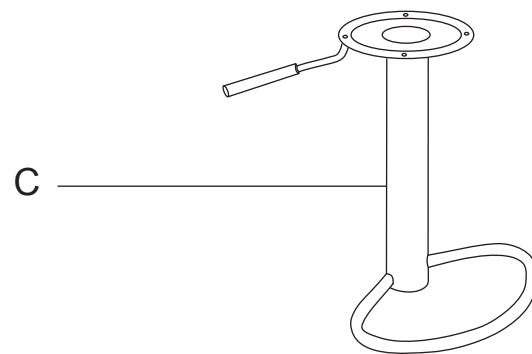
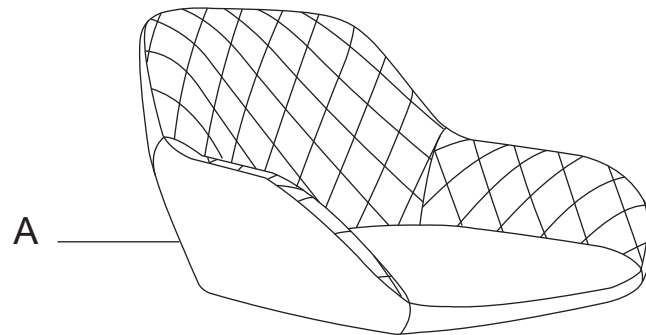

E

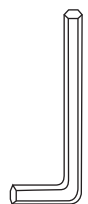

F

**STEP 1** Insert the Gas Lift (D) to the Base (B) as shown in below diagram.  
**Warning!**Please remove the plastic cap before assembly.

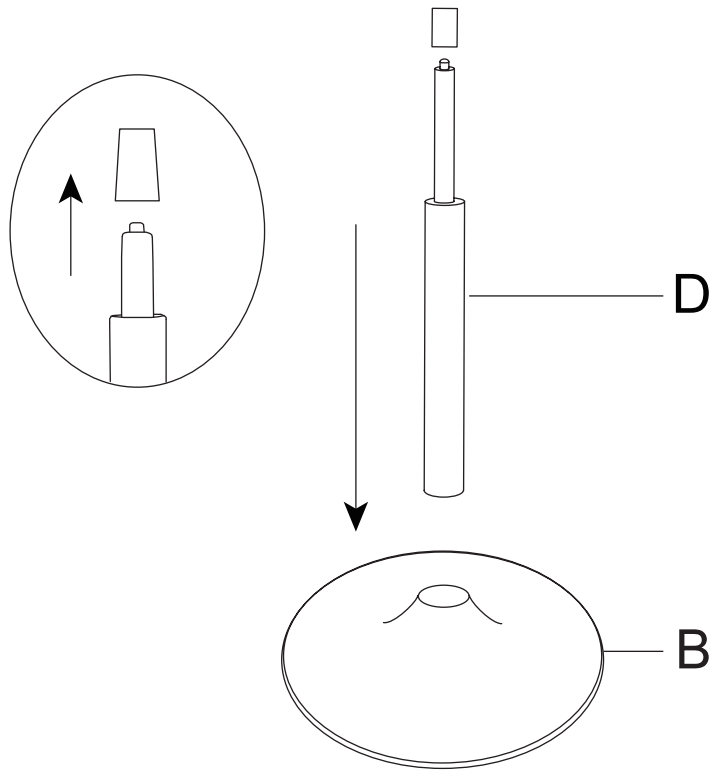

**STEP 2** Attach the Leg (C) to the Seat (A) by using Allen Bolt (E) and Allen Wrench (F) as shown in below diagram.

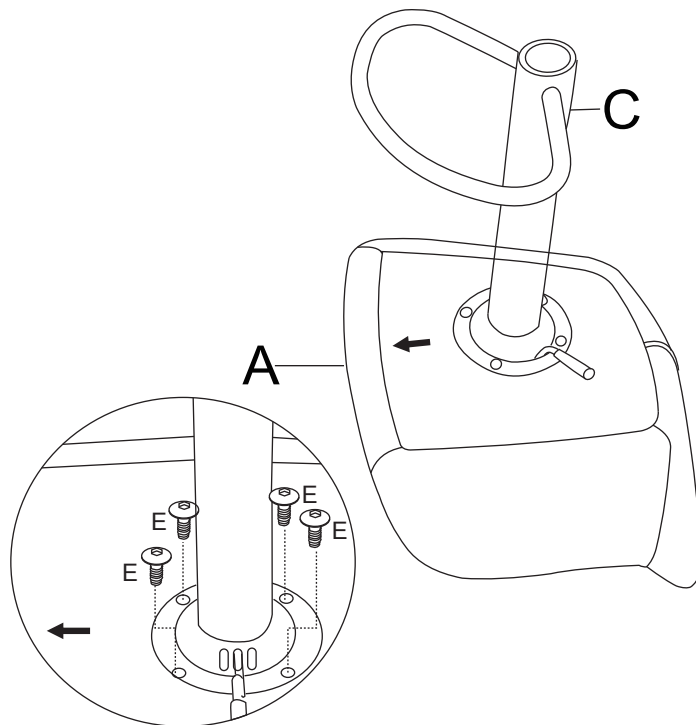

**STEP 3** Insert the Gas Lift (D) to the Leg (C) as shown in below diagram.

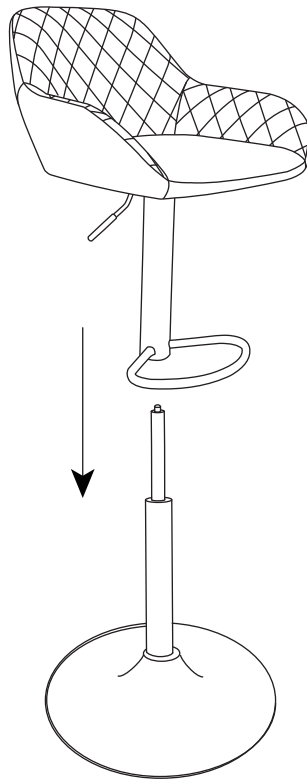

**STEP 4** A few days after initial assembly, the product may acclimate to its new environment. Please ensure all screws are still securely tightened.

