

User's Manual

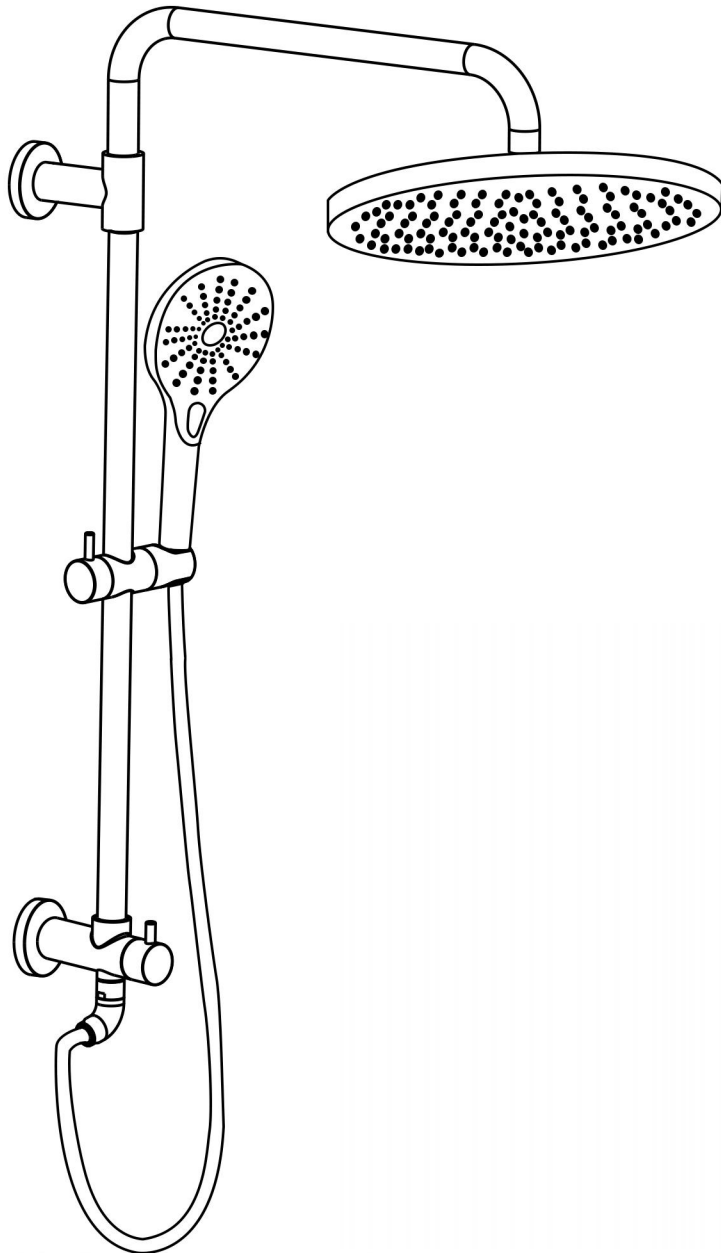



INSTALLATION INSTRUCTIONS

Installation Manual



IAPMO RESEARCH AND TESTING, INC.
5001 East Philadelphia Street, Ontario, California 91761-2816 • (909) 472-4100 Fax (909) 472-4244 • www.iapmo.org

CERTIFICATE OF LISTING

IAPMO Research and Testing, Inc. is a product certification body which tests and inspects samples taken from the supplier's stock or from the market or a combination of both to verify compliance to the requirements of applicable codes and standards. This activity is coupled with periodic surveillance of the supplier's factory and operations as well as the assessment of the supplier's Quality Assurance System. This listing is subject to the conditions set forth in the IAPMO Research and Testing, Inc. Standard for Product Certification. The listing is not a warranty, insurance or guarantee by IAPMO Research and Testing, Inc. of the product except as authorized by applicable laws and regulations.

Effective Date: August 2013 **Void After:** August 2014

Product: Plumbing Fixture Fittings **File No.:** 6737

Issued To: Kaiping Heart Cartridge Co., Ltd.
No. 28 Heilman Dony Road,
Shilong Town,
Kaiping City, GUANGDONG
China

Identification: Plumbing supply fittings complying with this Standard shall be marked with the manufacturer's recognized name, trademark, or other mark or, in the case of private labeling, the name, trademark or other mark of the customer for whom the fitting was manufactured. The marking shall be accomplished by use of a permanent mark or by placing a permanent label on the product. Markings on plumbing supply fittings shall be visible after installation.

Single-handle, single-control, and automatic compensating mixing bath and shower valves shall have identifiable temperature control settings in which the settings are indicated by words "cold", "warm", "hot", etc.), by numbers, or graphically.

Packages shall be marked with the manufacturer's name, trademark, or other mark as well as the model number or, in the case of private labeling, the name, trademark, or mark of the customer for whom the fitting was manufactured as well as the model number.





 Chairman, Product Certification Committee

 CEO, The IAPMO Group



This listing period is based upon the last date of the month indicated on the Effective Date and Void After Date shown above. Any change in material, manufacturing process, marking or design without having first obtained the approval of the Product Certification Committee, or any extension of manufacturing process, marking or design without having first obtained the approval of the Product Certification Committee, or any extension of manufacturing process, marking or design without having first obtained the approval of the Product Certification Committee, shall be considered as a change in the listing. Production of or reference to this form for advertising purposes may be made only by specific written permission of IAPMO Research and Testing, Inc. Any alteration of this certificate shall be grounds for revocation of the listing. This document shall be reproduced in its entirety.

IAPMO RESEARCH AND TESTING, INC.
5001 East Philadelphia Street, Ontario, California 91761-2816 • (909) 472-4100 Fax (909) 472-4244 • www.iapmo.org

CERTIFICATE OF LISTING

IAPMO Research and Testing, Inc. is a product certification body which tests and inspects samples taken from the supplier's stock or from the market or a combination of both to verify compliance to the requirements of applicable codes and standards. This activity is coupled with periodic surveillance of the supplier's factory and operations as well as the assessment of the supplier's Quality Assurance System. This listing is subject to the conditions set forth in the IAPMO Research and Testing, Inc. Standard for Product Certification. The listing is not a warranty, insurance or guarantee by IAPMO Research and Testing, Inc. of the product except as authorized by applicable laws and regulations.

Effective Date: October 2016 **Rev.:** 11/28/2016 **Void After:** October 2017

Product: Flexible Water Connectors **File No.:** 4955

Issued To: Tuban Jiejin Plumbing Hose & Parts Co., Ltd.
Package Industry Zone
Tuban County
Chengde 117400,
China

Identification: Manufacturer's name or trademark and UPC® certification mark. Special note on label "For use with water in exposed locations only."

Characteristics: Flexible water connectors manufactured in various sizes, lengths and metal and fittings for hot or cold water applications that consist of an inner tube, which may or may not have an outer braided cover. Connectors are to be installed for use in accessible locations only and in accordance with the manufacturer's instruction, and the latest edition of the Uniform Plumbing Code.

Products listed on this certificate have been tested by an IAPMO R&T recognized laboratory. This recognition has been granted based upon the laboratory's compliance to the applicable requirements of ISO/IEC 17025.

Products are in compliance with the following code(s):
Uniform Plumbing Code (UPC®)



 Chairman, Product Certification Committee

 CEO, The IAPMO Group



This listing period is based upon the last date of the month indicated on the Effective Date and Void After Date shown above. Any change in material, manufacturing process, marking or design without having first obtained the approval of the Product Certification Committee, or any extension of manufacturing process, marking or design without having first obtained the approval of the Product Certification Committee, or any extension of manufacturing process, marking or design without having first obtained the approval of the Product Certification Committee, shall be considered as a change in the listing. Production of or reference to this form for advertising purposes may be made only by specific written permission of IAPMO Research and Testing, Inc. Any alteration of this certificate shall be grounds for revocation of the listing. This document shall be reproduced in its entirety.

IAPMO RESEARCH AND TESTING, INC.
5001 East Philadelphia Street, Ontario, California 91761-2816 • USA • 909-472-4100 • 909-472-4244 • www.iapmo.org





CERTIFICATE OF LISTING

IAPMO Research and Testing, Inc. is a product certification body which tests and inspects samples taken from the supplier's stock or from the market or a combination of both to verify compliance to the requirements of applicable codes and standards. This activity is coupled with periodic surveillance of the supplier's factory and operations as well as the assessment of the supplier's Quality Assurance System. This listing is subject to the conditions set forth in the IAPMO Research and Testing, Inc. Standard for Product Certification. The listing is not a warranty, insurance or guarantee by IAPMO Research and Testing, Inc. of the product except as authorized by applicable laws and regulations.

Effective Date: November 2016 **Rev.:** 3/1/2017 **Void After:** November 2017

Product: Plumbing Fixture Fittings **File No.:** 4528

Issued To: Heppel, Inc.
171 Mattatuck Heights
Haterbury, CT 06705

Identification: Each fitting component shall bear permanent legible markings to identify the manufacturer. This marking shall be the trade name, trademark, or other mark known to identify the manufacturer. The product shall also bear all other markings required by the standard. The marking shall be located where it can be readily seen after installation is complete. The product or packaging shall also bear the UPC® certification mark.

Characteristics: Plumbing fixture fitting components to be installed in accordance with the manufacturer's instructions and the requirements of the latest edition of the Uniform Plumbing Code.

Products listed on this certificate have been tested by an IAPMO R&T recognized laboratory. This recognition has been granted based upon the laboratory's compliance to the applicable requirements of ISO/IEC 17025.

Products are in compliance with the following code(s):
Uniform Plumbing Code (UPC®)
National Plumbing Code of Canada

 Chairman, Product Certification Committee

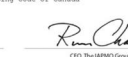
 CEO, The IAPMO Group







This listing period is based upon the last date of the month indicated on the Effective Date and Void After Date shown above. Any change in material, manufacturing process, marking or design without having first obtained the approval of the Product Certification Committee, or any extension of manufacturing process, marking or design without having first obtained the approval of the Product Certification Committee, or any extension of manufacturing process, marking or design without having first obtained the approval of the Product Certification Committee, shall be considered as a change in the listing. Production of or reference to this form for advertising purposes may be made only by specific written permission of IAPMO Research and Testing, Inc. Any alteration of this certificate shall be grounds for revocation of the listing. This document shall be reproduced in its entirety.

BEFORE INSTALLATION

► Installation Environment

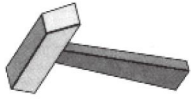
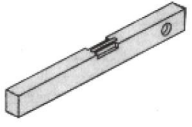
1. Before installation, confirm whether the inlet pipe and angle valve are correct. Make sure that the installation is completed, and the water has been flushed to ensure that there are no impurities in the water inlet pipe;
2. Water inlet pressure requirements: $5\text{bar} \geq \text{inlet pressure} \geq 0.5\text{bar}$, it is recommended to install a pressure reducing valve if it is greater than 0.05MPa ;
3. When installing and using the faucet, please use normal torque to prevent the handle from breaking.
4. If the customer goes out for a long time or does not use the faucet for a long time, please close the faucet valve and turn on the faucet switch to release the pressure and water in the faucet.

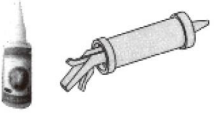
► Installation Aids

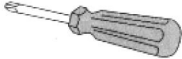
 Hammer	 Spirit level	 Adjustable wrench
 Glue (do not use glue containing acetic acid)	 Impact drill	 Screwdriver

► Parts List

NO.	Item	Qty
1	Water knockout drum	1
2	Slider	1
3	Top shower tube	1
4	Curved foot cover	2
5	Water inlet joint	1
6	Holder	1
7	Screw packet	1

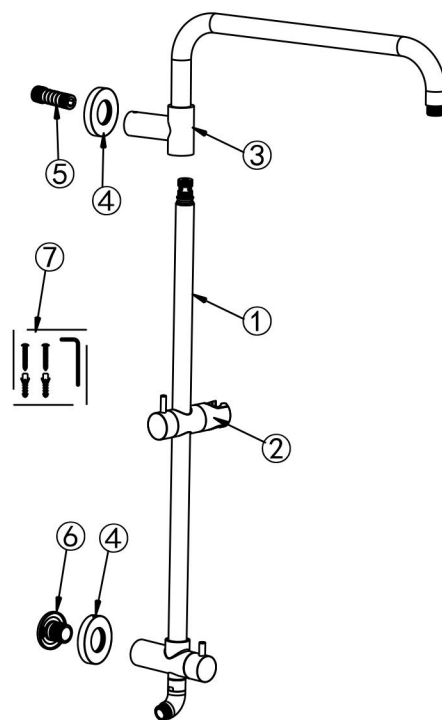

Check accessories

Standard List of Accessories:

When you open the product packaging, please check whether the objects in it are consistent with the main body and accessories you purchased. If there is any inconsistency, please contact our company or our distributor.

Note: 1. Accessories are subject to change without prior notice if the change does not affect usage;

2. The appearance of the product is subject to the physical objects you receive, and the schematic diagram is only for reference.

INSTALLATION STEPS

This product has been inspected and debugged by the factory to the best condition. Please do not disassemble and assemble it yourself.



Before installing the faucet, please be sure to remove sundries and sludge from the water pipe to prevent sundries from blocking the faucet.

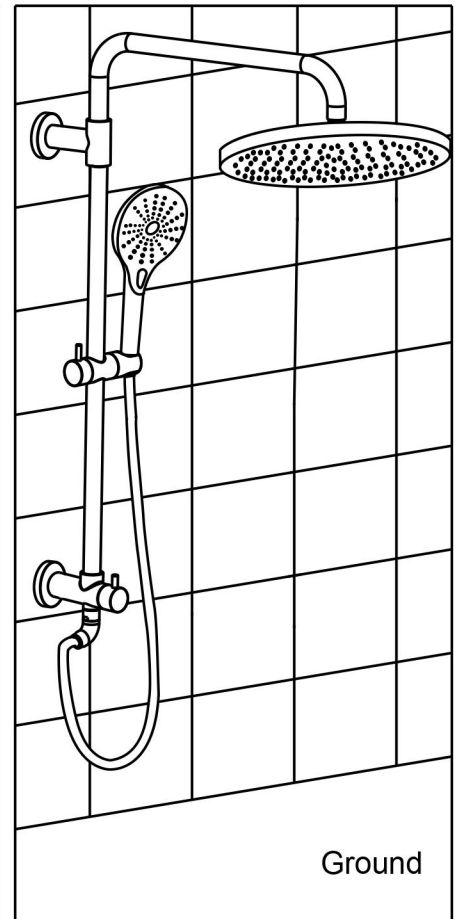
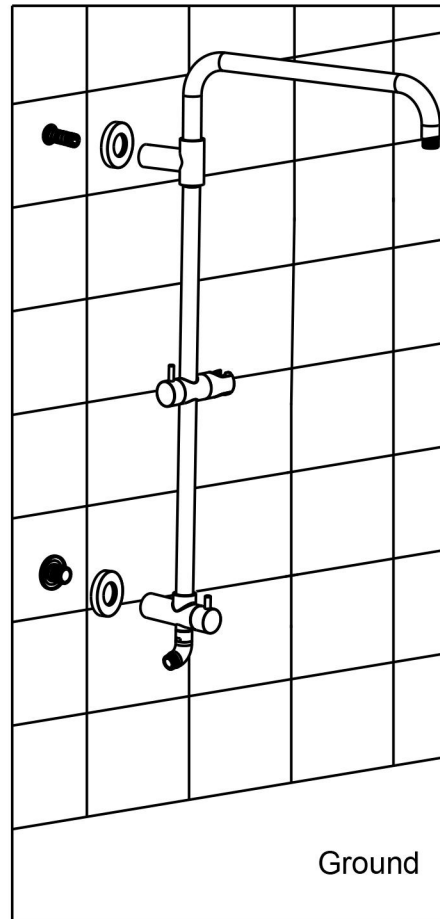
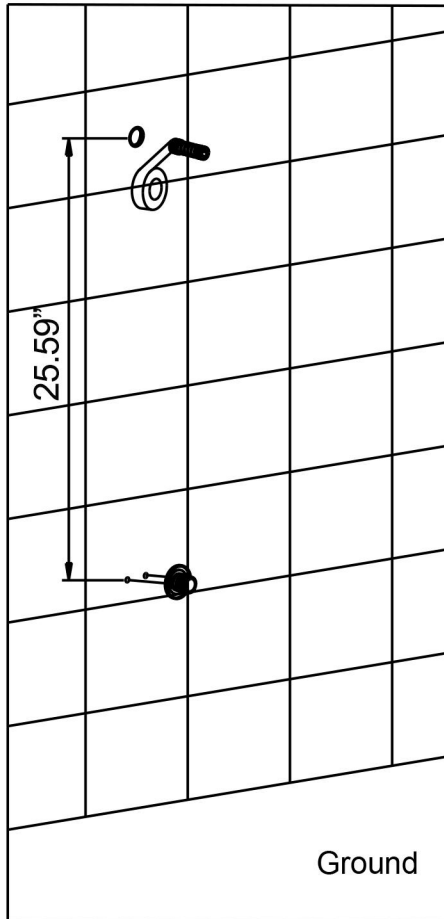
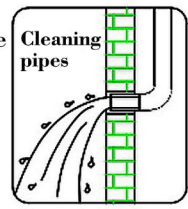

1. Wrap water inlet joint with the raw material tape and connect it with the water pipe embedded in the wall.
2. Attach the decorative cover to water inlet joint on the wall.
3. Measure the mounting position of the fixing seat according to the actual size of the product. After making the mark, drill a hole on the wall and punch the self-tapping rubber particles into the hole, then use the self-tapping screw to fix the fixing seat on the wall, and then set it firmly on the decorative cover.
4. Insert the water knockout drum into the top shower pipe, adjust the position it with a pole into the fixing seat on the wall, adjust the position and tighten it with a hexagonal wrench. If the position is slightly misaligned when the product is installed, the eccentric joint and fixing seat can be adjusted appropriately. and tighten it with a hexagonal wrench, and then connect it with the water inlet connector, tighten it with a hexagonal wrench, then insert the fixing seat on water knockout drum to the fixing seat on the wall, adjust the position and tighten.

INSTALLATION STEPS

► Test method

1. Turn the faucet handle to the closed position, open the water inlet valve, and check whether there is any leakage at all water inlet ports.
2. Open the faucet handle to the maximum, and open the water inlet valve to check whether there is leakage at the water outlet and the sprinkler connection port.
3. Operate the reversing valve several times to check the shower water condition and whether there is any leakage outside the connection.
4. If the water pressure is lower than 0.05M Pa (it is possible that the faucet drips while the shower sprinkles water, or the faucet reversing valve does not work), a booster pump should be installed in the pipeline.

INSTALLATION DIMENSION

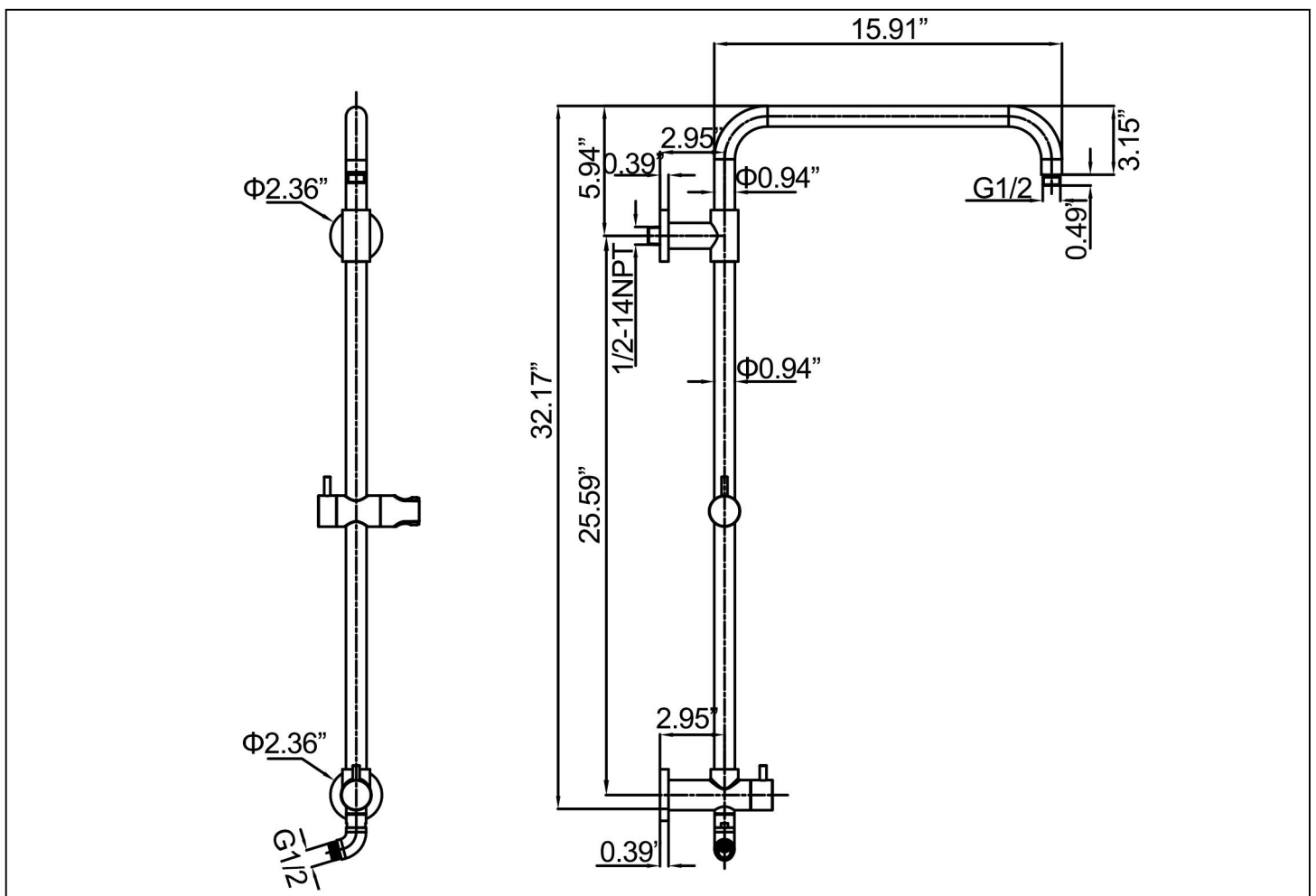

CLEANING CARE

In order to keep the appearance of faucet clean, bright and good performance, please take care of the faucet as follows;

1. Rinse with water only and dry with soft cotton cloth;
2. Use mild liquid and colorless glass cleaner to remove surface dirt and scale film, or use polish without abrasive effect;
3. Do not use abrasive detergent, polish, emery cloth, paper towel or scraper, etc.;
4. Do not use acid cleaner, or cleaner and soap with insoluble gran etc.;
5. In the process of use, mud may accumulate in the bubbler and make the water flow show, The bubbler can be unscrewed, rinsed with water, and then installed back in place.



Please feel free to contact us if you have any questions. We will help to solve the issue together with you. OUR EMAIL: services@rbrohant.com



Service Contact:
+1(801) 800-9309
services@rbrohant.com

Made in China