

WIRE CONNECTION DIAGRAM

Wires met safety standards are recommended to connect the supply circuit.

CAUTION: Risk of fire

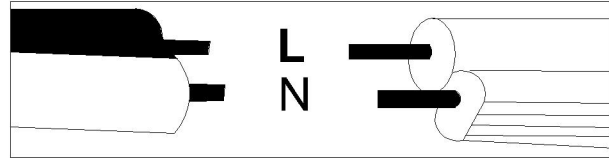

CANOPY INSTALLATION INSTRUCTIONS

Please read all instructions carefully. Before you proceed to install, make sure that the power supply is turned off and remains off until installation is complete.

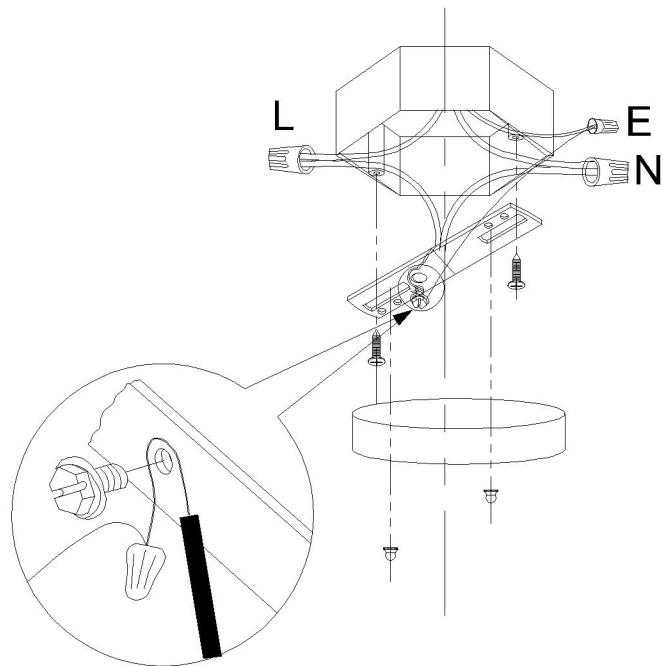

Light Bulb (Not included)

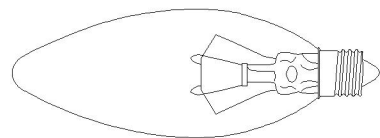

E12

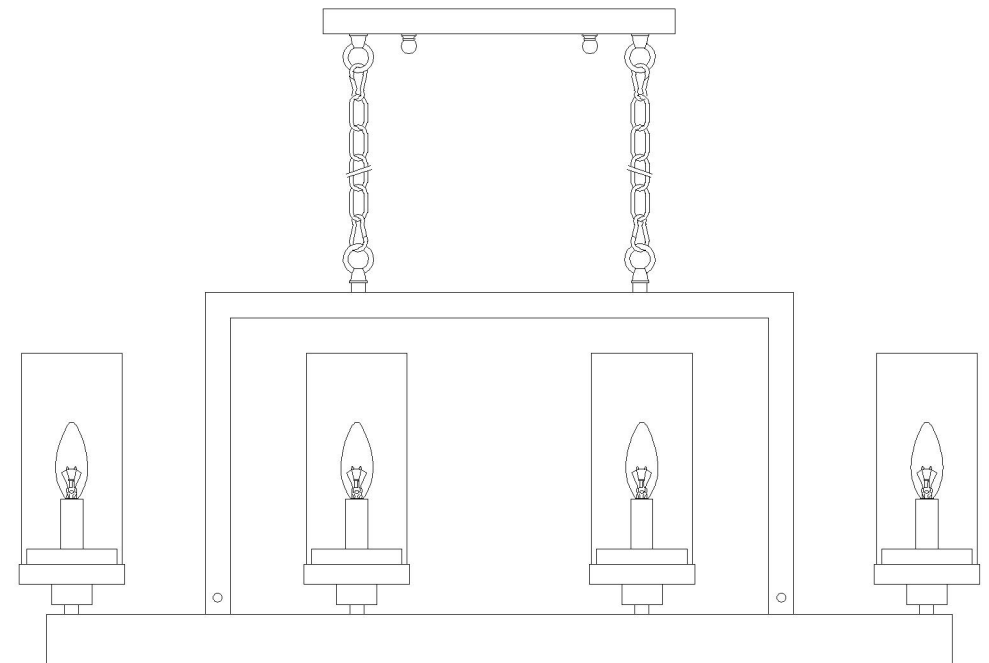





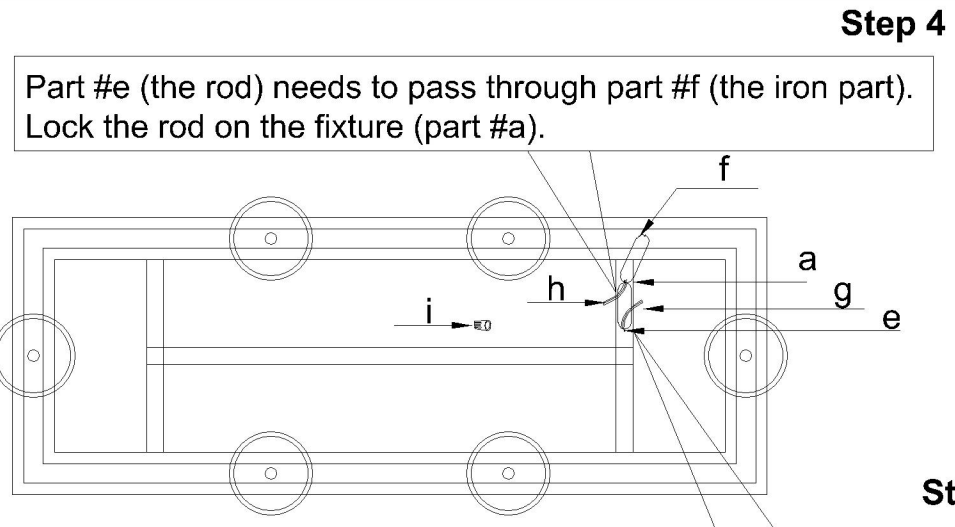
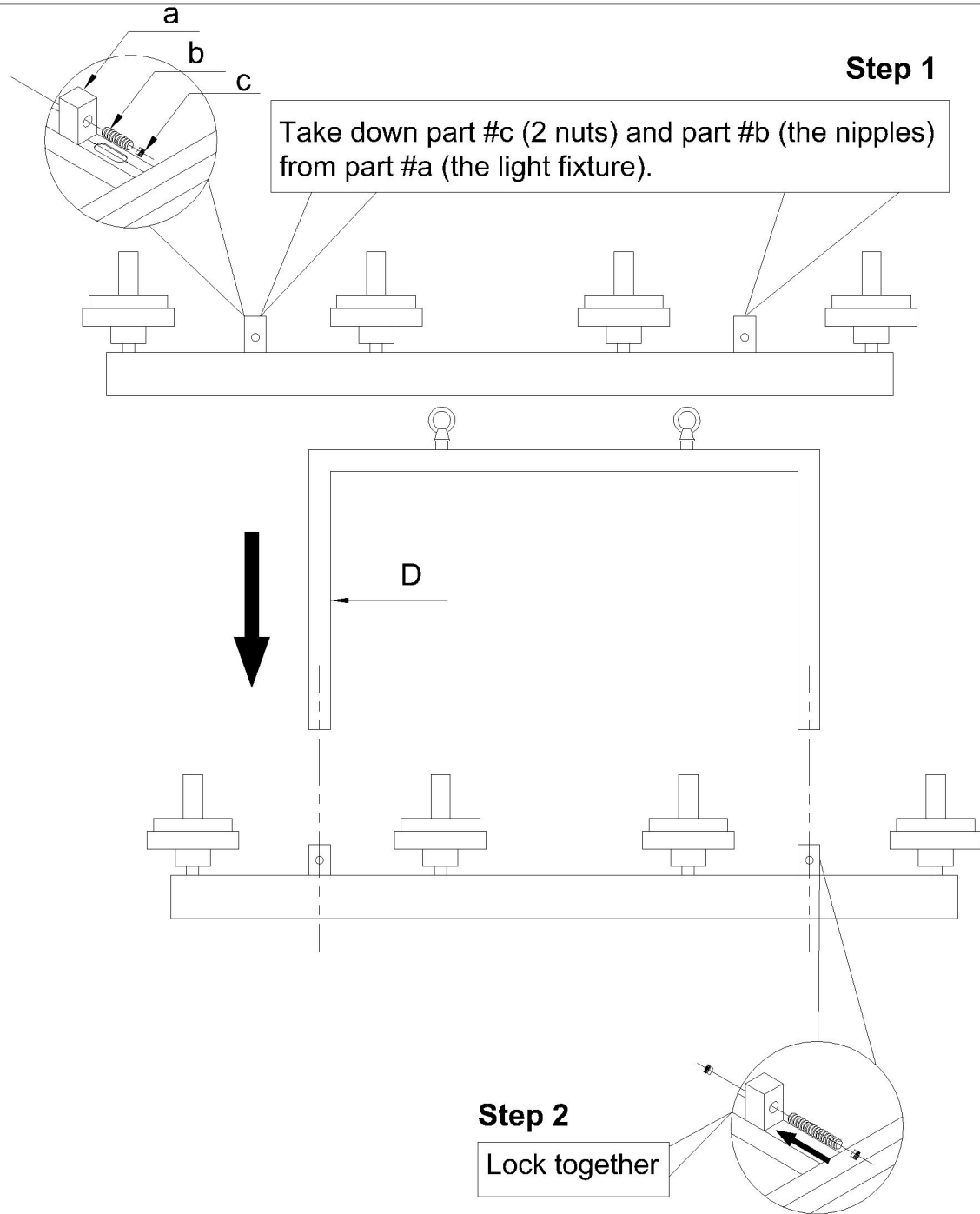

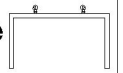

(Rated 110-130V/60Hz, bulb 40W-60W maximum.)

Assembly and Installation Steps

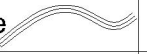

- 3A. Remove part #e (the rod) and part #f (the iron part).
- 3B. Pull the black main wire (part #g) outwards. Keep the wire to the length that you need. Cut the rest using a scissor.
- 3C. Pull the black main wire (part #h) outwards. Keep the wire to the length that you need. Cut the rest using a scissor.
- 3D. Separate the black main wire (part #g) into 2 wires. Separate the main wire (part #h) into 2 wires.
- 3E. Connect the black wire (part #g) with writings from the light fixture to the wire with writings (part #h). Screw the wiring cap into the wire. Cover the wiring cap using the insulated rubber tape.
- 3F. Connect the black wire with no writing (part #g) from the light fixture to the wire with no writing (part #h). Screw the wiring cap into the wire. Cover the wiring cap using the insulated rubber tape.
- 3G. The bare wire is the ground wire. Connect one end to the ceiling plate, and connect the other end to the ground in the ceiling junction box.

Part Name	Quantity	Part Name	Quantity	Part Name	Quantity
a: light fixture 	2 PCS	d: lamp frame 	1 PCS	g: wire 	1 PCS
b: nipple 	2 PCS	e: rod 	2 PCS	h: wire 	1 PCS
c: nut 	2 PCS	f: iron part 	1 PCS	i: iron part 	2 PCS

Assembly and Installation Steps

Step 6

6A. Lock the crossbar to the junction box of the ceiling by using 2 pcs of 5/32 screws in the accessories bag.

6B. Connect the wires. The hot/positive (+) wire is the one which has writing on it. The negative (-) wire is the one which has no writing.

Step 7

There are 2 screws and 2 nuts in the plastic bag. Hang the lamp to the ceiling by attaching the screws to the nuts.

Step 5

Attach the collar loop to the buckle.

Step 8

Install 6 E12 bulbs (Not included).

Step 9

Put the glass shade on the metal plate.

Warm tips

If you find the candlestick is not up straight, please adjust it by hand by bending it to opposite direction.

Please note: The parts in this table are completely unassembled, for illustrative purpose. In the actual product that you receive, some parts are assembled and attached together.

