

WOOD BED

ASSEMBLY INSTRUCTION

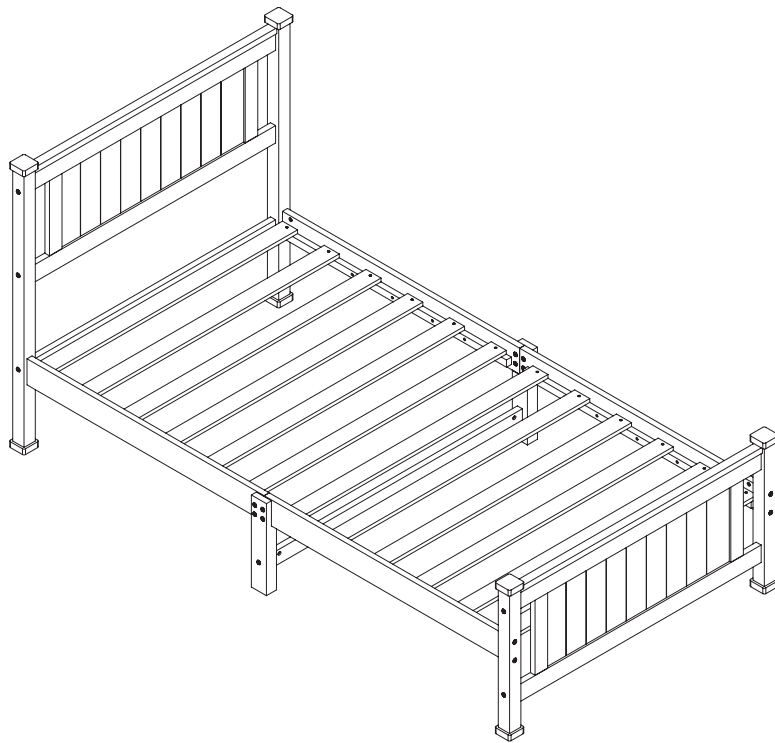

RETURN & WARRANTY

Thank you for choosing our product!

We would like to take this opportunity to thank you for choosing product.

We hope that you are completely satisfied with your purchase, and enjoy it for years to come.

Your satisfaction is our highest pursuit.

Return Policy

Believes you will absolutely love your wood bed, but if for some reason you want to return the product, please contact us directly before you decide to return your product to the retailer. Our Customer Service organization can answer most concerns and can assist you with any questions you may have about your new product.

The item must be returned in good condition, in original box, with all original proof of purchase, parts and accessories, within the time frame specified by the retailer it was purchased from.

Warranty

Warrants this product to be free from defects in material and workmanship agrees to remedy any such defect. This warranty covers one year from the date of original purchase. This is solely limited to be repair or replacement of defective parts and no assembly labor is included.

This warranty does not apply to any product which has been improperly assembled, subjected to misuse or abuse or which has been altered or repaired in anyway.

Components repaired or replaced warranted through the remainder of the original warranty period only. The defective components will be repaired or replaced without charge, subject to the terms and conditions described above.

BEFORE STARTING

Before Using Product



- Read each step carefully before starting. It is very important that each step is performed in the correct order. If these steps are not followed in sequence, assembly difficulties will occur.



- Make sure all parts are included. Most board parts are labeled or stamped on the raw edge.

- Have the following tools.



- Recommended # of people needed for assembly: 2 (however it is always better to have an extra hand). Estimated assembly time is 2.5hours.



- Work in a spacious area and near where the unit will be used preferably on a carpet, or use a piece of the cardboard packaging to protect your floor and product.





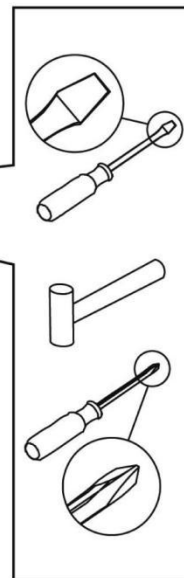



- For a smooth assembly process, we suggest you keep a lite tightness for all the screws during assembly. After the whole product is assembled, firmly tighten all the screws.

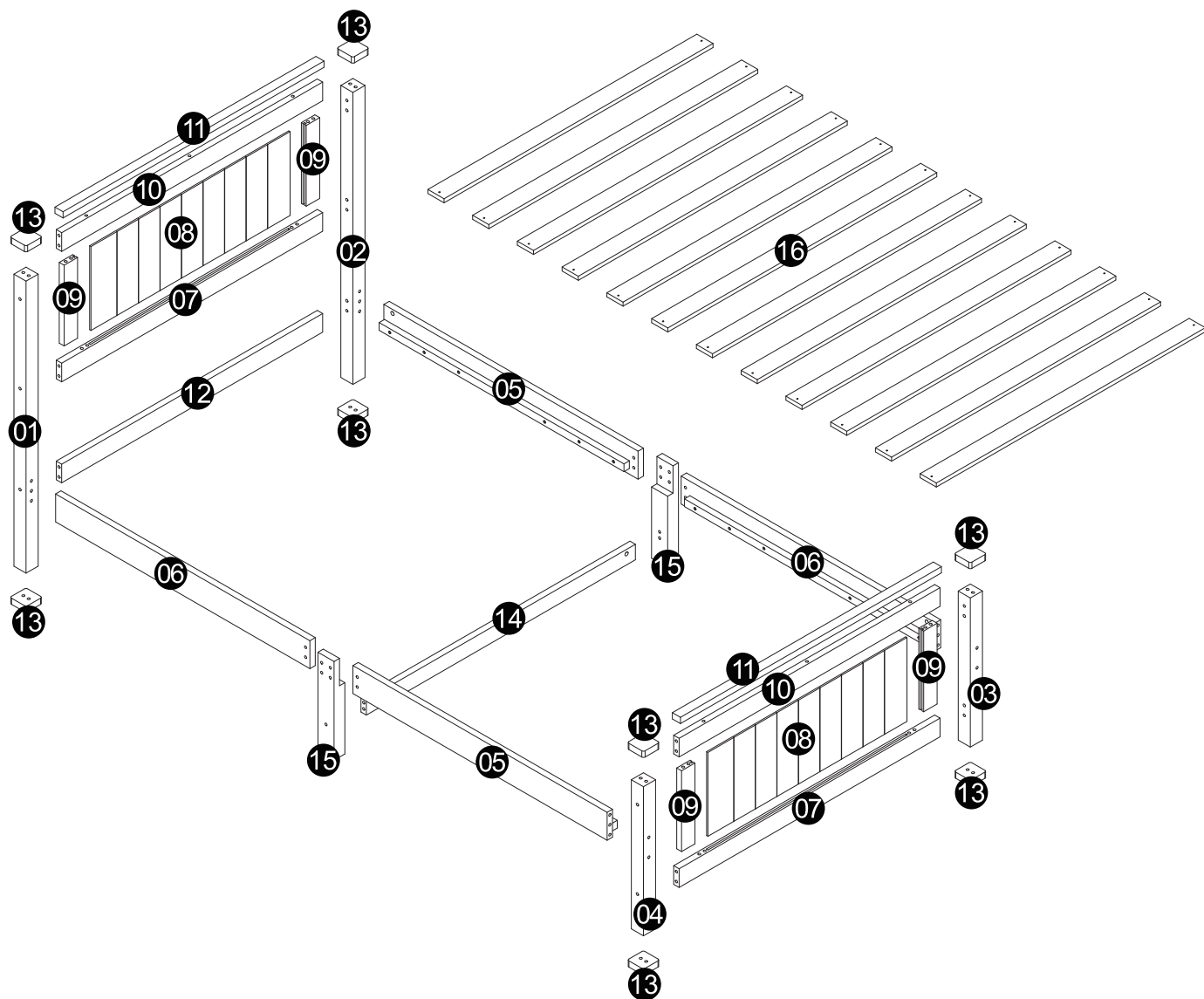

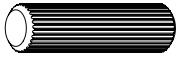
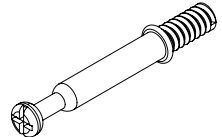
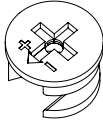
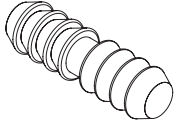
WARNING:

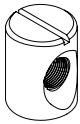
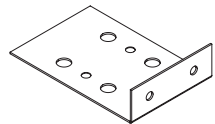
- Do not allow children to climb on unit
- Serious or fatal crushing injuries can occur from furniture tip-over. To prevent this furniture from tipping over, it must be permanently fixed to the wall. Fixing devices for the wall are not included since different wall materials require different types of fixing devices. Use fixing devices suitable for the walls in your home. For advice on suitable fixing systems, contact your local specialized dealer.
- Avoid sharp objects or corrosive chemicals to prevent damage to the product
- During assembly, keep parts and packaging materials away from children and pets as there could be potential injury and choking hazards.

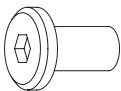
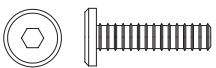

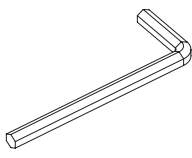
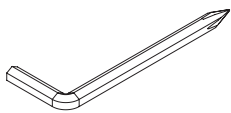
| | | | | |
|--|---|---|--|---|
| <p>A x32</p>  <p>Φ 8x30</p> | <p>B x6</p>  | <p>C x6</p>  | <p>D x16</p>  | <p>E x20</p>  <p>M6x85</p> |
| <p>F x20</p>  | <p>G x2</p>  | <p>H x8</p>  <p>Φ 3.5x16</p> | <p>J x8</p>  | <p>K x8</p>  <p>M6x30</p> |
| <p>L x24</p>  <p>Φ 4x30</p> | <p>M x1</p>  | <p>N x1</p>  | | |

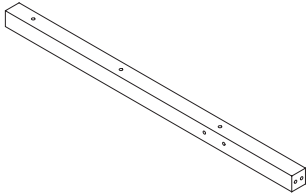
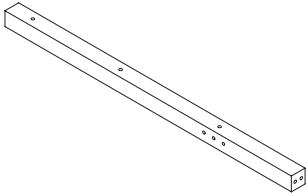
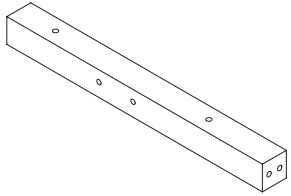
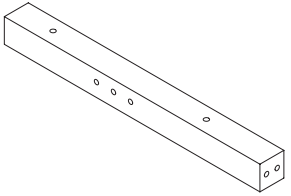
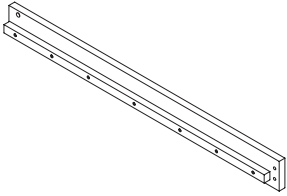
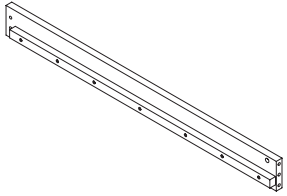
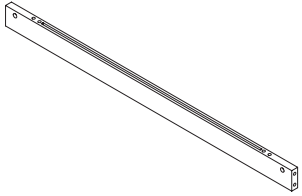
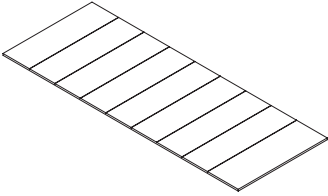
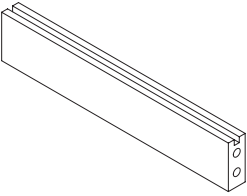
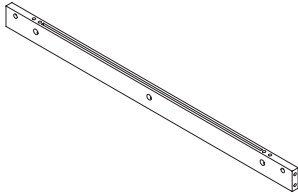
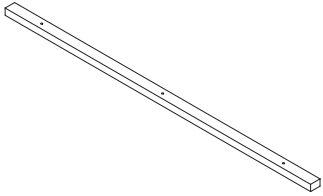
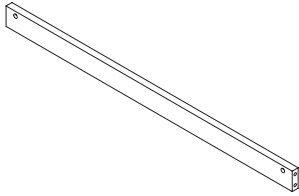
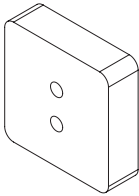
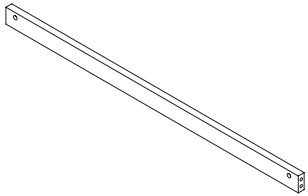
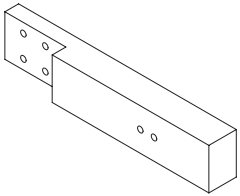
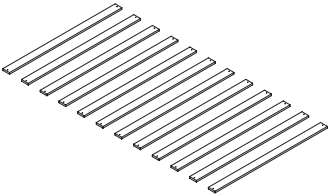
| | | | |
|--|--|--|--|
| <p>01 1pcs</p>  <p>940x45x45mm</p> | <p>02 1pcs</p>  <p>940x45x45mm</p> | <p>03 1pcs</p>  <p>480x45x45mm</p> | <p>04 1pcs</p>  <p>480x45x45mm</p> |
| <p>05 2pcs</p>  <p>945x90x18mm</p> | <p>06 2pcs</p>  <p>945x90x18mm</p> | <p>07 2pcs</p>  <p>970x60x18mm</p> | <p>08 2pcs</p>  <p>740x270x5mm</p> |
| <p>09 4pcs</p>  <p>260x50x18mm</p> | <p>10 2pcs</p>  <p>970x60x18mm</p> | <p>11 2pcs</p>  <p>970x30x20mm</p> | <p>12 1pcs</p>  <p>970x60x18mm</p> |
| <p>13 8pcs</p>  <p>60x60x20mm</p> | <p>14 1pcs</p>  <p>1000x50x18mm</p> | <p>15 2pcs</p>  <p>318x60x40mm</p> | <p>16 1pcs</p>  <p>1000x60x13mm</p> |

Step 2

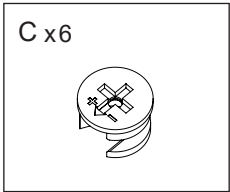
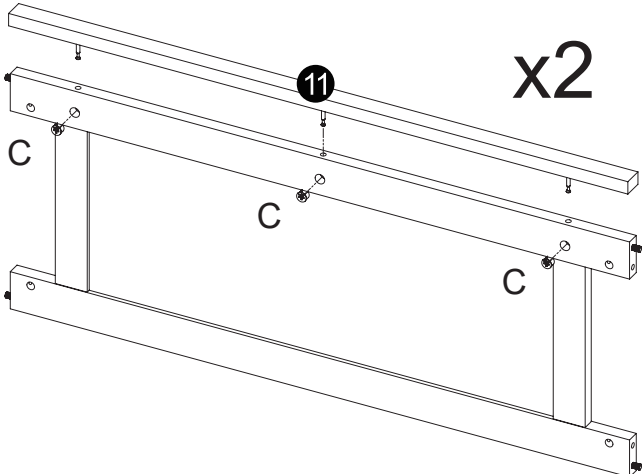
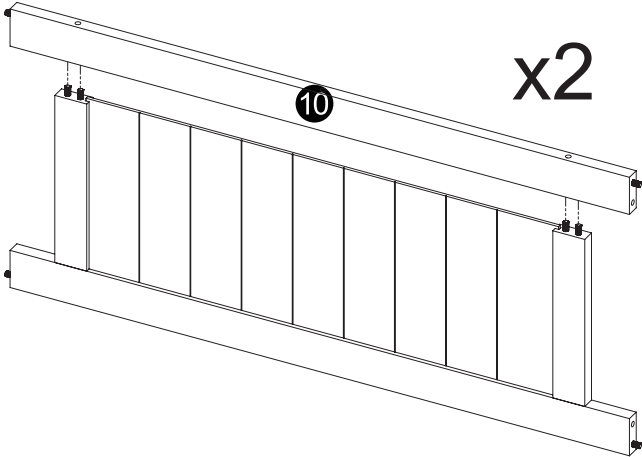
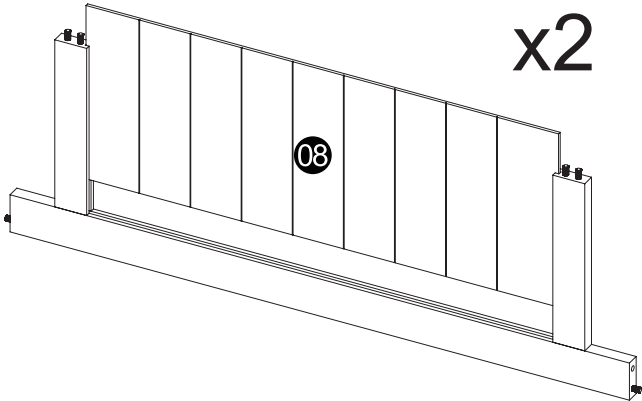
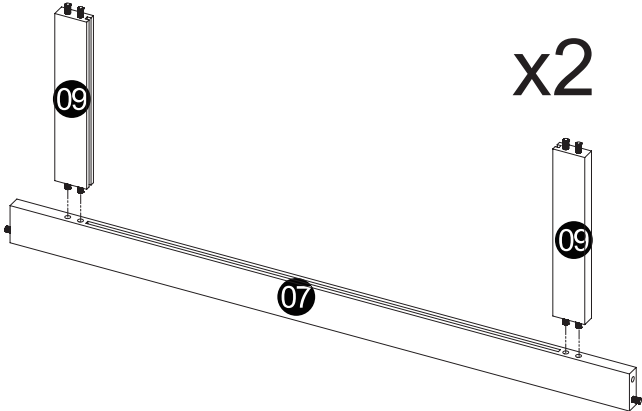

Step 3

D x16

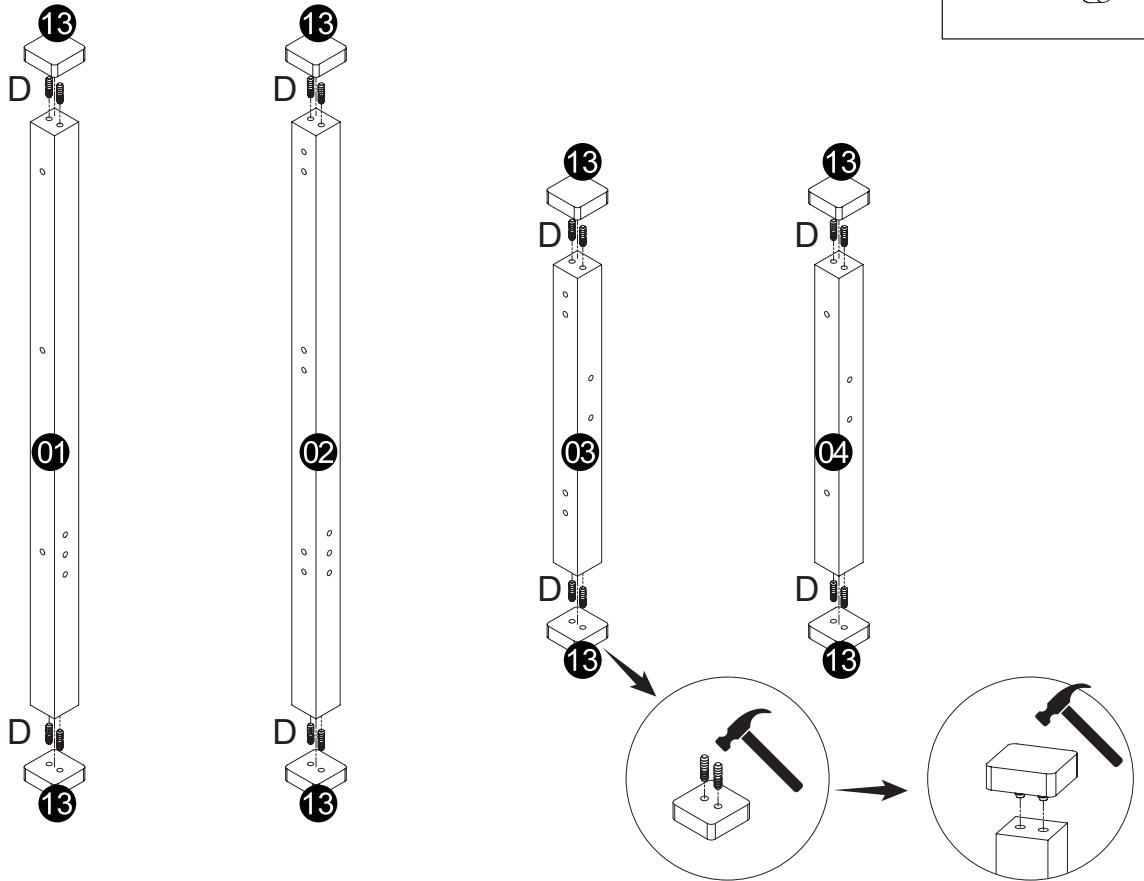
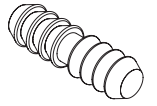

Step 4

E x10



M6x85

F x10

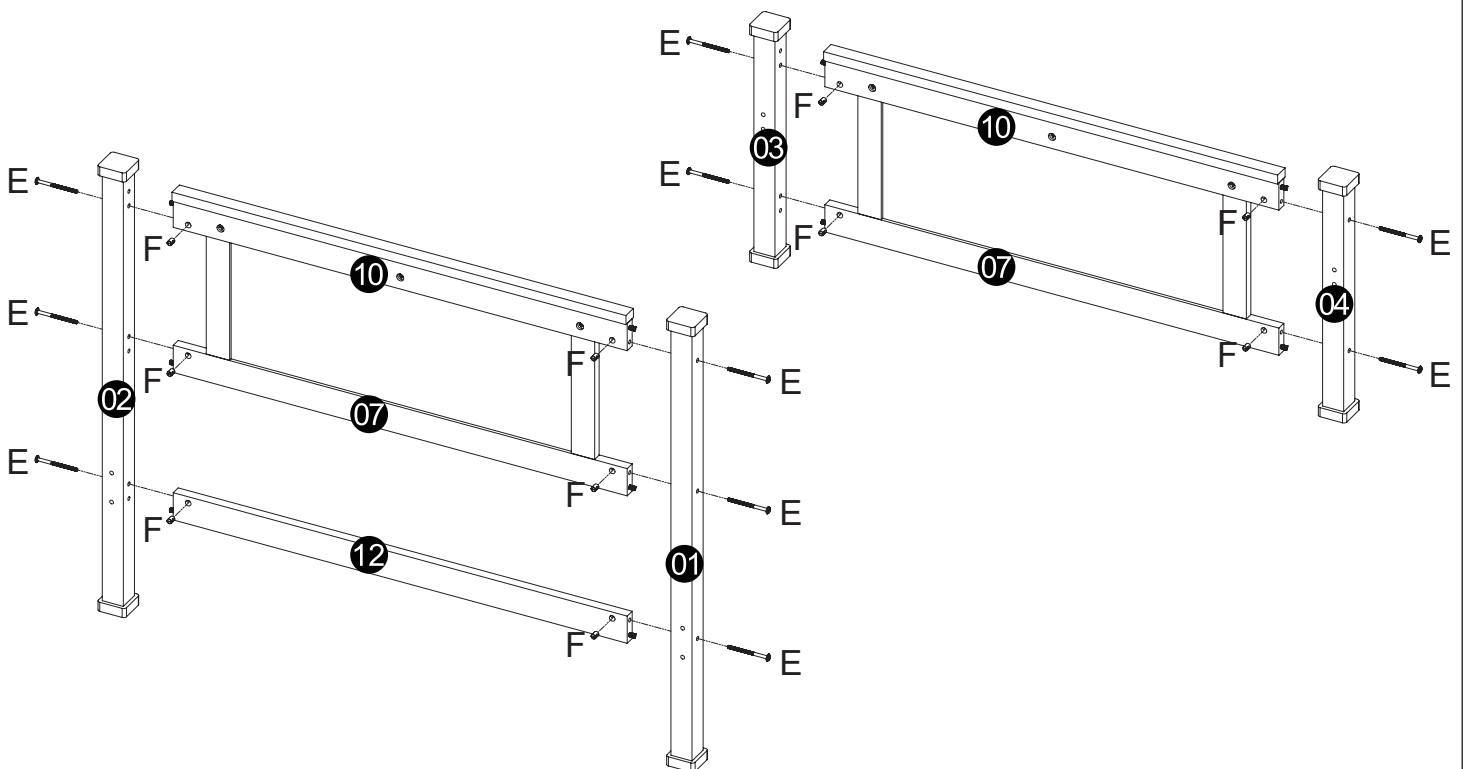

Step 5

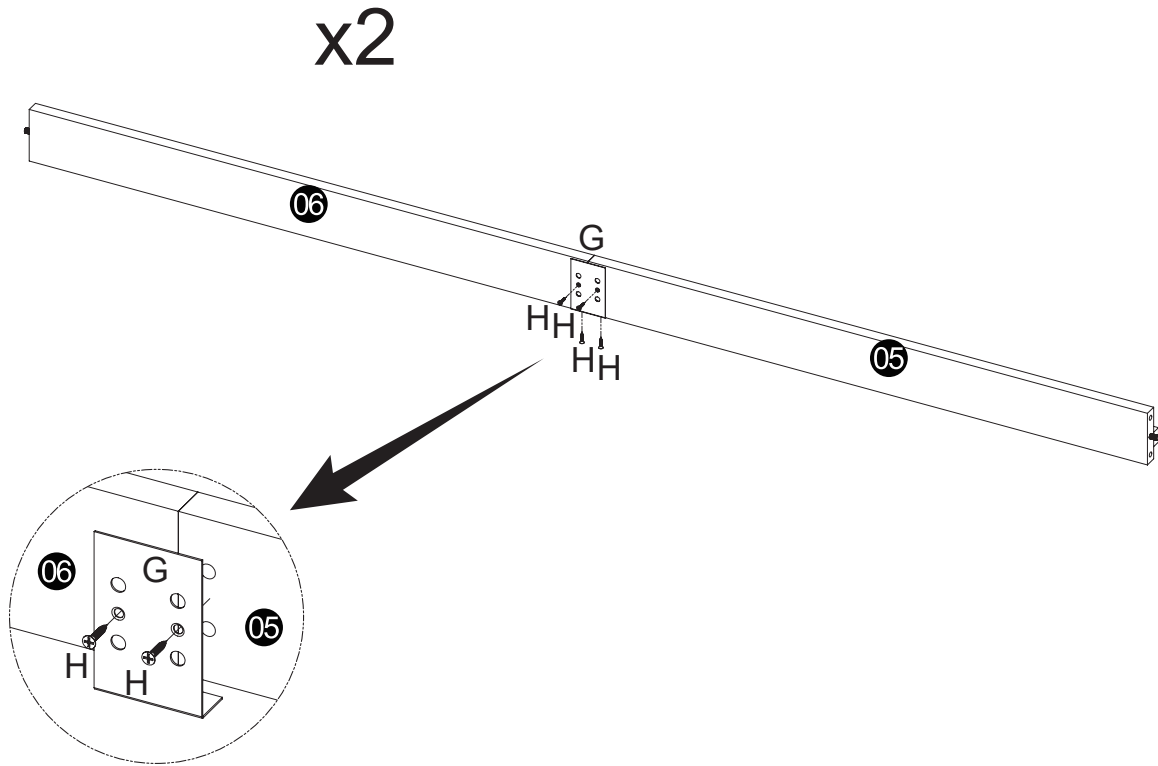
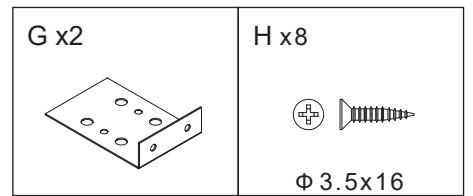

Step 6

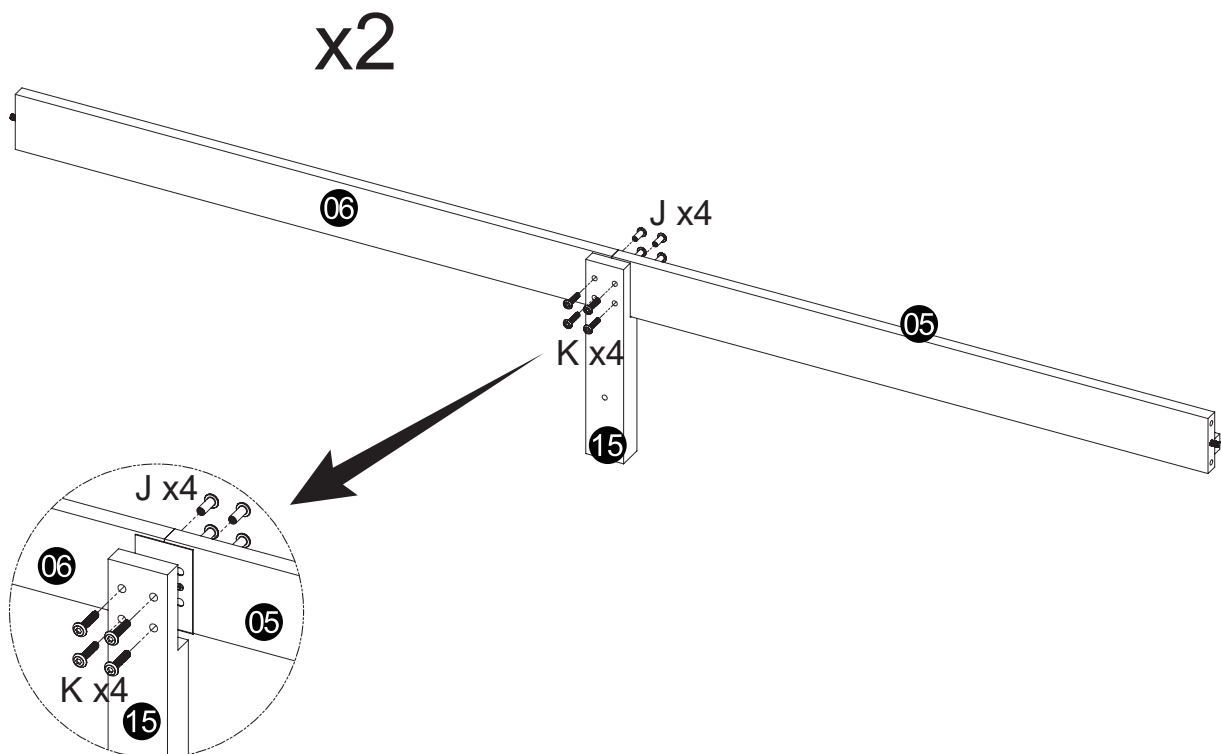
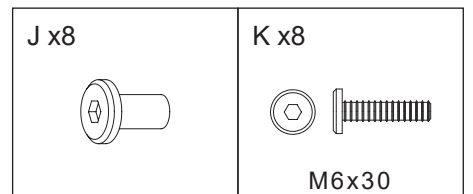

Step 7

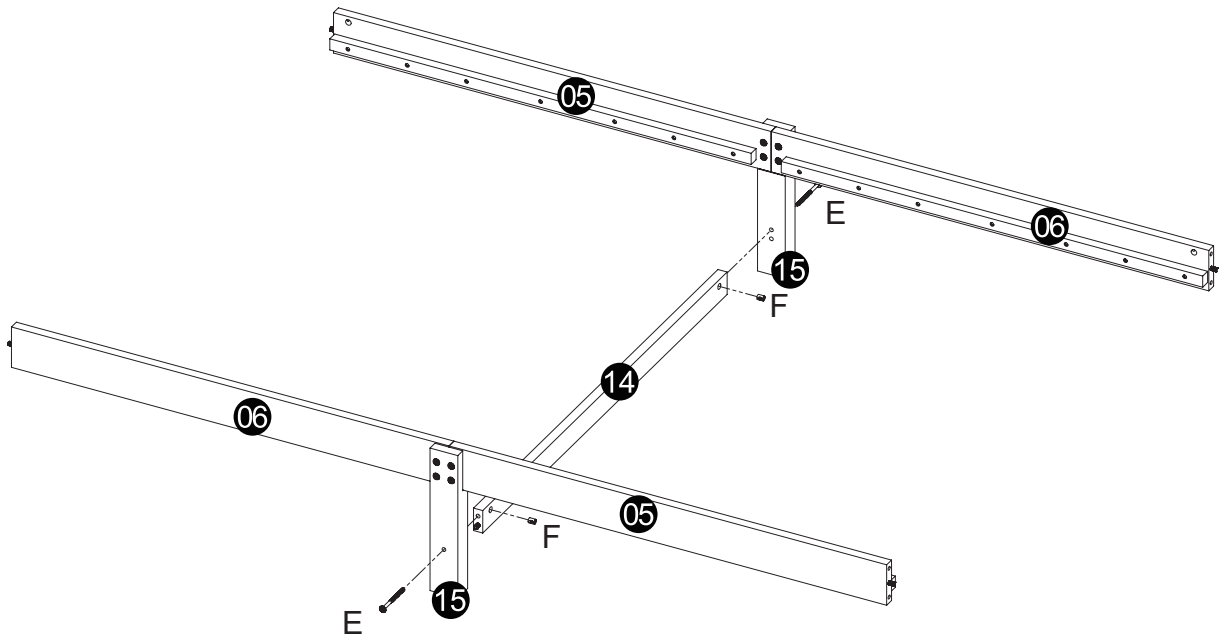
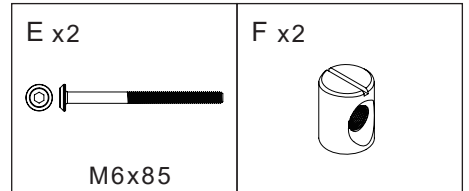

Step 8

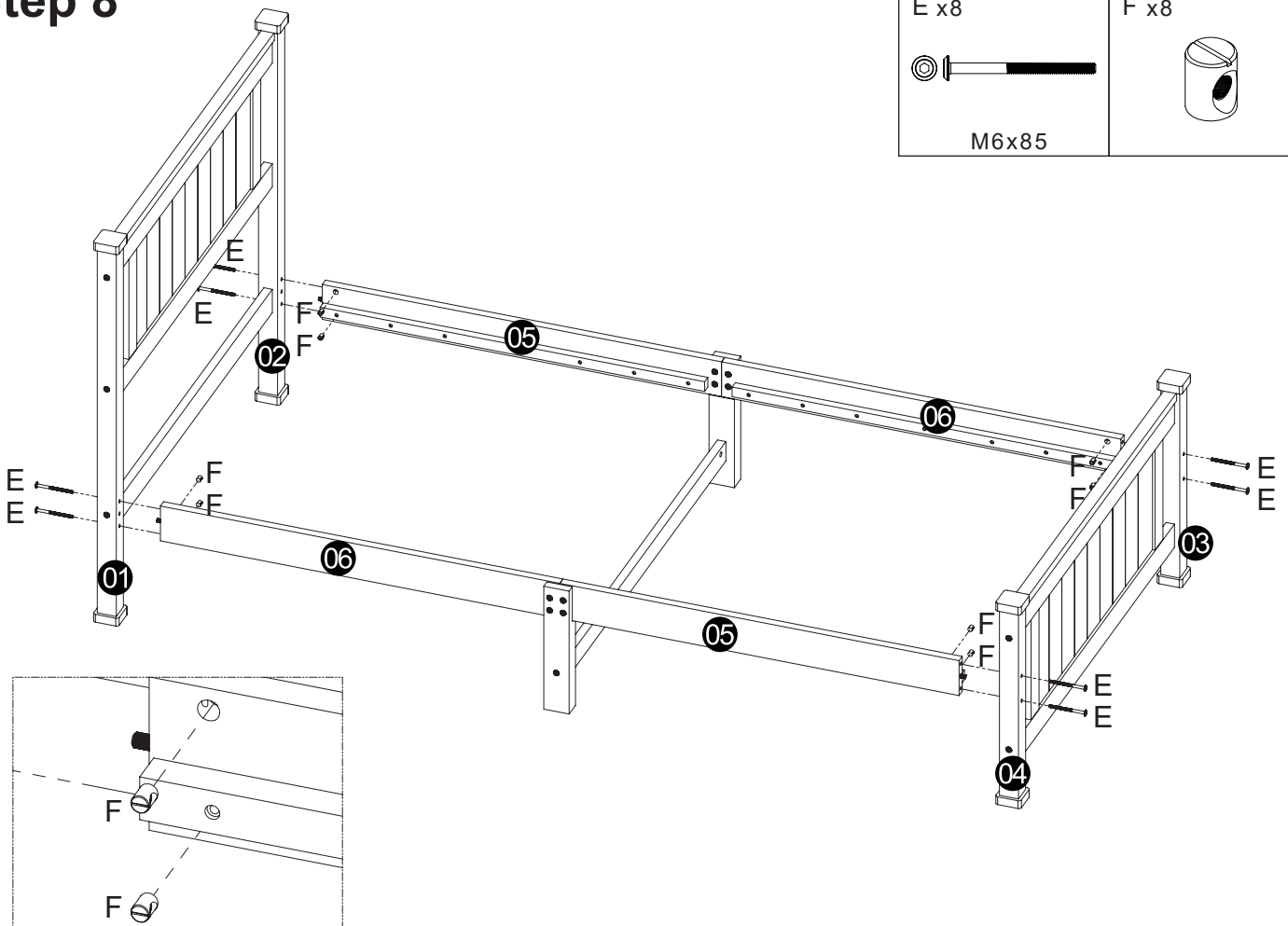
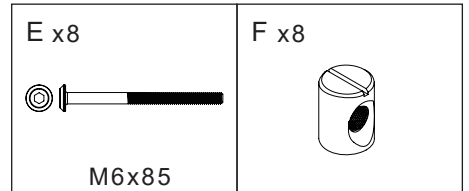

Step 9

L x24



Φ4x30

