

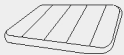













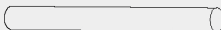

USER'S MANUAL

Dinning Table and Chair Set

THIS INSTRUCTION BOOKLET CONTAINS **IMPORTANT** SAFETY INFORMATION. PLEASE READ AND KEEP FOR FUTURE REFERENCE.

No	PARTS LIST	QTY(PCS)
A		1
B		1
C-L	 (left)	1
C-R	 (right)	1
D		1
E	 M6*45	2
F	 M6*16	4
G	 M4*45	4
H	 4#	1
I		1
J		4
K		4
L		4
M		4
N		4
O		4
P		1

STEP 1

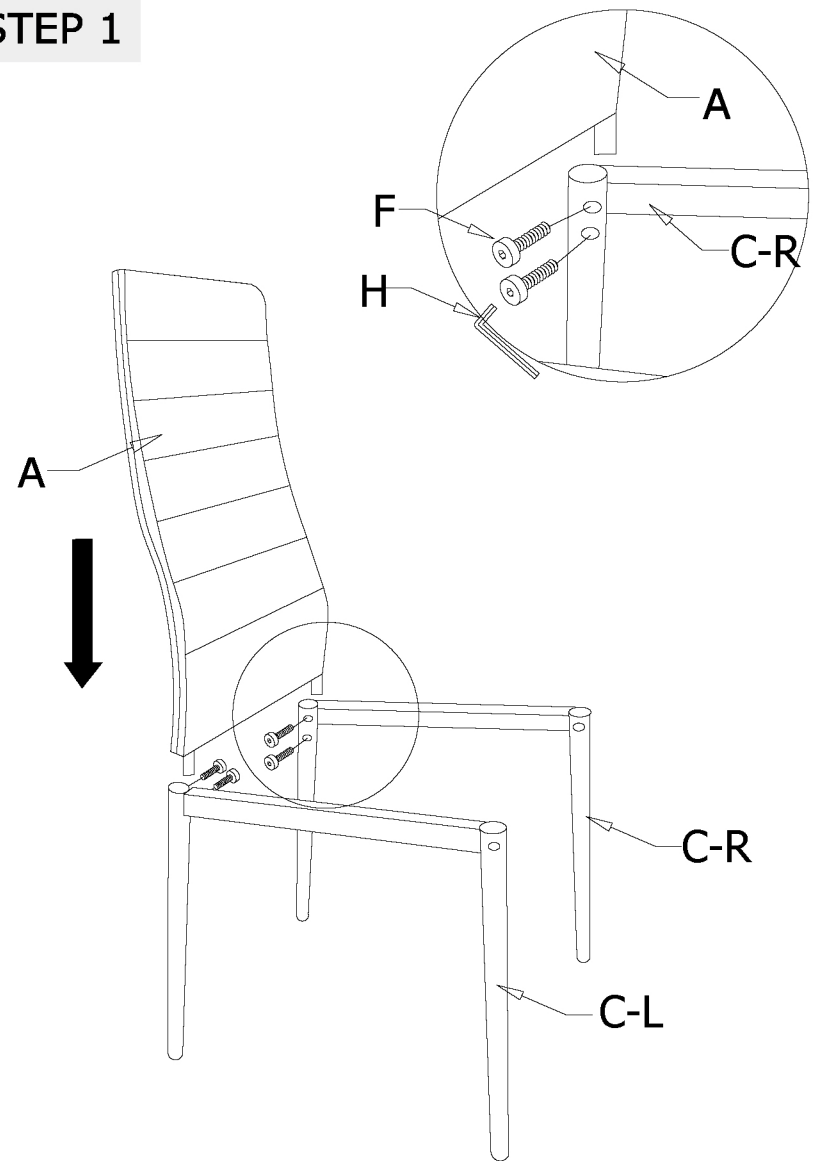

Please do not tighten the bolts(F)until step 3.

STEP 2

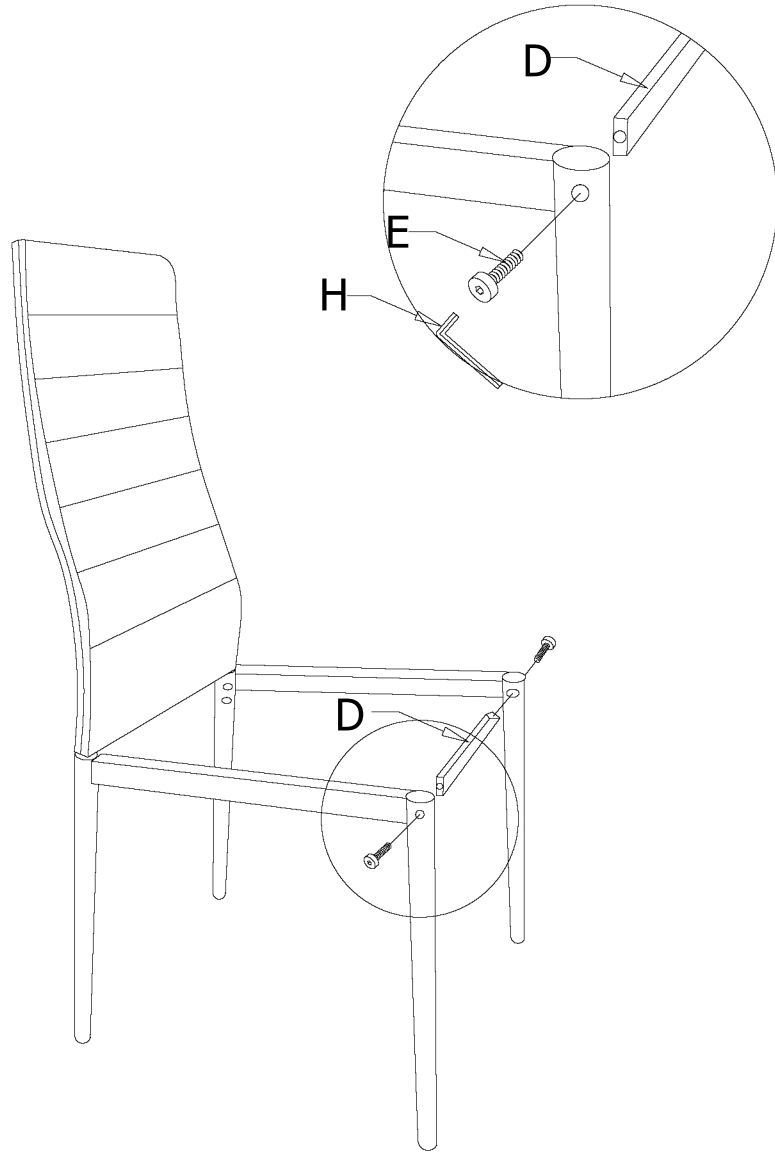

STEP 3

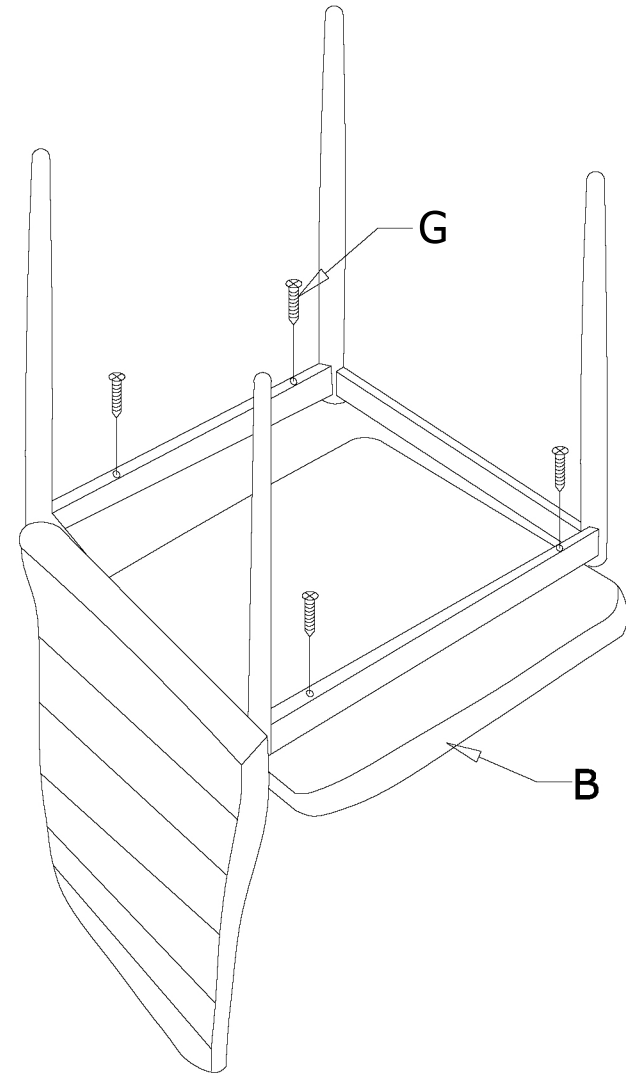

STEP 4

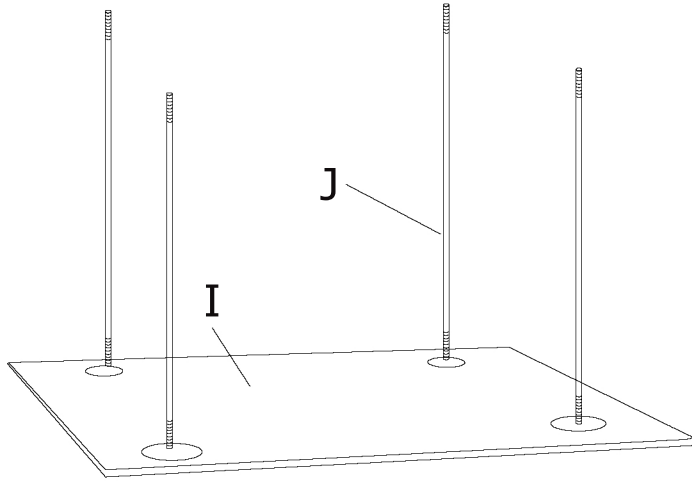

STEP 6

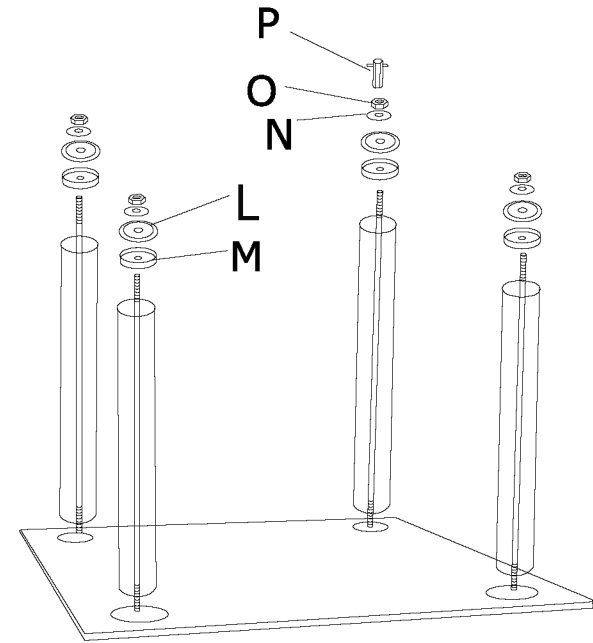

STEP 5

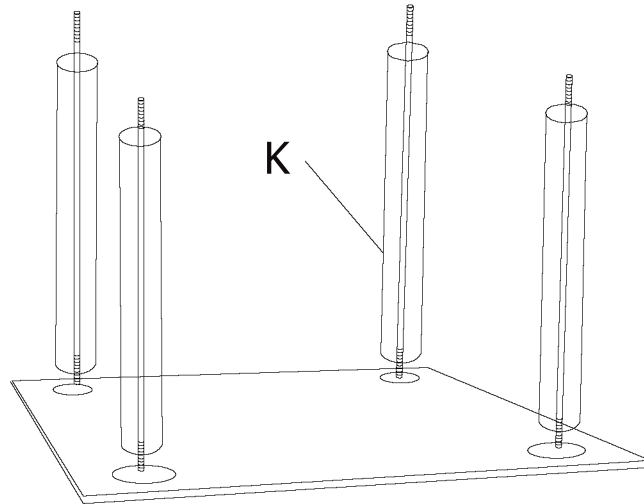

STEP 7

