

ASSEMBLY INSTRUCTIONS

TEAKWOOD LARGE CUSHION BOX WITH COVER BASE (ATF85)

PARTS

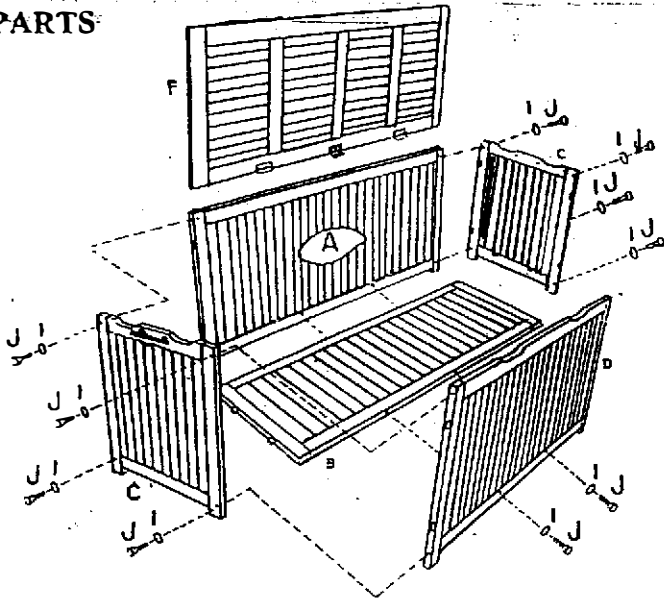

STEP 1

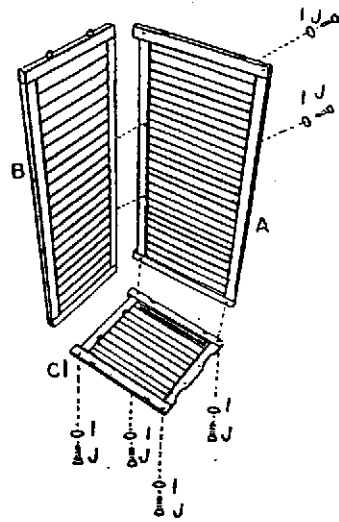

STEP 2

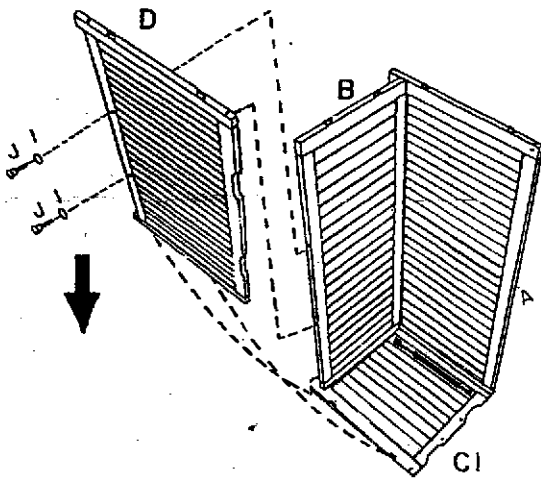

STEP 3

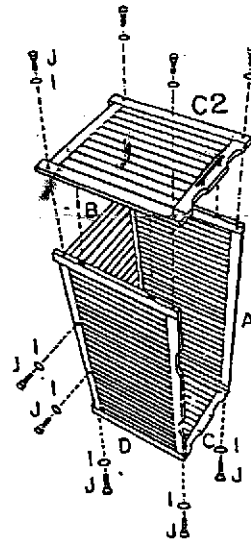



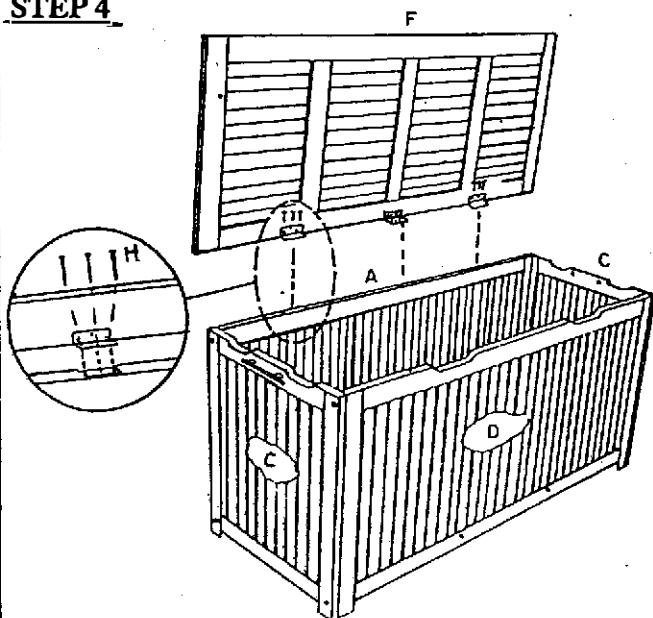

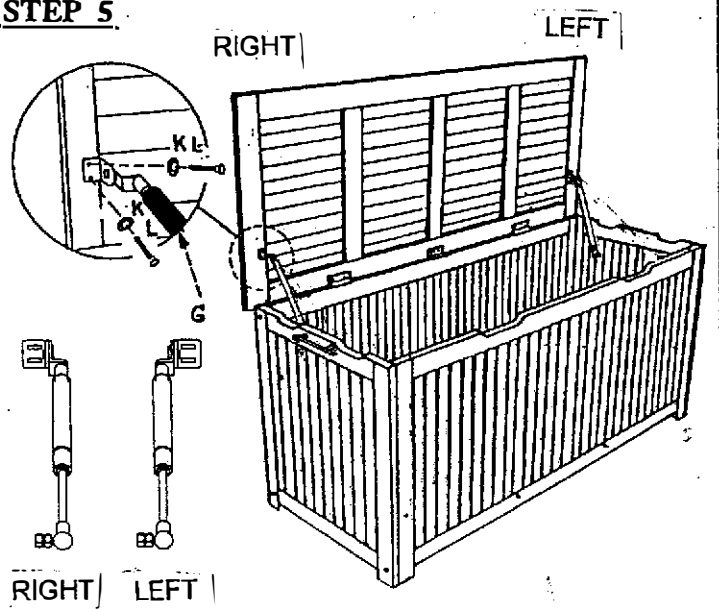

STEP 4

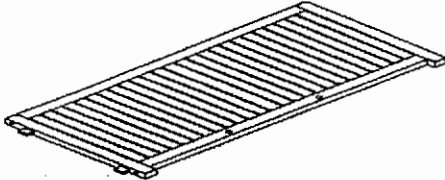
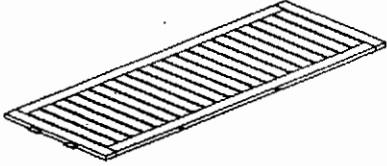
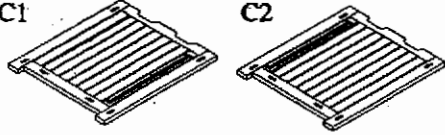
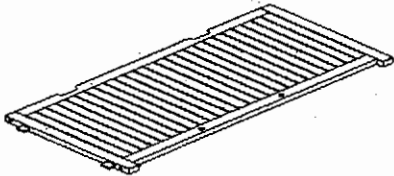
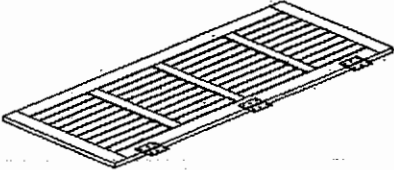
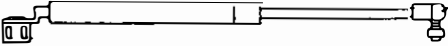
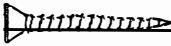

STEP 5



ASSEMBLY INSTRUCTIONS
TEAKWOOD LARGE CUSHION BOX WITH COVER BASE (ATF85)

NO	PARTS	QTY
A	BACK PANEL 	1
B	BASE 	1
C1 C2	LEFT PANEL RIGHT PANEL 	2
D	FRONT PANEL 	1
F	TOP PANEL 	1
G	PISTON 	2
H	BRASS SCREW 	9
I	FIBRE WASHER 	12
J	STUD 	12
K	WASHER 	4
L	STAINLESS STEEL SCREW 	4
M	HEXAGONAL WRENCH 	1