

USE AND CARE GUIDE

52-INCH CEILING FAN

SIZE:φ57"X H11"-16"-21"

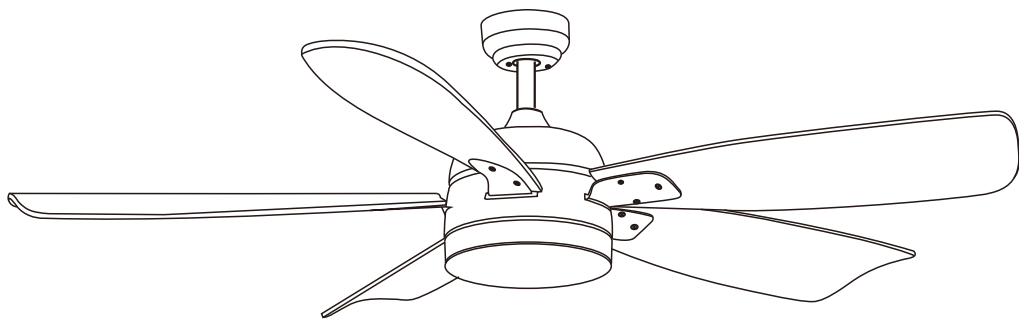

Table of Contents

Safety Information	-----	2	Attaching the Fan Blades	-----	6
Pre-Installation	-----	3	Attaching the Lights	-----	7
Hardware included	-----	4	Use of remote control	-----	8
Ceiling	-----	5	Care and cleaning	-----	9
Hanging the Fan	-----	6			

Safety Information

1. To reduce the risk of electrical shock the electricity has been turned off at the circuit breaker or fuse box before begin.
2. All wiring must be in accordance with the National Electrical Code NASI/NFPA 70 -1999 and local electrical codes. Electrical installation should be performed by a qualified licensed electrician .
3. The outlet box and support structure must be securely mounted and capable of reliably supporting 35lb. (15.9kg). Use only UL listed outlet boxes marked "Acceptable for Fan Support of 35lbs(15.9kg)or less."
4. The fan must be mounted with a minimum of 7 ft. (2m) clearance from the trailing edge of the blades to the floor.
5. Do not operate the reversing switch while the fan blades are in motion. You must turn the fan off and stop the blades before you reverse the blade direction.
6. Do not place objects in the path of the blades.
7. To avoid personal injury or damage to the fan and other items use caution when working around or cleaning the fan.
8. Electrical diagrams are for reference only. Light kits that are not packed with the fan must be UL-listed and marked suitable for use with the model fan you are installing. Switches must be UL General Use Switches. Refer to the instructions packaged with the light kits and switches for proper assembly.
9. After making electrical connections ,spliced conductors should be turned upward and pushed carefully up into the outlet box.The wires should be spread apart with the grounded conductor and the equipment-grounding conductor on one side of the outlet box.
10. All setscrews must be checked and retightened where necessary before installation.



WARNING:TO reduce the risk of personal injury, do not bend the blade brackets (also referred to as flanges) during assembly or after installation.Do not insert objects in the path of the blades .



WARNING: Remove the rubber motor stops on the bottom of the fan before installing the blades or testing the motor.



WARNING: To reduce the risk of fire or electric shock, do not use this fan with any solid-state speed control device.



WARNING:To avoid possible electrical shock, turn the electricity off at the main fuse box before wiring.If you feel you do not have enough electrical wiring knowledge or experience, contact a licensed electrician.



WARNING: Electrical diagrams are for reference only. Optional use of any light kit shall be UL-listed and marked suitable for use with this fan.



WARNING: To reduce the risk of fire, electric shock, or personal injury, mount to outlet box marked "Acceptable for fan support of 35 lbs.(15.9 kg) or less." and use the screws provided with the outlet box.

Warranty

The supplier warrants the fan motor to be free from defects in workmanship and material present at time of shipment from the factory for a lifetime after the date of purchase by the original purchaser. The supplier also warrants that all other fan parts, excluding any glass or acrylic blades, to be free from defects in workmanship and material at the time of shipment from the factory for a period of one year after the date of purchase by the original purchaser. We agree to correct such defects without charge or at our option replace with a comparable or superior model if the product is returned. To obtain warranty service, you must present a copy of the receipt's proof of purchase. All costs of removing and reinstalling the product are your responsibility. Damage to any part, such as by accident, misuse, improper installation or by affixing any accessories, is not covered by this warranty. Because of varying climatic conditions this warranty does not cover any changes in brass finish, including rusting, pitting, corroding, tarnishing, or peeling. Brass finish of this type give their longest useful life when protected from varying weather conditions. A certain amount of "wobble" is normal and should not be considered a defect. Servicing performed by unauthorized persons shall render the warranty invalid. There is no other express warranty, hereby disclaims any and all warranties, including but not limited to those of merchantability and fitness for a particular purpose to the extent permitted by law. The duration of any implied warranty which cannot be disclaimed is limited to the time period as specified in the express warranty. Some states do not allow a limitation on how long an implied warranty lasts, so the above limitation may not apply to you. The retailer shall not be liable for incidental, consequential, or special damages arising out of or in connection with product use or performance except as may otherwise be accorded by law. Some states do not allow the exclusion of incidental or consequential damages, so the above exclusion or limitation may not apply to you. This warranty gives specific legal rights, and you may also have other rights which vary from state to state. This warranty supersedes all prior warranties. Shipping costs for any return of products as part of a claim on the warranty must be paid by the customer.

Pre-Installation

TOOLS REQUIRED



Phillips
screwdriver



Flat blade
screwdriver



Step
ladder



Wire
stripper





Electrical
tape

Pre-Installation(continued)

HARDWARE INCLUDED

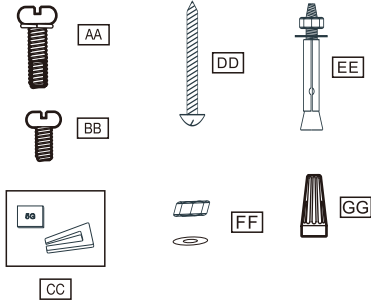
components table







 NOTE: Hardware not shown to actual size.

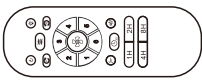
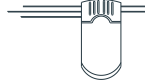

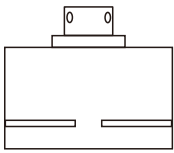
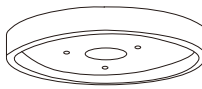
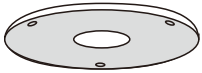

AA	Blade attachment screw and fiber washer (preassembled)	6
BB	Light kit mounting screw (preassembled)	3
CC	Balanced parts package	1
DD	Mounting screws	4
EE	Expansion Bolts	2
FF	Lock washer (preassembled)	5
GG	Plastic wire nut (not to scale)	5

PACKAGE CONTENTS

	
K Remote control (Transmitter)	L Remote control (Receiver)
1	1

		
A Fan-motor assembly	B Lamp pan	C LED light kit
1	1	1

		
D Glass Lampshade	E AM (with pre-installed screws)	F Blade
1	5	5

		
F Slide-on mounting bracket (inside canopy)	H 12.5CM Ball/downrod assembly	J Coupling cover
1	1	1
		
G Canopy	I 25CM Ball/downrod assembly	J Coupling cover
1	1	1

Installation of the hanging bracket (suspension part)

Wooden ceiling

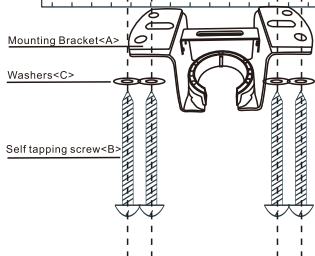

For wooden ceiling, use wood screw to drill on the wooden beam or the "junction box" to fix the hanging bracket (selection is made according to actual requirements of the customers).

STEP 1A-WOODEN CEILING

SWITCH OFF THE ELECTRICAL MAINS AT THE CIRCUIT BREAKER FUSE BOX.

- 1) Use the Mounting Bracket (A) as a guide, mark the spots where the 4 Self Tapping Screws (B) will be drilled.
- 2) Remove the Mounting Bracket (A), drill 4 holes for 3MM diameter, install the mounting bracket onto wooden ceiling with the 4 Self Tapping Screws (B) & Washers (C).

⚠ IMPORTANT : SCREWS MUST BE TIGHTENED TILL SNUG

CONCRETE CEILING

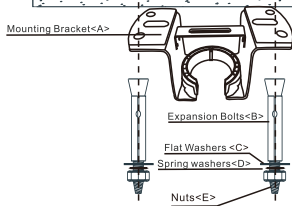

⚠ Note: According to the ceiling of different materials, use different screws to fix the hanging bracket. Don't fix the hanging bracket on the wood ceiling less than 12MM to prevent danger caused by loosening of screws. After the hanging bracket is completed, ensure that it can withstand the tension test of more than 68KG for safety.

For concrete ceiling, use the percussion bit with diameter 8mm to drill holes according to the length of expansion screws. Then use the attached expansion screws to fix the hanging bracket onto the ceiling (selection is made according to actual requirements of the customers).

STEP 2A - CONCRETE CEILING

SWITCH OFF THE ELECTRICAL MAINS AT THE CIRCUIT BREAKER FUSE BOX.

- 1) Use the Mounting Bracket (A) as a guide, mark the spots where the 4 Expansion Bolts (B) will be drilled.
- 2) Remove the Mounting Bracket (A), drill 4 holes and insert 4 Expansion Bolts (2) into the concrete ceiling, install the mounting bracket and secure with Flat Washers (C), Spring Washers (D) and Nuts (E).

IMPORTANT : SCREWS & NUTS MUST BE

⚠ TIGHTENED TILL SNUG

Install the hanging part of the ceiling fan.

1. install downrod assembly

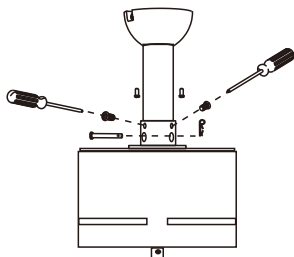

1. Thread the suspender through the suspended clock and coupling cover .
2. Then insert the tail of the suspender from the lifting head of the motor.
3. After the lateral pin is threaded out from the suspended head position, insert R type pin.
4. Tighten the lifting head screws.
5. Hang the fan of the hanging pipe into the hanger.



⊕ Phillips screwdriver

Assembly – Hanging the Fan(continued)

Preparing for mounting

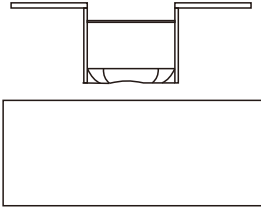

- 1: Remove the mounting bracket from the canopy by loosening the two canopy screws located in the L shaped slots.
- 2: Remove and save the two canopy screws in the round holes. This will enable you to remove the mounting bracket



Install remote control

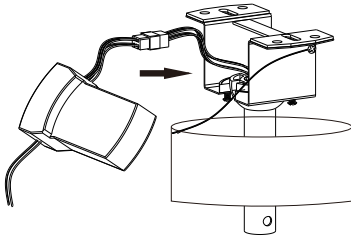

1. Carefully push the canopy to the bottom of the mounting bracket, make two sliding holes aligned to the two prominent screws on the mounting bracket, and then turn clockwise until tight.

2. Push the canopy ring to the bottom of the canopy, slide the inner holes aligned to the two prominent screws on the mounting bracket again, and turn the canopy ring clockwise until tight.

remote control <ONLY>

Preparing for mounting

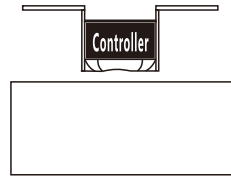

- 1: Remove the mounting bracket from the canopy by loosening the two canopy screws located in the L shaped slots.
- 2: Remove and save the two canopy screws in the round holes. This will enable you to remove the mounting bracket

Install the hanging part of the ceiling fan.

1. install downrod assembly

Suspended Installation Only

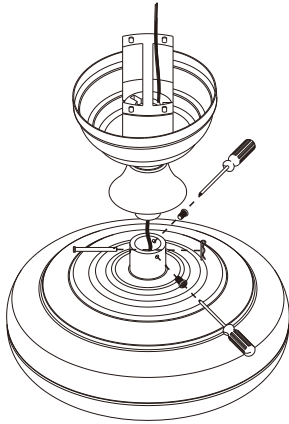

1. Thread the suspender through the suspended clock and coupling cover.
2. Then insert the tail of the suspender from the lifting head of the motor.
3. After the lateral pin is threaded out from the suspended head position, insert R type pin.
4. Tighten the lifting head screws.
5. Hang the fan of the hanging pipe into the hanger.



⊕ Phillips
screwdriver

⚠ WARNING

WARNING: Failure to properly install the locking pin could result in the fan becoming loose and possibly falling.

Assembly – Hanging the Fan(continued)

2. Suspended Installation

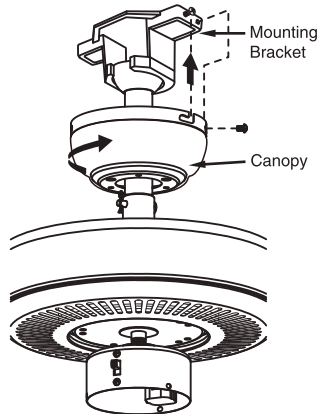
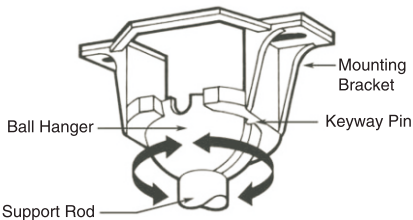

1. Notice the half ball on the end of the support rod is grooved down one side. This key way fits over the small keyway pin on the inside of the mounting bracket and keeps the ceiling fan from spinning on the mounting bracket.

2. Using your step ladder, lift the fan and place the half ball in the center of the mounting bracket with the keyway pin inserted into the keyway on the ball. Turn the fan left and right slightly to make sure it is seated on the bracket with the key way pin in the keyway.

3. Slide the canopy up into place over the ceiling mounting bracket. Loosen up the canopy screws on the side of the canopy screws. Press the canopy against the mounting bracket and turn it clockwise. Tighten screws on the J Slots and install the two screws in the remaining holes.

Install the hanging part of the ceiling fan.

1. Install flushmount assembly

Flushmount Installation Only

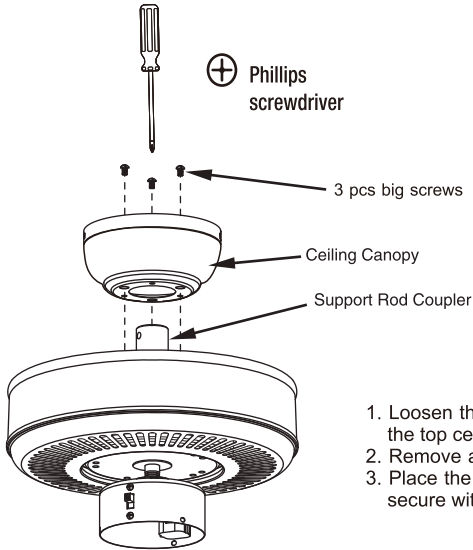

1. Loosen the set screws in the support rod coupler located on the top center of the motor housing until the inside channel is clear.
2. Remove and save the safety screw from the coupler.
3. Place the ceiling canopy on the top of the motor housing and secure with the three mounting screws.

Assembly – Hanging the Fan(continued)

2. Flushmount Installation

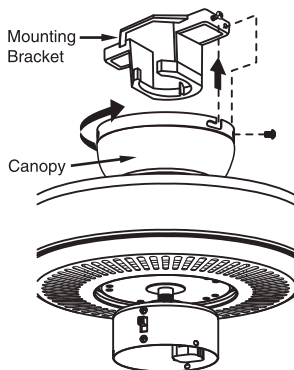

- Slide the canopy up into place over the ceiling mounting bracket. Loosen up the canopy screws on the side of the canopy screws. Press the canopy against the mounting bracket and turn it clockwise. Tighten screws on the J Slots and install the two screws in the remaining holes.

Assembly – Attaching the Fan Blades

1. Attaching the blades to the arms

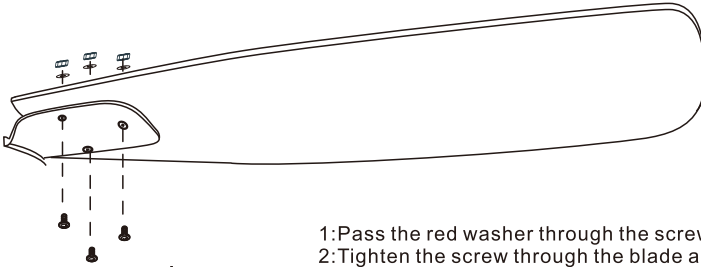

- 1: Pass the red washer through the screw.
- 2: Tighten the screw through the blade and tighten it on the arms.
- 3: Repeat the above steps to tighten the four sets of blades.

 Phillips
screwdriver

2. Fastening the blade to the motor

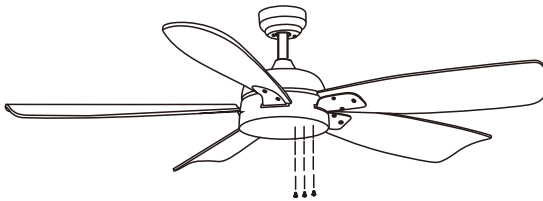

NOTE: Your fan blades are reversible. Select the blade side finish which best accentuates your decor.



NOTE: Your fan features revolutionary advancements for quick and easy blade installation. Including an alignment post and captive blade arm screws.



WARNING: Remove the rubber motor stops on the bottom of the fan before installing the blades or testing the motor.



 Phillips
screwdriver

1. Fasten the Blade to the fan-motor assembly by inserting the alignment post into the slot on the bottom of the motor and tightening the pre-installed Blade screws.

2. Repeat this step for the remaining blade assemblies.

Assembly – Attaching the Lights

1. Install the lamp fitter



CAUTION: To reduce the risk of electric shock, disconnect the electrical circuit to the fan before installing the light fixture.

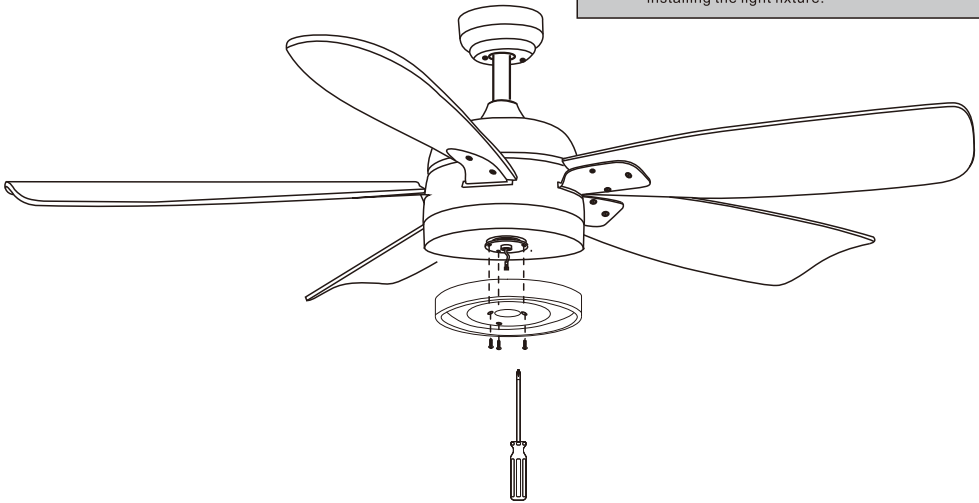

Assembly – Attaching the Lights

2. Connecting lamp wire



CAUTION: To reduce the risk of electric shock, disconnect the electrical circuit to the fan before installing the light fixture.

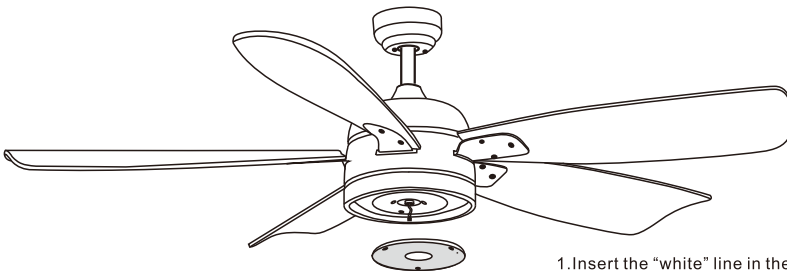

1. Insert the "white" line in the switching box of the motor into the "white" line of the light and tie insulated rubber tape.
2. Insert the "blue" line in the switching box of the motor into the "blue" line of the light and tie insulated rubber tape.

Assembly – Attaching the Lights

3. Install the lamp cover



WARNING: Allow the shatter resistant bowl to cool completely before removing.



CAUTION: Make sure the power is off before attaching or removing the shatter resistant bowl.



CAUTION: Do not over tighten the hex nut, overtightening the hex nut may cause the shatter resistant bowl to break.

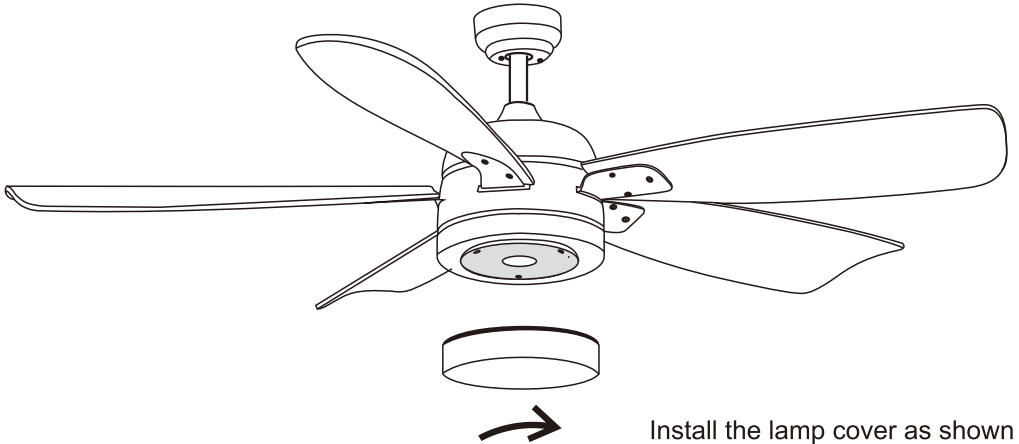

Operation

OPERATING YOUR FAN

Turn on the power and check the operation of the fan. The remote controls the fan speed and light.

The appropriate speed settings for warm or cool weather depends on factors such as the room size, ceiling height, and number of fans.

The slide switch (XX) controls the direction of the blades: forward (switch down) or reverse (switch up).



NOTE: Wait for the fan to stop before reversing the direction of the blade rotation

A. Warm weather-(Forward) A downward airflow creates a cooling effect. This allows you to set your air conditioner on a higher setting without affecting your comfort.

B. Cool weather-(Reverse) An upward airflow moves warm air off of the ceiling. This allows you to set your heating unit on a lower setting without affecting your comfort.

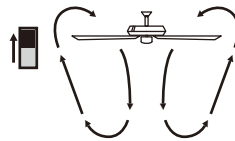

A. Warm Weather
(summertime)

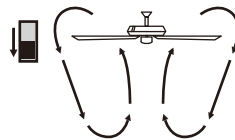

B. Cool Weather
(wintertime)

Use of remote control

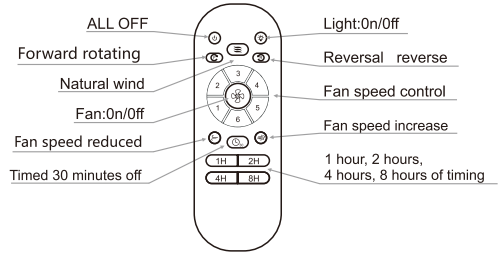
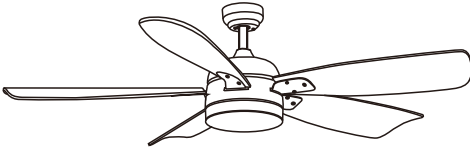

Batteries not included

Please use 2PCS 1.5V AAA battery for remote

Remote control wiring diagram

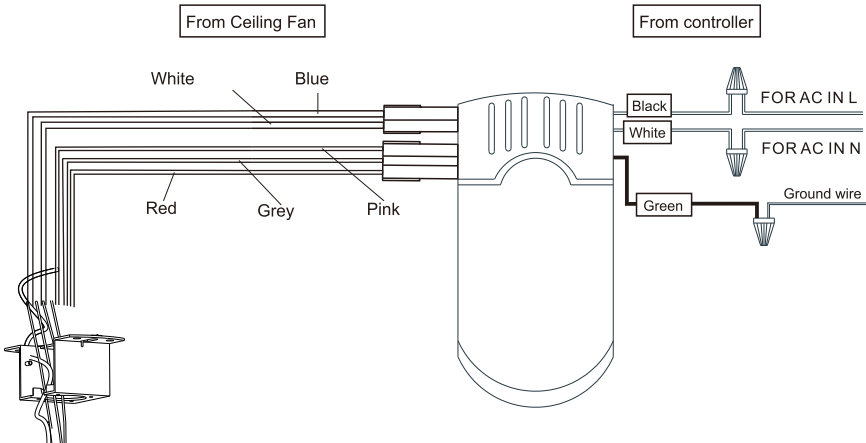

Assembly – Hanging the Fan(continued)

Ceiling fans can be installed according to the user's location can be installed in the standard ball, slope ball installation and ceiling installation

Height for Ceiling Mounted: **11"**

Height with 5" rod: **16"**

Height with 10" rod: **21"**

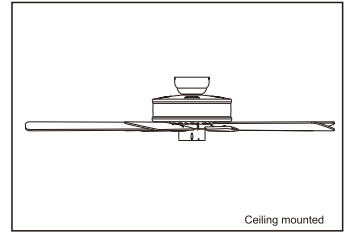
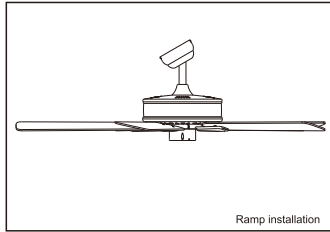
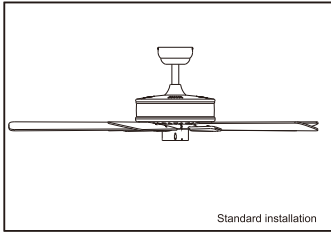

Standard drop ball installation is suitable for general building installation, ramp drop ball installation is suitable for installation on the inclined plane (inverted as inclined roof). The ceiling type installation is suitable for the lower floor space.

The slope drop ball type installation method is basically the same as the standard drop ball type installation method, except that the location of the hanger installation varies.

Care and Cleaning



WARNING: Make sure the power is off before cleaning your fan.

- Because of the fan's natural movement, some connections may become loose. Check the support connections, brackets, and blade attachments twice a year. Make sure they are secure. It is not necessary to remove the fan from the ceiling.
- Clean your fan periodically to help maintain its new appearance over the years. Do not use water when cleaning, as this could damage the motor or the wood, or possibly cause an electrical shock. Use only a soft brush or lint-free cloth to avoid scratching the finish. The plating is sealed with a lacquer to minimize discoloration or tarnishing.
- You can apply a light coat of furniture polish to the wood for additional protection and enhanced beauty. Cover small scratches with a light application of shoe polish.
- You do not need to oil your fan. The motor has permanently-lubricated sealed ball bearings.

Troubleshooting

Problem	Solution
The fan will not start.	<ul style="list-style-type: none"> <input type="checkbox"/> Check the main and branch circuit fuses or breakers. <input type="checkbox"/> Check the line wire connections to the fan and switch wire connections in the switch housing.
The fan will not start.	<ul style="list-style-type: none"> <input type="checkbox"/> Ensure all motor housing screws are snug. <input type="checkbox"/> Ensure the screws that attach the fan blade bracket to the motor hub are tight. <input type="checkbox"/> Ensure the wire nut connections are not ratting against each other or the interior wall of the switch housing. <input type="checkbox"/> Allow a 24-hour "breaking in" period. Most noises associated with a new fan disappear during this time. <input type="checkbox"/> If you are using the Ceiling Fan light kit, ensure the screws securing the glassware are tight. Check that the light bulbs are also secure. <input type="checkbox"/> Ensure the canopy is a short distance from the ceiling. It should not touch the ceiling. <input type="checkbox"/> Ensure your outlet box is secure and rubber isolator pads were used between the mounting plate and outlet box.
The fan wobbles.	<ul style="list-style-type: none"> <input type="checkbox"/> Check that all blade and blade arm screws are secure. <input type="checkbox"/> Most fan wobble problems are caused when blade levels are unequal. Check this level by selecting a point on the ceiling above the tip of one of the blades. Measure from a point on the center of each blade to the point on the ceiling. Measure this distance. Rotate the fan until the next blade is positioned for measurement. Repeat for each blade. Any measurement deviation should be within 1/8 in. Run the fan for ten minutes. If the fan continues to wobble please contact Customer Service and a balancing kit will be sent to you a

Remote control fan

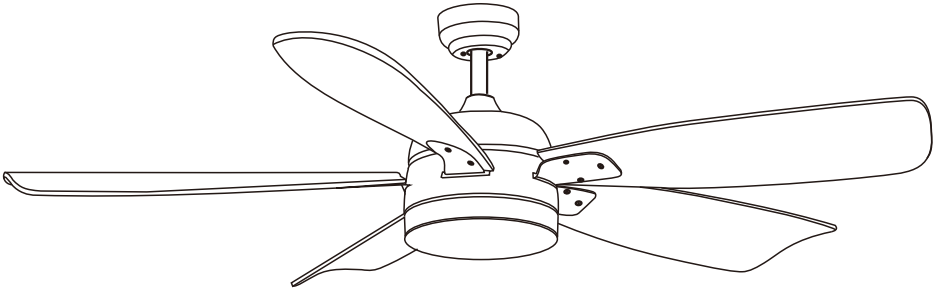

USE AND CARE GUIDE

52-INCH CEILING FAN