

## WARNING

**\*\* WE RECOMMEND INSTALLATION OF THIS LIGHTING FIXTURE BE DONE BY A LICENSED ELECTRICIAN \*\***

- \* Switch off the main electrical supply from the main fuse box / circuit.
- \* Breaker before installation.
- \* Inspect item carefully before attempting to install.
- \* If there is any damages or obvious defects, do not install.
- \* Item may not be returned once it has been installed.









## CARE AND MAINTENANCE

- \* To clean the outside of the fixture, use a dry or slightly dampened clean cloth (use clean water, never a solvent) to wipe the surface of the fixture.
- \* To clean the inside of the fixture, first disconnect power to the fixture by turning off the circuit breaker or by removing the fuse at the fuse box. Next, use a dry or slightly dampened clean cloth (use clean water, never a solvent) to wipe the interior surface of the fixture.
- \* Do not use any cleaners with chemical, solvents or harsh abrasives. Use only a dry soft cloth to dust or wipe carefully.

## NOTICE& IMPORTANT SAFETY INSTRUCTIONS

- \* Please make sure that you have all parts indicated before you begin assembly of this item
- \* This item should be assembled on a soft surface to prevent scratching the finish during assembly
- \* To reduce the risk of fire, electrical shock or injury to persons or property, please follow the guideline below for safe use and installation
- \*The external flexible cable or cord of this lamp cannot be replaced  
If the cord is damaged, the lamp shall be destroyed

### Part List and Hardware List

PIECE	DESCRIPTION	PICTURE	QUANTITY	PIECE	DESCRIPTION	PICTURE	QUANTITY
A	mounting screw		2X	F	lamp body		1X
B	mounting plate		1X	H	glass shade		3X
C	ground screw		1X	I	socket ring		3X
D	wire connector		3X	J	Bulb		3X
E	Round nut		2X				

**Product Dimensions: 22.5"L X 7.25"D X 9.25"H**

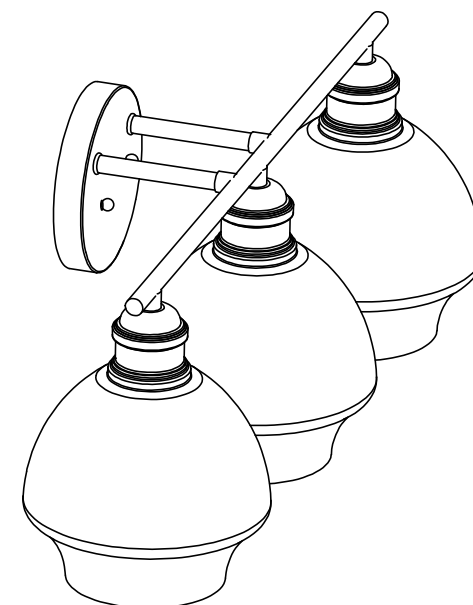

## PREPARATION

- \* Before beginning assembly of product, make sure all parts are present. Compare parts with package contents list and hardware contents list.
- \* If any part is missing or damaged, do not attempt to assemble the product.
- \* Estimated Assembly Time: 20 minutes.
- \* If you are having difficulty, our friendly Customer Care team is always here to help.

**NOTE: PLEASE USE TYPE "A" BULB MAX 40-WATT OR CFL BULB MAX 13-WATT OR LED BULB MAX 9-WATT, THERE IS LED 4-WATT BULB IN THE BOX**

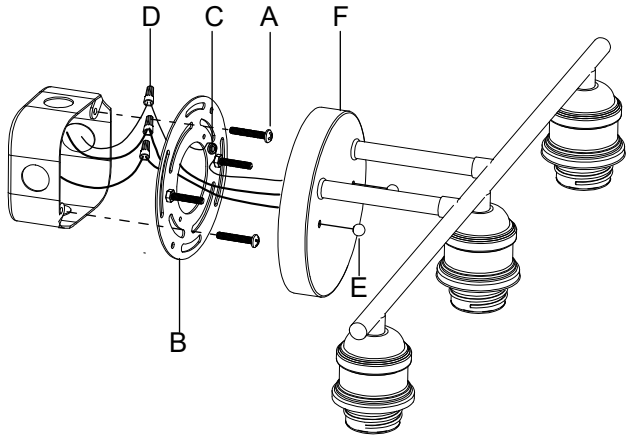

**Step 1:** Secure mounting plate (B) to outlet box with mounting screws (A) .

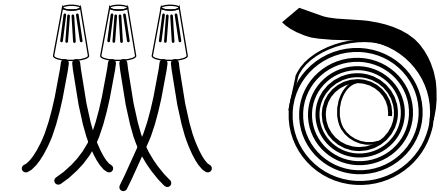
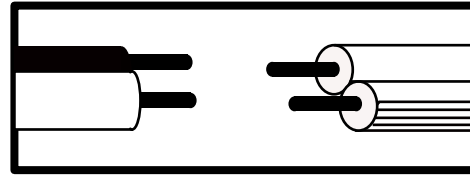

### Step 2: Wire connection

Connect fixture neutral wire (ribbed) to the outlet box neutral wire (usually white) using a wire nut. Connect fixture hot wire (smooth with markings) to the outlet box hot wire (usually black) using a wire nut. CAUTION: Do not reverse the hot and neutral connections

#### Grounding Instructions:

Wrap ground wire from outlet box around green ground screw (C) on mounting bracket, no less than 2" from wire end. Tighten ground screw. If fixture is supplied with a ground wire, connect to outlet ground wire with a wire connector.

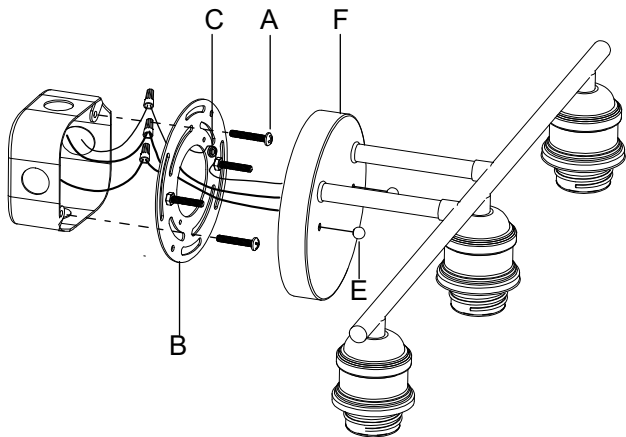

**Step 3:** Attach the lamp body (F) to the Mounting plate (B) and secure with Round nut (E)

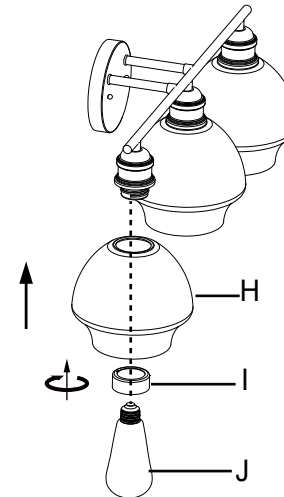

**Step 4:** Place the glass shade (H) on the socket and tighten it clockwise with the socket ring (I) Insert the bulb (J) into the socket