







Twin Size Bunk Bed







## Before You Start

-  Please read all instruction carefully.
-  Retain instructions for future reference.
-  Separate and count all parts and hardware.
-  Read through each step carefully and follow the proper order.
-  We recommend that, where possible, all items are assembled near to the area in which they will be placed in use, to avoid moving the product unnecessarily once assembled.
-  Always place the product on a flat, steady and stable surface.
-  Keep all small parts and packaging materials for this product away from babies and children as they potentially pose a serious choking hazard.



## Return / Damage Claim Instructions

-  **DO NOT** discard the box / original packaging.  
In case a return is required, the item must be returned in original box. Without this your return will not be accepted.
-  Take a photo of the box markings.  
A photo of the markings (text) on the side of the box is required in case a part is needed for replacement. This helps our staff identify your product number to ensure you receive the correct parts.
-  Take a photo of the damaged part (if applicable).  
A photo of the damage is always required to file a claim and get your replacement or refund processed quickly. Please make sure you have the box even if it is damaged.
-  Send us an email with the images requested.  
Email us directly from marketplace where your item was purchased with the attached images and a description of your claim.

FR



## Instructions De Retour / Réclamation De Dommages

**⚠ NE PAS jeter la boîte/l'emballage d'origine.**

Dans le cas où un retour est requis, l'article doit être retourné dans sa boîte d'origine. Sans cela, votre retour ne sera pas accepté.

**⚠ Prenez une photo des marquages de la boîte.**

Une photo des marquages (texte) sur le côté de la boîte est requise au cas où une pièce serait nécessaire pour le remplacement. Cela aide notre personnel à identifier votre numéro de produit pour s'assurer que vous recevez les bonnes pièces.

**⚠ Prenez une photo des dommages (le cas échéant).**

Une photo des dommages est toujours requise pour déposer une réclamation et obtenir rapidement votre remplacement ou votre remboursement. Assurez-vous d'avoir la boîte même si elle est endommagée.

**⚠ Envoyez-nous un e-mail avec les images demandées.**

Envoyez-nous un e-mail directement depuis le marché où votre article a été acheté avec les images ci-jointes et une description de votre réclamation.

D

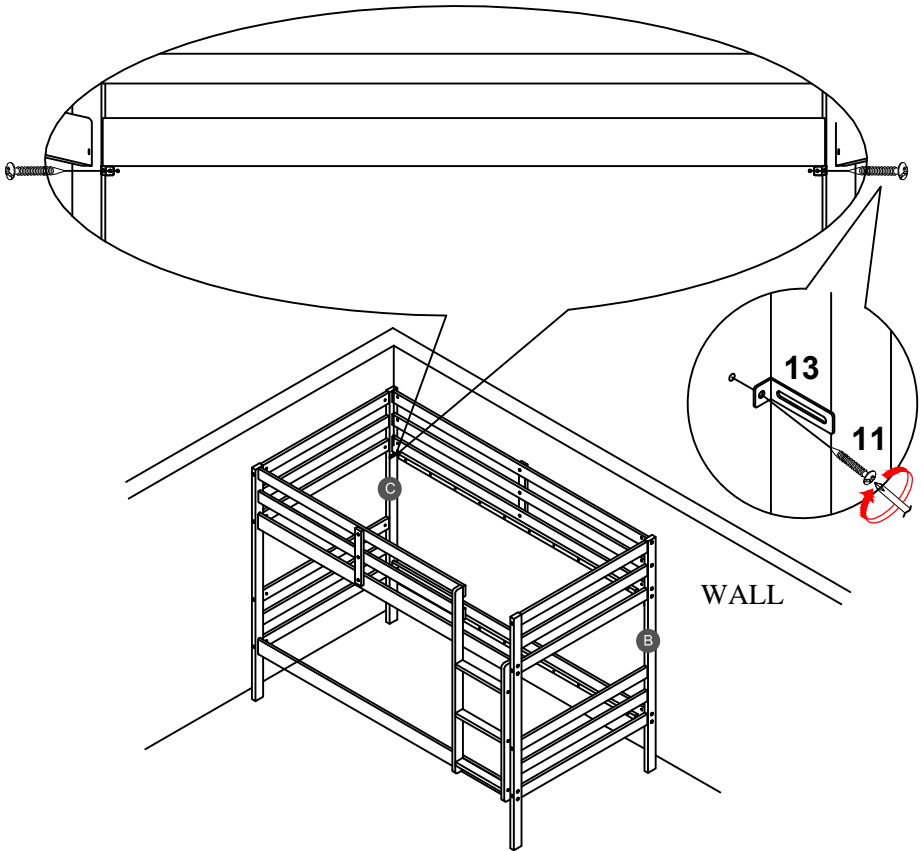
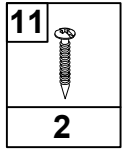

**EN:** Fix the bracket to the wall with screw .

# Detail View

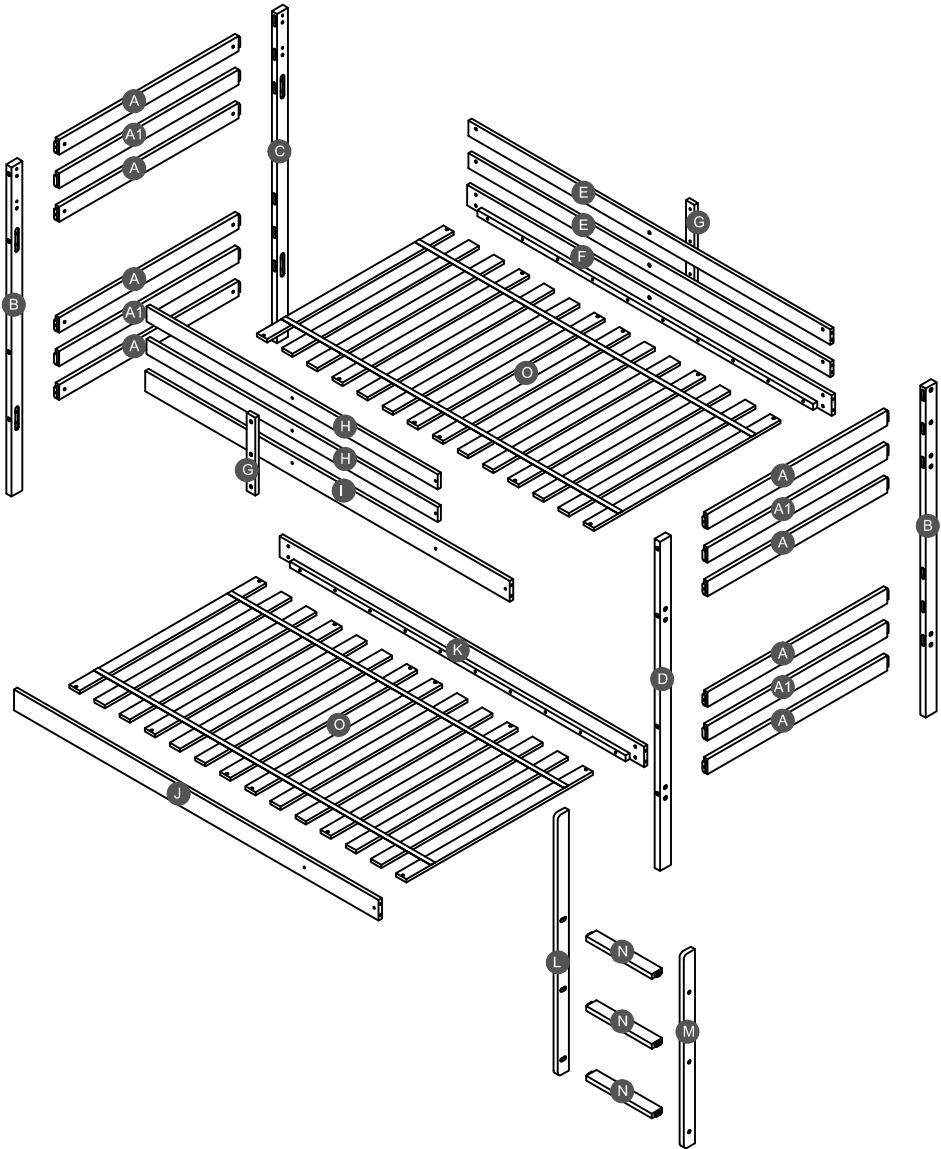

# Part List

**A** x8

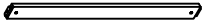

Horizontal bar HB&FB

**A1** x4

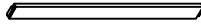

Horizontal bar HB&FB

**B** x2

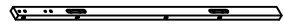

Leg (Left Front/Right Back)

**C** x1

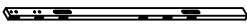

Leg left (Back)

**D** x1

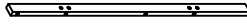

Leg right (Front)

**E** x2



Long guard rail

**F** x1



Upper side rail (Back)

**G** x2



Vertical guard rail

**H** x2



Guard rail (Front)

**I** x1



Upper side rail (Front)

**J** x1



Lower side rail (Front)

**K** x1



Lower side rail (Back)

**L** x1

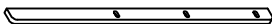

Left side ladder

**M** x1

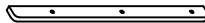

Right side ladder

**N** x3



Step ladder

**O** x2

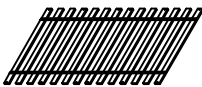

Slats

B

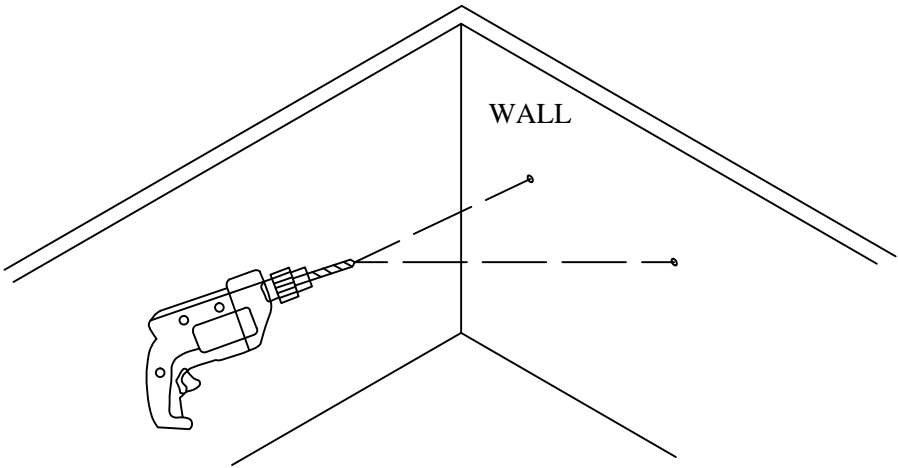

**EN:** Drill holes in the wall.

C

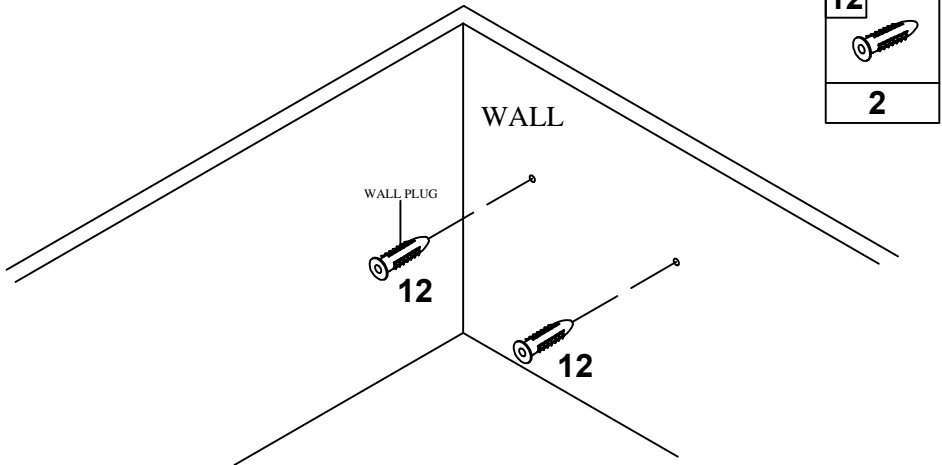

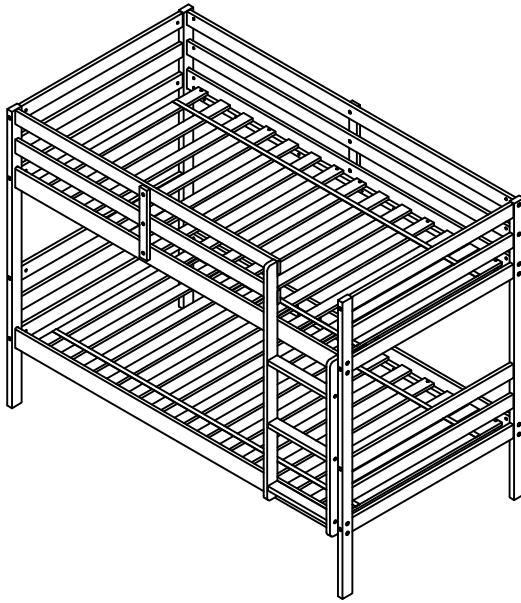

**EN:** To drive plastic anchor into the wall.



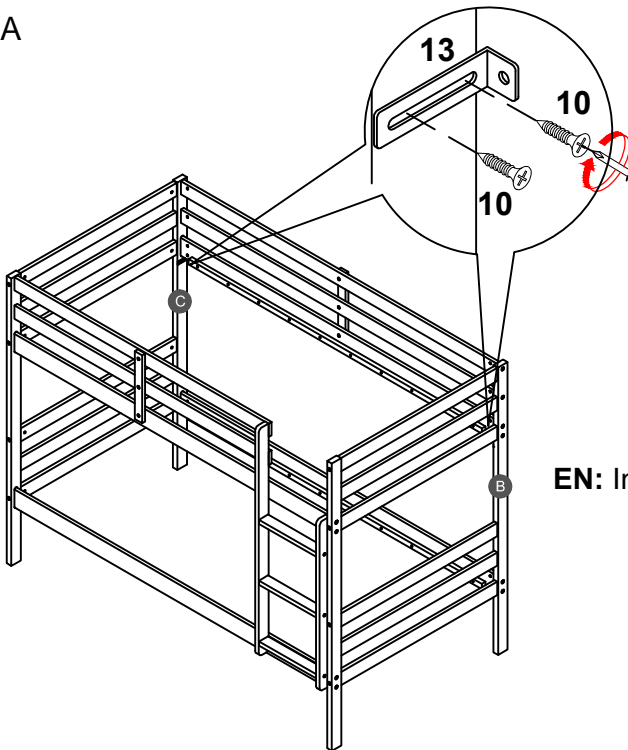





A

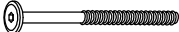
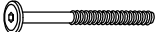
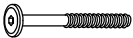

10	
4	
13	
2	

EN: Installing the Anti-Tip Bracket.

# Hardware List

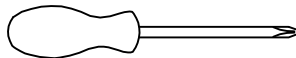

<b>1</b> x6 	<b>2</b> x16 	<b>3</b> x22 
$\text{Ø}10 \times 40\text{mm}$	$(\text{Ø}15)1/4 \times 100\text{mm}$	$(\text{Ø}15)1/4 \times 80\text{mm}$
Wood dowel	Hex-Head bolts	Hex-Head bolts
<b>4</b> x6 	<b>5</b> x6 	<b>6</b> x6 
$(\text{Ø}12)1/4 \times 60\text{mm}$	$(\text{Ø}12)1/4 \times 40\text{mm}$	$(\text{Ø}12)1/4 \times 30\text{mm}$
Hex-Head bolts	Hex-Head bolts	Hex-Head bolts
<b>7</b> x44 	<b>8</b> x24 	<b>9</b> x1 
$1/4 \times 15$ (9.5mm)	$\text{Ø}4 \times 30\text{mm}$	$(1/4 \text{")}4.5 \times 58\text{mm}$
Horizontal-Hole bolts	Screws	Allen key

**EN: ASSEMBLY TOOLS REQUIRED ( NOT INCLUDED )**

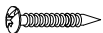

**EN: PLEASE BE CAREFUL DO NOT DAMAGE THE HOLE POSITION WHEN YOU USE POWER TOOLS !**

# Hardware List

<b>10</b> x4 	<b>11</b> x2 	<b>12</b> x2 
Ø4*25mm	Ø4*38mm	Ø9*32mm
Screws	Screws	Plastic anchor

<b>13</b> x2 
58*16*16*(1.5mm)
Metal bracket

**EN: ASSEMBLY TOOLS REQUIRED ( NOT INCLUDED )**

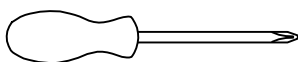

**EN: PLEASE BE CAREFUL DO NOT DAMAGE THE HOLE POSITION WHEN YOU USE POWER TOOLS !**

06:

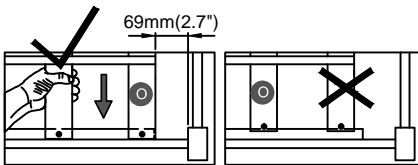
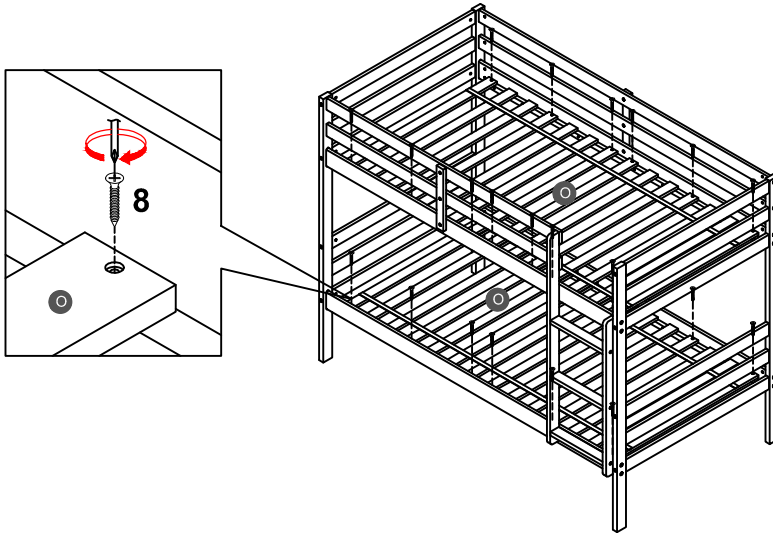
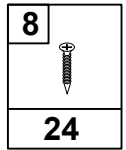



**EN: Note:** Do not lock the screws of the bed slats to the outermost edge of the bed slats, you need to leave a certain space at the edges, otherwise it will cause the board to break.

Do not lock the bed slats on the edge of the wood, please hold firmly before screwing , hold it in place with one hand, then lock the screw.

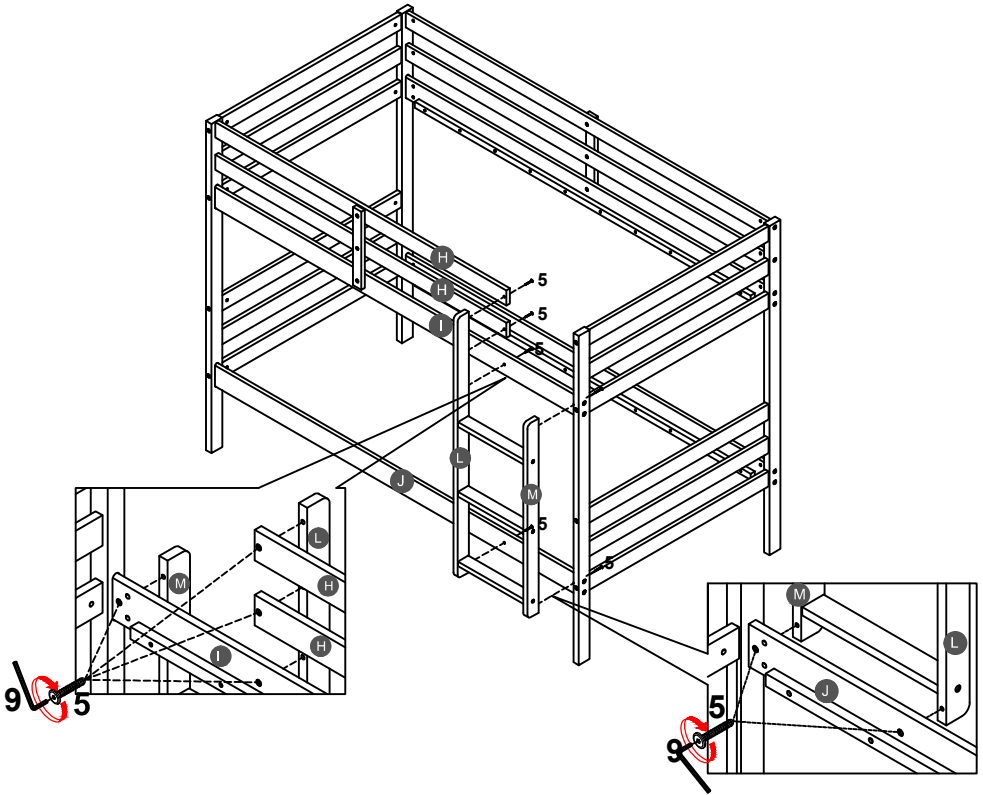
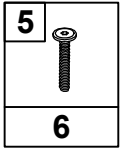
05:



01:



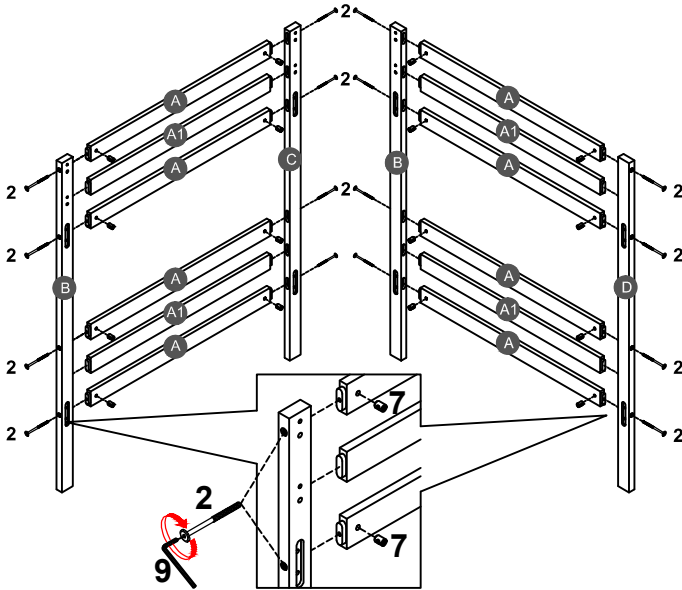

2		7	
16		16	

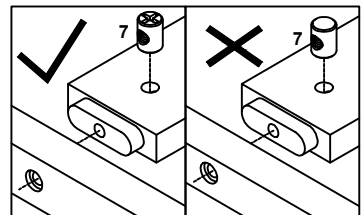

**EN: Note:** Part 7 will face up with the "x" mark on it, otherwise it cannot be tightened.





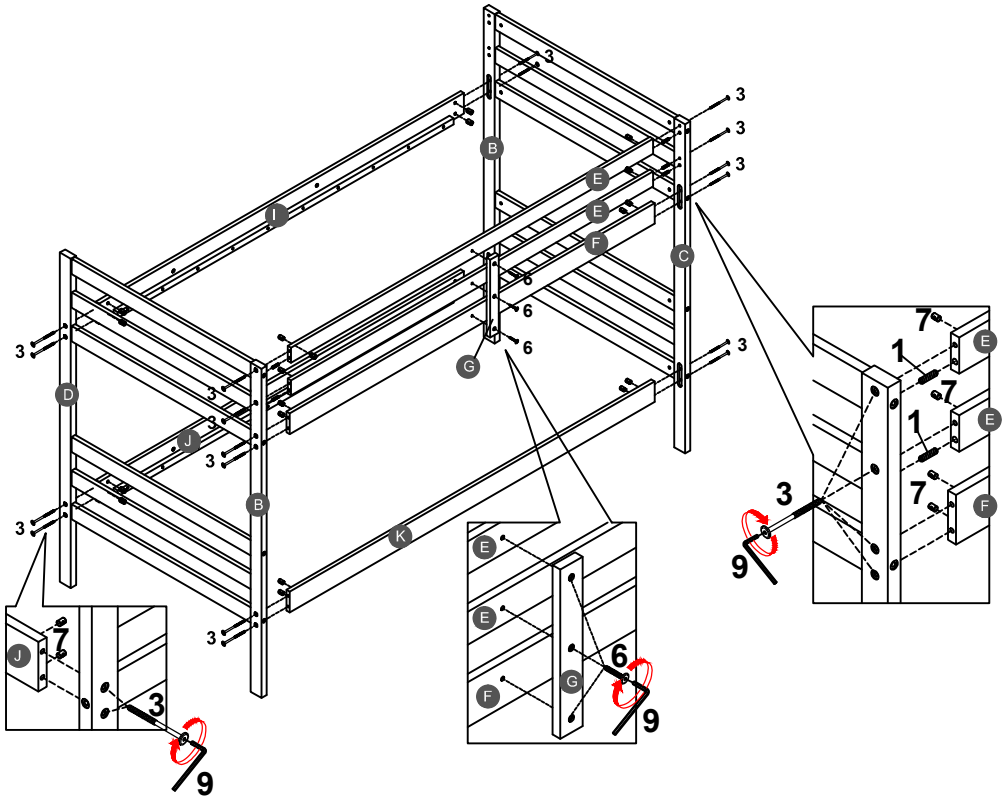

02:

1		3		6		7	
4		20		3		20	



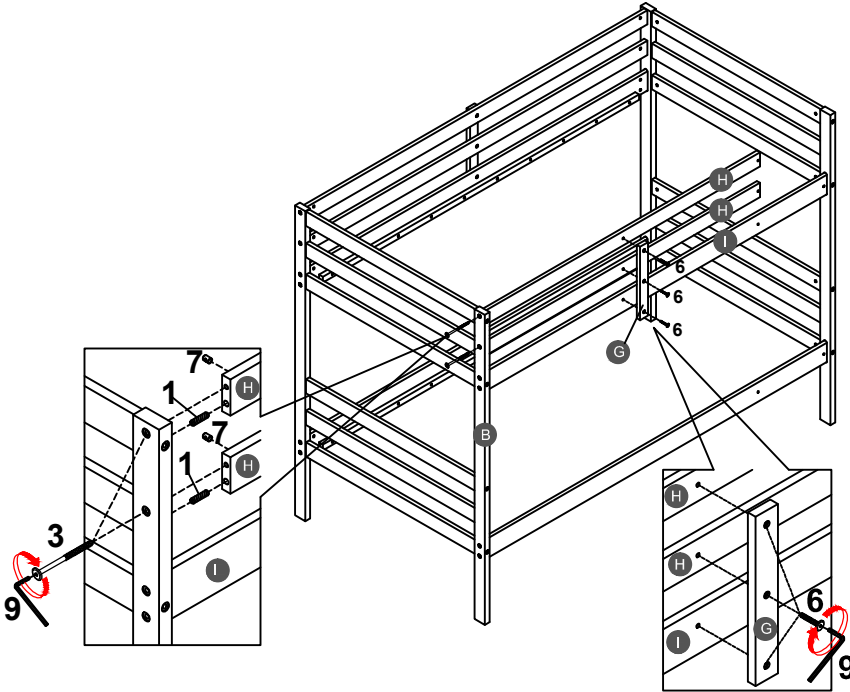

03:

1		3		6		7	
2		2		3		2	



04:

4		7	
6		6	

