



Freestanding Bath Maintenance & Instructions



Please retain this manual after installation for future reference and maintenance

Product must be installed in compliance with relevant Water Bylaws

The product is CUPC certified

Original certification model code: D-8362-170 File No. 7974

IMPORTANT:

- * Two people are required for installation
- * Freestanding bath is not designed to take weight on the rim. Do not sit or stand on the bath rim

TOOLS REQUIRED FOR INSTALLATION



Spirit Level



Wrench

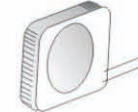

Tape



Marking Pencil



Silicone Gun

Step 1

Adjust the bath feet until the bath base is 3mm above the floor;

This can be done by turning the feet bars accordingly;

Then use wrench to tighten the nuts on the bars

See figure 1

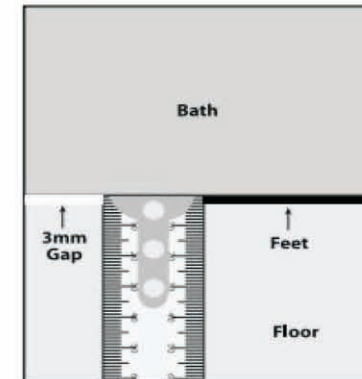

Figure 1

Feet set at 3mm above the floor

Step 2

Mark the floor with the outline of the bath, at the final installation position with the marking pencil



Step 3

Carefully tilt bath on its side and use flexible connector to connect waste outlet to the trap as illustrated on figure 2

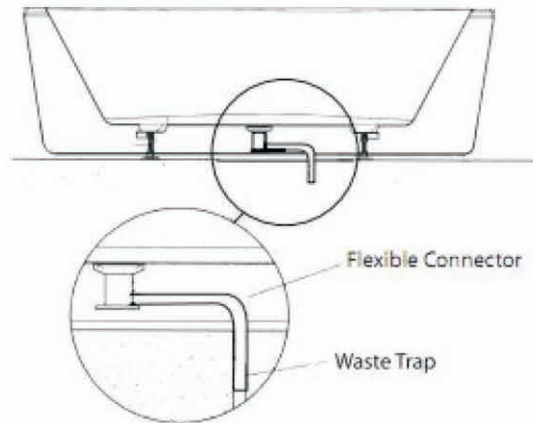

Figure 2

Flexible connector installation

***Flexible connector and waste trap are not supplied

Step 4

Position bath on the floor marking as marked on step 2, make sure that flexible connector is not kinked upward on installation as this will result in drainage issue

Step 5

Apply silicone around the base surrounding of the bath, see figure 3



Figure 3

*** Do not use within 24 hours to let the silicone fully cure

Cleaning & Maintenance:

- A) To preserve the polished surface, after using your bath, clean with soft cloth and warm soapy water to wash away any body oils or soap residue that forms a ring tide mark
- B) Do not use powders, pastes, crème cleaners, thinners, window cleaning sprays or dry cleaning liquid, etc.
- C) Stubborn marks or fine scratches may be polished out with Brasso
- D) When coloured essentials oils are used, first test that the colour won't stain your bath. Always add oils into a bath full of water. Never pour them into a empty bath

RECEIVING YOUR BATH

- A) Unpack and check for damage.
After receiving your bath, please unpack and remove all covering, checking whether there is any damages. Repack the bath if it is not being immediately installed. It will be rejected any claim for damage if not notified in a timely manner.
- B) Protect your bath.
Before commencing installation, ensure the bath is completely protected, leave covering in place until the bathroom is complete. Scratches and cracks incurred during installation are not covered by the warranty

WATER TESTING

- A) **Water test your bath prior to enclosing to ensure it drains correctly as no claims for non-draining baths will be valid after enclosing or tiling has been done**
- B) Water test overflow pipe and waste to ensure they are not leaking

REPAIRS

Scratches and cigarette burns can be improved with 1200 grade wet and dry sandpaper then repolished with Brasso polishing compound. Always polish scratch in a circular movement