

dh

Model: _____

Lot No: _____

Date of Purchased: _____

SWOOP CHAIR

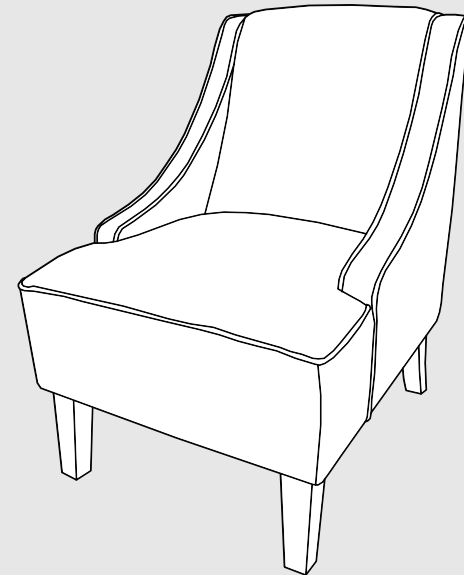

ADULT ASSEMBLY REQUIRED

If you are missing any parts or have any questions regarding assembly, do not return this item to the retailers store. Please call our toll-free customer service number and have this assembly manual open to the parts list ready to provide the model name, and part name or number.

Customer Service

1-877-864-5752

8:30 AM PST - 4:30 PM PST (Monday - Friday)

Website: www.dwellhom.com

Missing Parts: parts@dwellhom.com

Warranty Information: www.dwellhom.com/warranty



WARNING: This product may contain small components, please ensure they are kept away from small children.

PARTS AND HARDWARE

Avoid using sharp objects such as a knife to cut open packing as you may accidentally damage the upholstery.

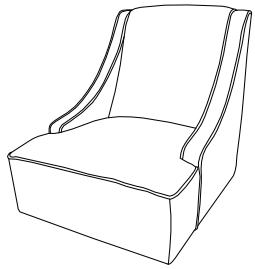

A. Chair Frame

1x



B. Front Leg

2x

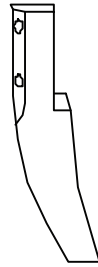

C. Rear Leg

2x

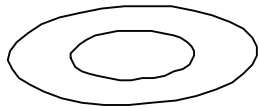

D. Washer

4x

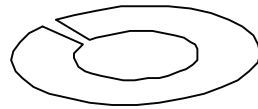

E. Lock Washer

4x

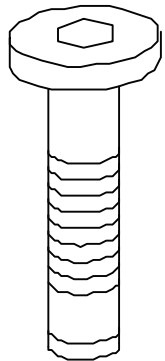

F. Bolt

4x

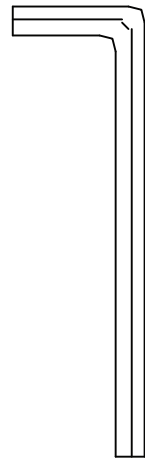

G. Allen Key

1x

ASSEMBLY INSTRUCTIONS

Do not fully tighten bolts until assembly is complete.

1

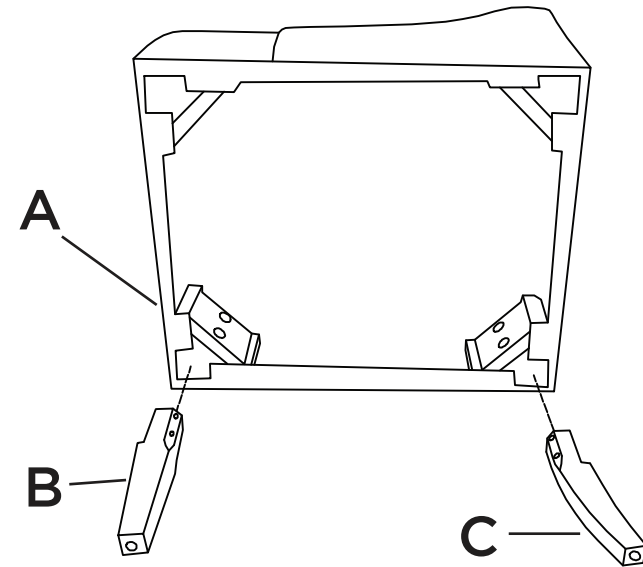

2

