

Venetia™

Club Chair

Model: OP-ALCLB2-VEN

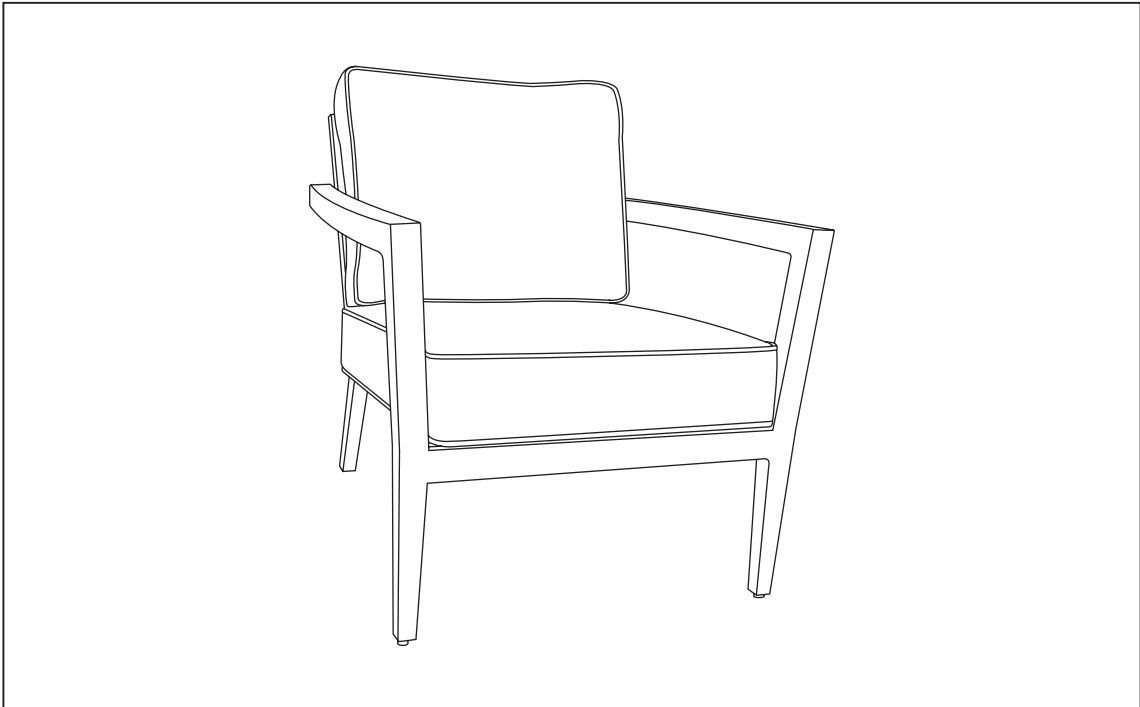



ASSEMBLY INSTRUCTIONS

**IMPORTANT, RETAIN FOR FUTURE REFERENCE.
READ CAREFULLY.**

For assistance with assembly or customer service,
call 1-877-924-2090 (English) Monday-Friday, 8 a.m. to 5 p.m. Mountain
Time, North America. Email: customerservice@rstbrands.com or visit
our website at www.rstbrands.com

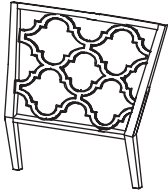
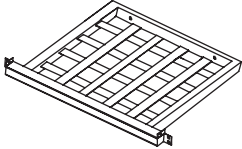
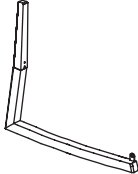
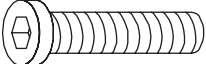
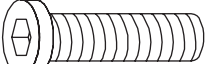

PARTS LIST

NO	PICTURE	PART DESCRIPTION	QTY.
A		Chair back	1
B		Chair seat	1
C		Left and right arms	2
D		Bolt (M6 x 20)	8
E		Bolt (M6 x 35)	2
F		Washer (13*6.5*1.0)	10
G		Allen wrench #4	1

Step 1.

CONNECT CHAIR BACK TO CHAIR SEAT - Connect the chair back (A) to the chair seat (B) using washers (F), bolts (E), and allen wrench (G).

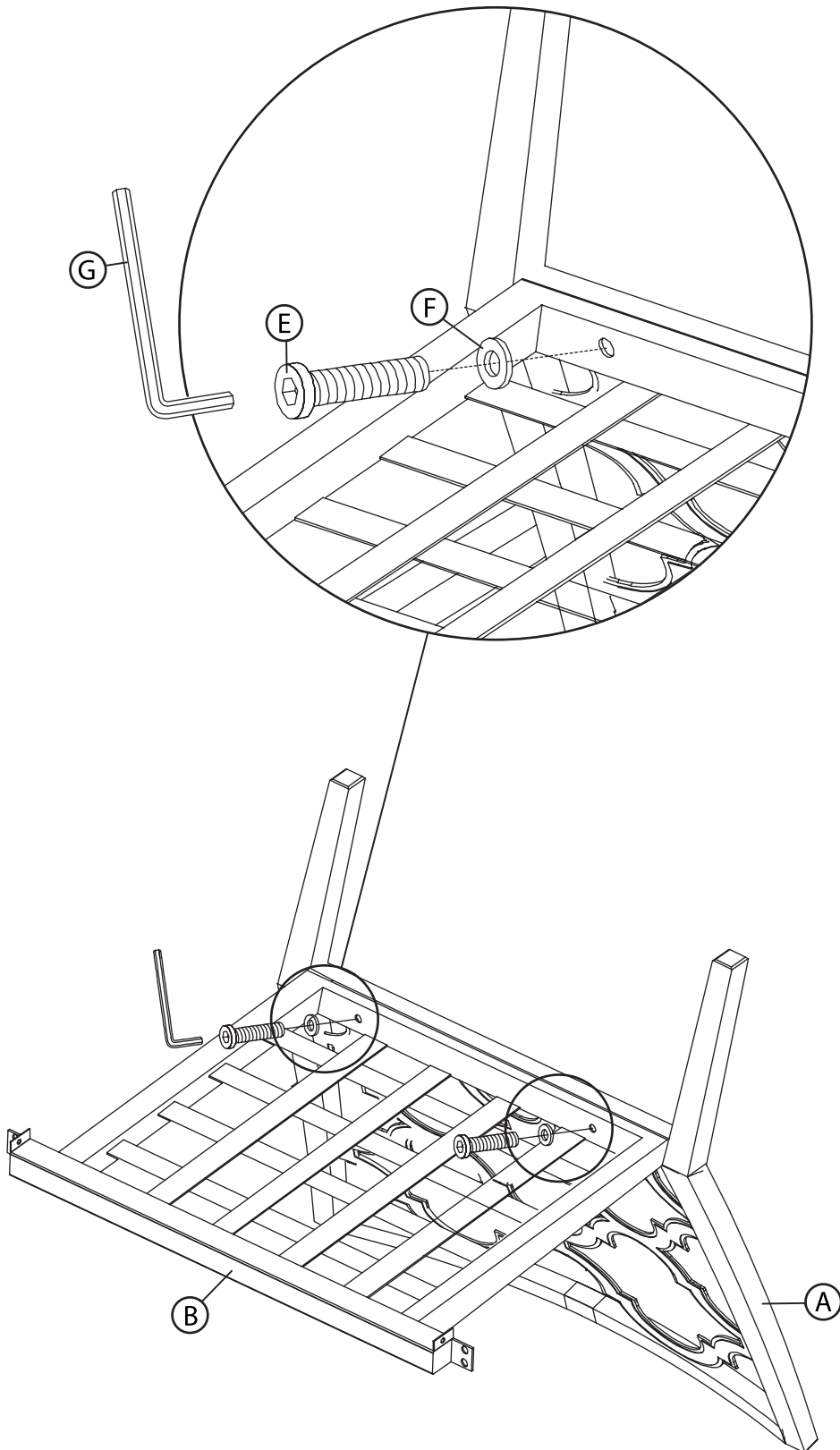

Step 2.

ATTACH LEFT AND RIGHT ARMS - Attach the left and right arms (C) to the assembled chair back (A) and chair seat (B) using washers (F), bolts (D), and allen wrench (G).

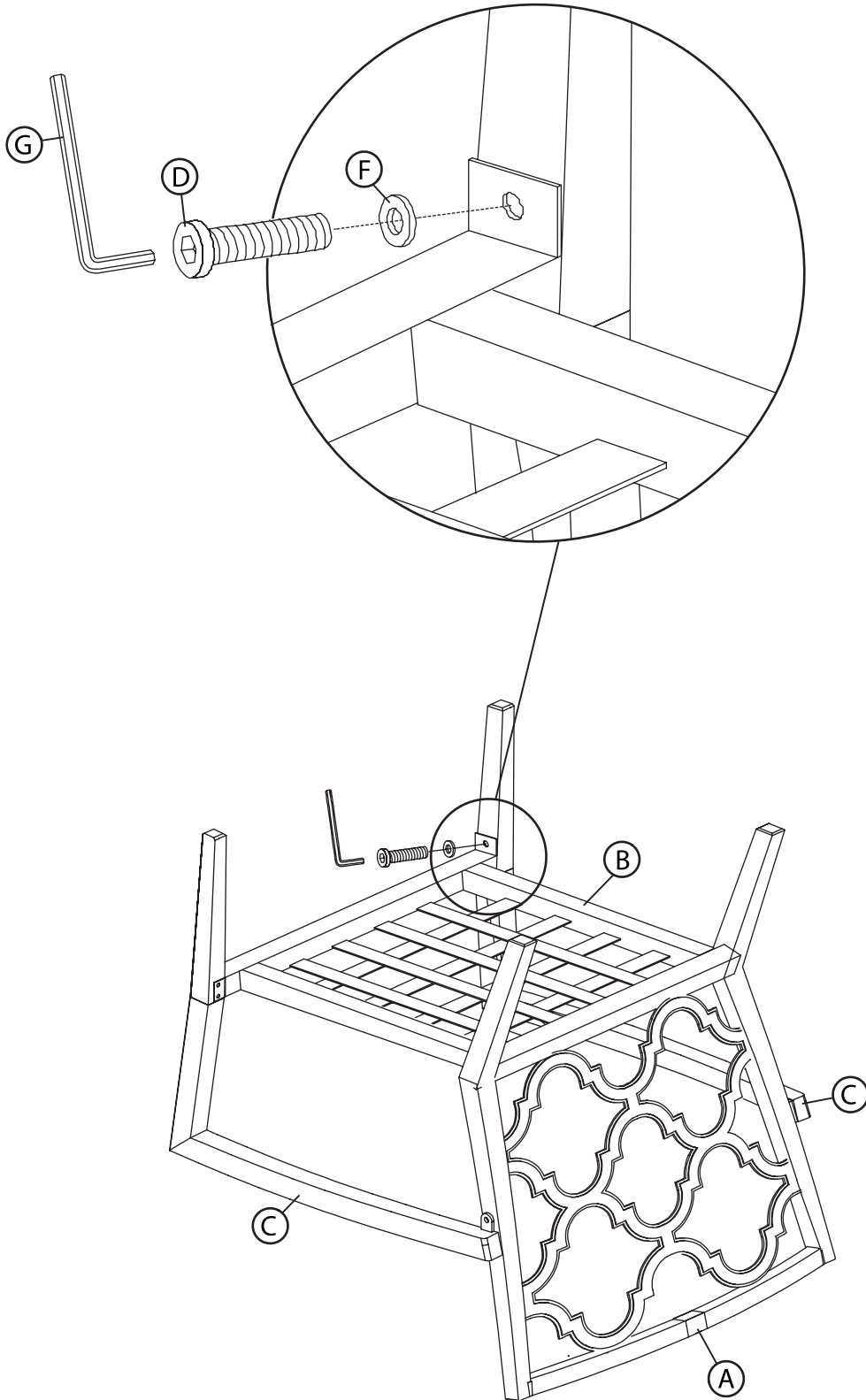

Care and Maintenance

All outdoor furniture is subject to UV rays and weather elements. In order to keep your furniture as long lasting and vibrant as possible, we advise using furniture covers or storing the furniture when not in use. For more information about the materials used to make our furniture please visit www.rstbrands.com/details-landing

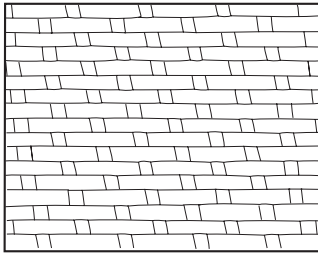

WICKER

Simply washing your wicker with a mild detergent and protecting it as much as possible by covering and or storing it when not in use for long periods of time is sufficient.

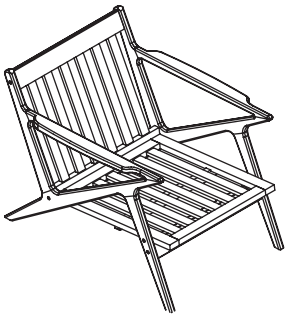

WOOD FRAMES

Make sure all surfaces are protected from heat and liquids. Wipe up spills immediately and do not place furniture next to a heat source such as radiators or fires. All timber surfaces may change color. Spray polishes are best to avoid as they contain silicones which may spoil the surface by building up overtime. Check bolts and screws regularly and tighten when necessary.

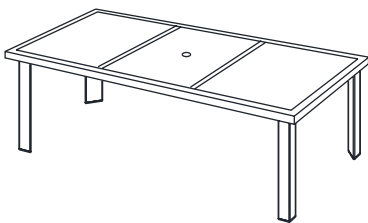

STONE TOPS/ TABLE TOPS

Spills should be wiped up quickly to avoid any staining on the surface. Regular cleaning with mild soap and water with a sponge or soft scrub brush is all that is required. Storing or covering your natural stone top when not in use for extended periods of time is recommended.

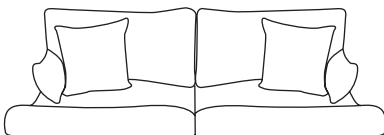

FABRICS

Wipe off spills with a cloth and water. RST Brands uses Sunbrella® fabrics designed to protect and last for several years. Sunbrella fabrics are treated with a proprietary water and stain repellent. If needed to revive fabrics Glen Raven® recommends 303® Fabric Guard™. For more information visit www.303products.com and follow instructions on the container.