

# ASSEMBLY INSTRUCTION



## Push Back Chair



Legs are stored in the box, please take out for assembly.

Note: Do not use power tools for assembly. Power tools increase the risk of over tightening which lead to splitting or cracking the wood

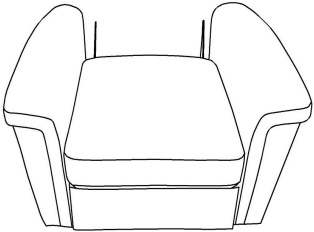
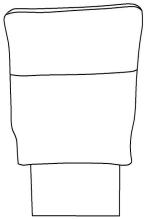
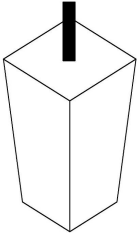
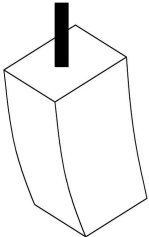
### Component list .

Label	Picture	Description	QTY(pc)
A		Seat Frame	1
B		Back Rest	1
C		Wooden Front Leg φ3.5"*5.5"	2
D		Wooden Rear Leg 1.75"*2.25"*5.5"	2
E		Plastic Gasket	4

## Step #1

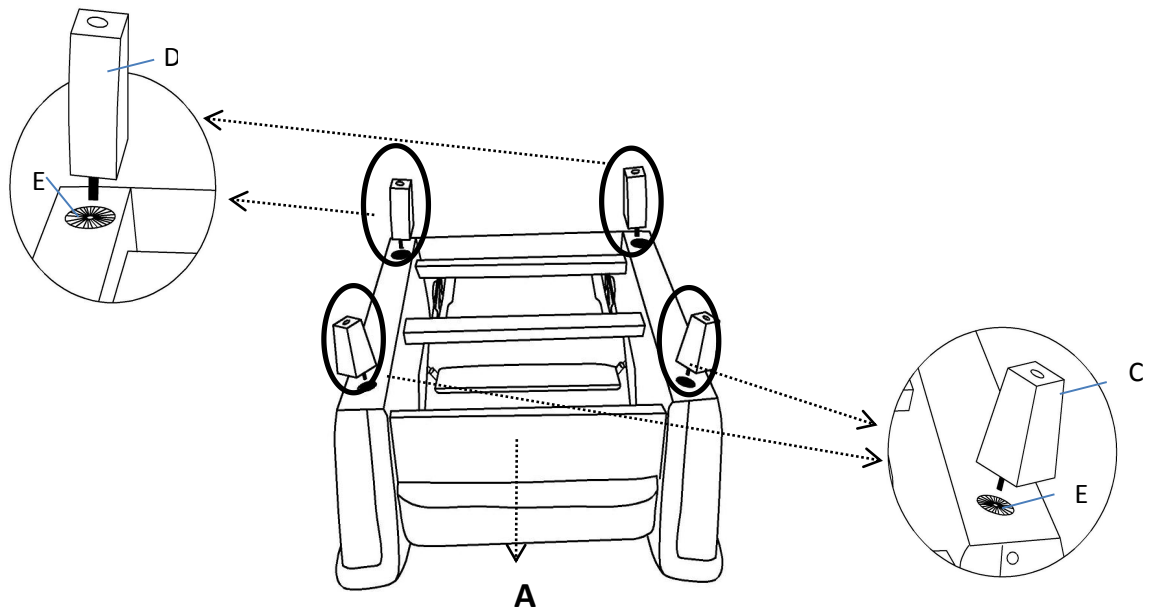

## Step #2

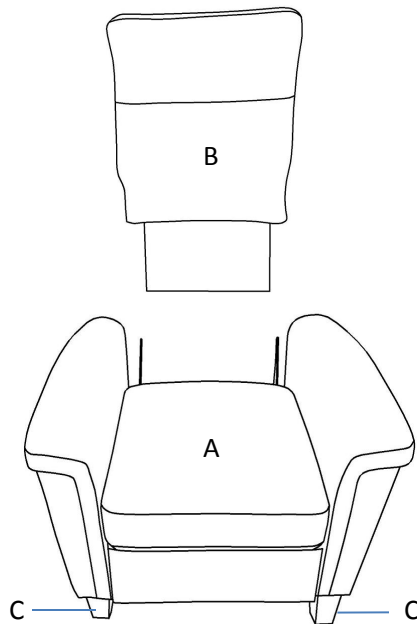

## Care Instruction for Polyester Furniture:

In order to maintain the original appearance of your Polyester furniture, please follow below simple care procedures:

- Avoid exposing furniture directly to sunlight or heating and air conditioning outlets. Sunlight and or exposure to heating and air conditioning outlets will fade/damage Polyester.
- Vacuum or wipe with a soft cloth to remove dust.



For item use on wooden floor, hard surfaces or carpets, it is recommended to install protective pads under all legs and supports to avoid/prevent from damages/scratches and discoloration.