

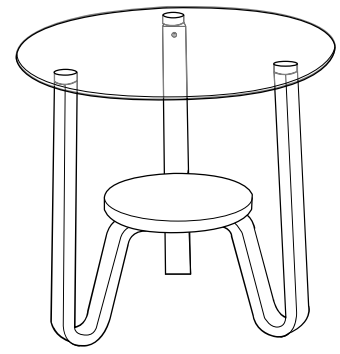

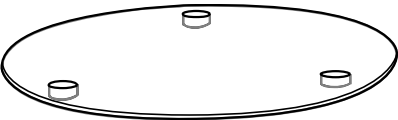

# END TABLE

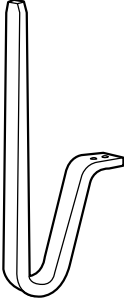
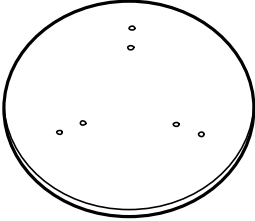
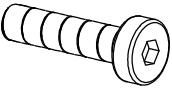
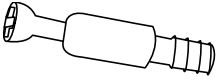

## ASSEMBLY INSTRUCTIONS

1	2	3	
 <p><b>GLASS TOP</b> 1PC</p>	 <p><b>BENTWOOD LEG</b> 3PCS</p>	 <p><b>SHELF</b> 1PC</p>	
<b>A</b>	<b>B</b>	<b>C</b>	<b>D</b>
 <p><b>BOLT 1/4"x7/8"</b> 6PCS</p>	 <p><b>CONNECTING BOLT</b> <b>THREAD M6</b> 3PCS</p>	 <p><b>CONNECTOR</b> <b>HOUSING M6</b> 3PCS</p>	 <p><b>WASHER</b> 6PCS</p>
<b>E</b>	<b>F</b>		
 <p><b>ALLEN KEY</b> 1PC</p>	 <p><b>STICKER</b> 3PCS</p>		

**\*\*\* Do not tighten screws & bolts until the entire unit is completely assembled. \*\*\***

\*Please put all parts on a soft surface to prevent scratches.

Attach bentwood leg (2) to glass top (1) by using connecting bolt thread (B) and connector housing (C) as shown.

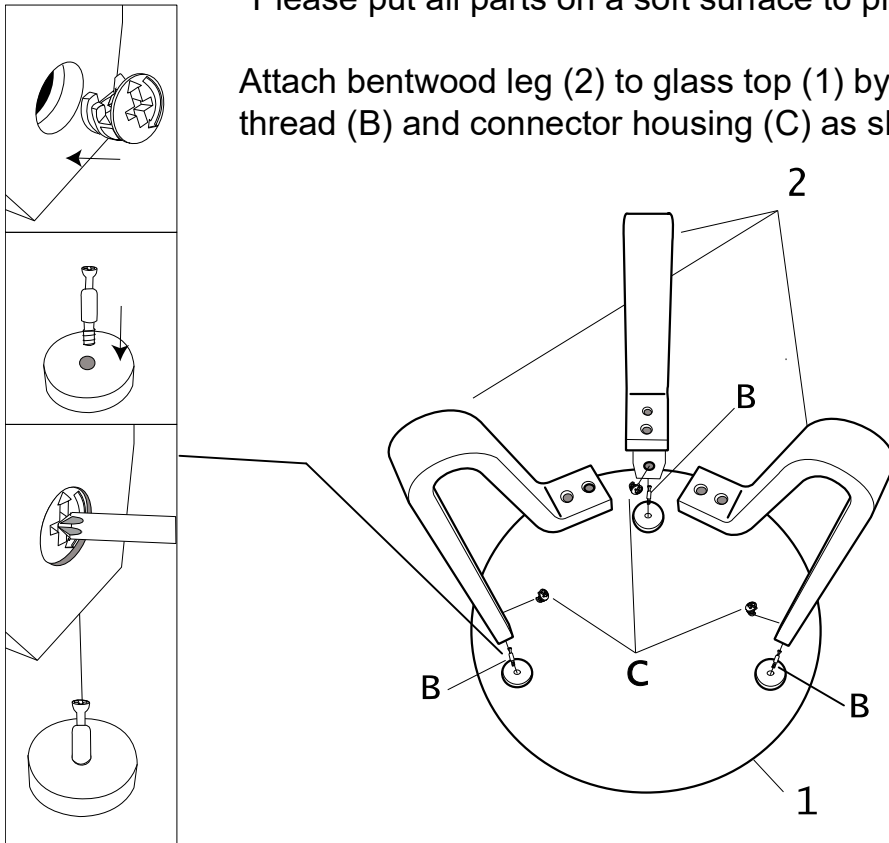

Attach shelf (3) to bentwood leg (2) by using bolt (A) and washer (D) as shown.

Tighten all bolts and carefully turn the assembled unit upright. Finally, use the stickers (F) to cover the connector.

