

---

# Ceiling Fan With Light User Manual

NO.7026

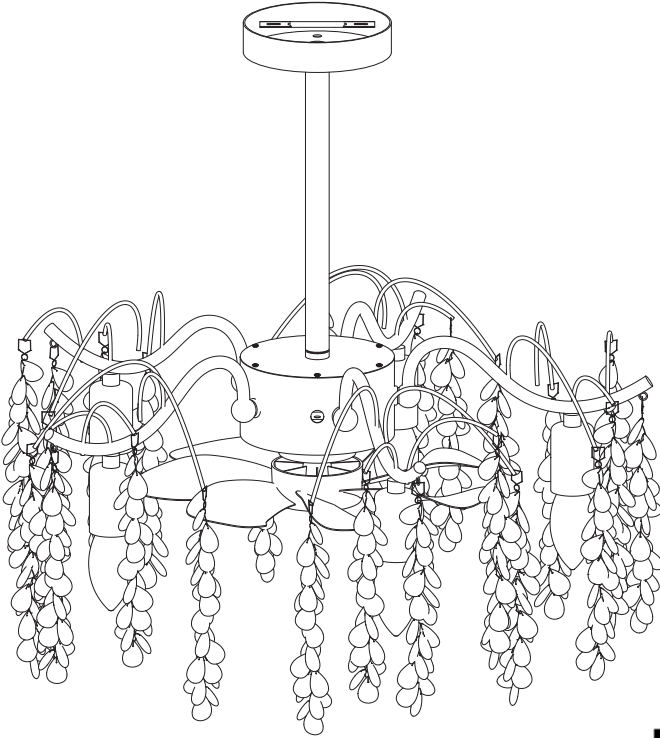

Please Scan the QR code to watch the installation video.  
If you have any questions, please feel free to contact us  
through the order interface.

# Notice Before Installation

1. Not compatible with a dimmer switch. Please use a regular ON/OFF wall button switch or the included remote.
2. Contact us via the order page if there are any damaged, missing parts, or other questions. (Reply within 6 hours / Free Replacement / Partial Refund)
3. Although the installation is simple, for safety reasons, we recommend having a professional electrician complete the installation.
4. Please scan the QR code to watch the installation video.



Scan the QR code to watch  
the installation video

## Warning!

- 1) Please have the product installed by a professional.
- 2) The voltage available is AC110V AC127V AC220V AC85-265V only.
- 3) Do not install the lighting fixture in moist or damp conditions.
- 4) Always switch off the power before cleaning the lighting fixture.
- 5) Keep the lighting fixture away from acidic and corrosive materials.

# Package includes

Please check if the package contains the following parts:

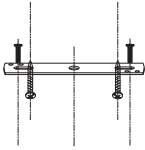

Hanging bracket



screw drive

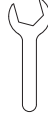

M10 wrench



M10 anti-backout screw

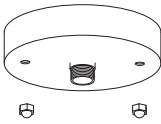

Canopy



Paper tube



Hook



Sloped ceiling adapter



M3 screw



Down rod



Motor housing cover

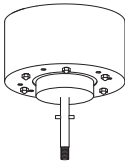

Motor housing

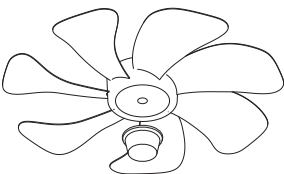

Blades

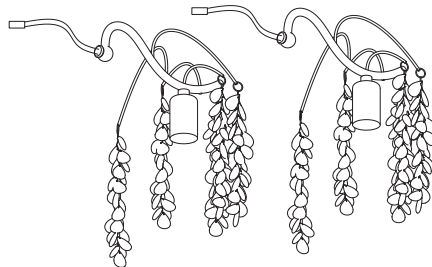
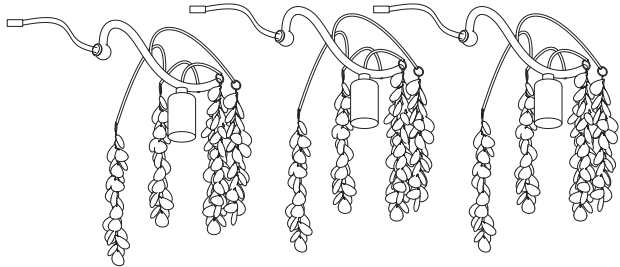

Lamp body arms with crystal accessories (5 Pcs)

# How to assemble ?

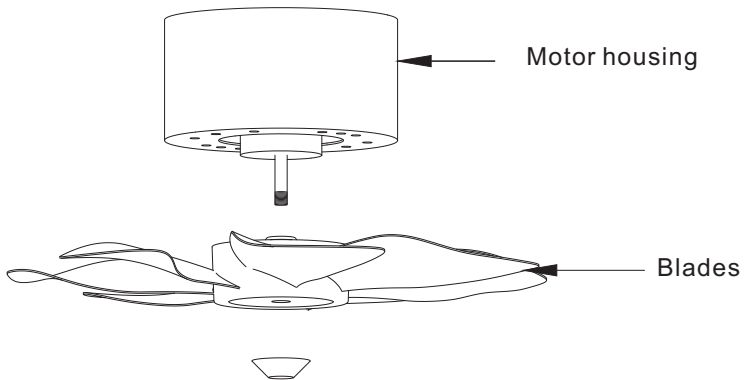

Step 1: Install the blades, then rotate the blade cap anticlockwise to fasten it tightly.

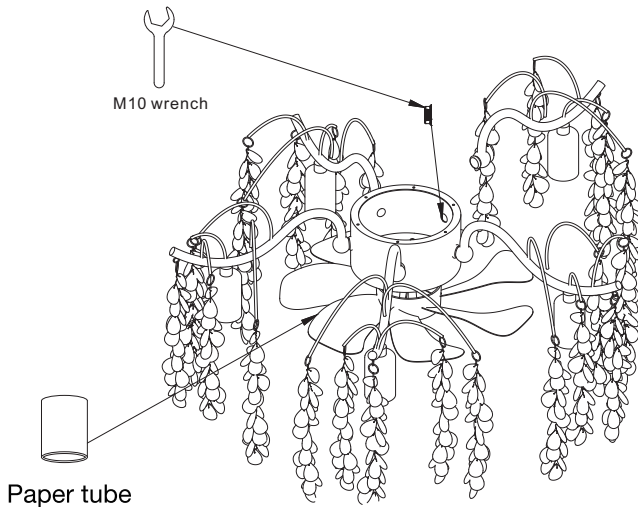

Step2: Place the paper tube under the fan blades, secure the lamp arms through the holes on the side of the motor housing, adjust the arms to the same level, then tighten them securely with the M10 anti-backout screw nuts and M10 wrench.

# How to assemble ?

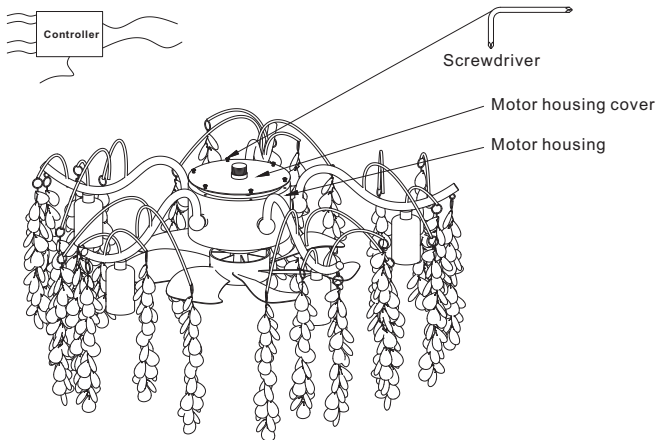

Step3: Pass the input line of the controller through the hole in the motor housing cover, then connect it to the power cable, and securely screw the motor housing cover to the motor housing.

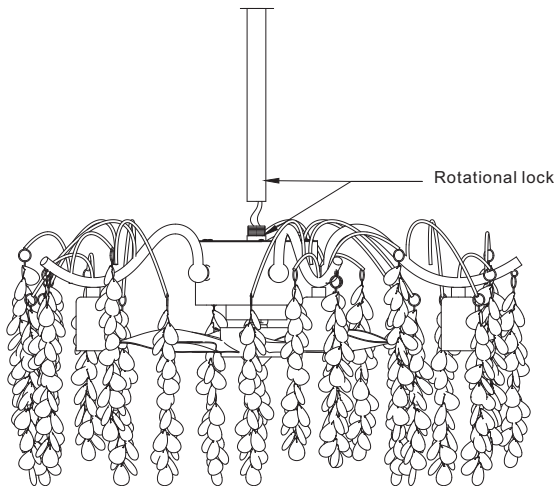

Step4: Pass the lamp power line through the center downrod, then rotate it to securely fasten it to the one-end screw connector located on top of the motor housing cover.

# How to assemble ?

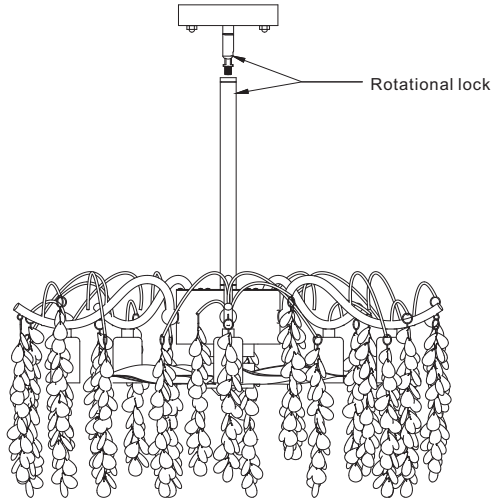

Step5: Rotate to securely fasten the lamp body's center downrod to the canopy. (Usage of the sloped ceiling adaptor: If the ceiling is sloped, you can choose to use the sloped ceiling adaptor to adjust the angle.)

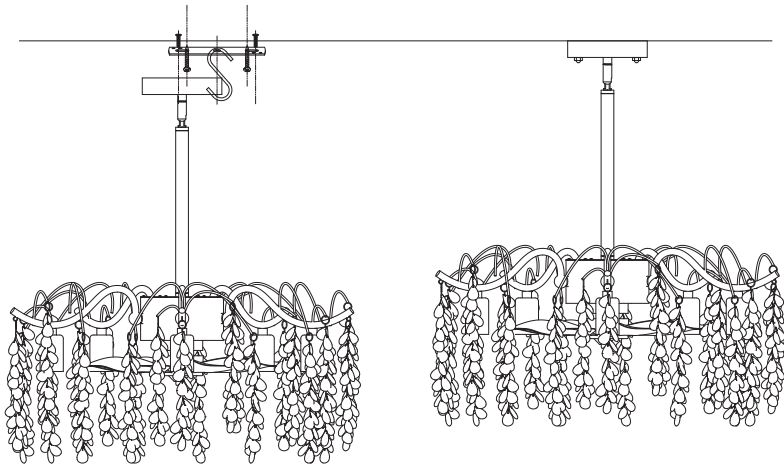

Step6: Secure the hanging bracket to the ceiling, use a hook to assist with wiring the lamp body, and then install the lamp onto the ceiling.

# How about a sloping ceiling?

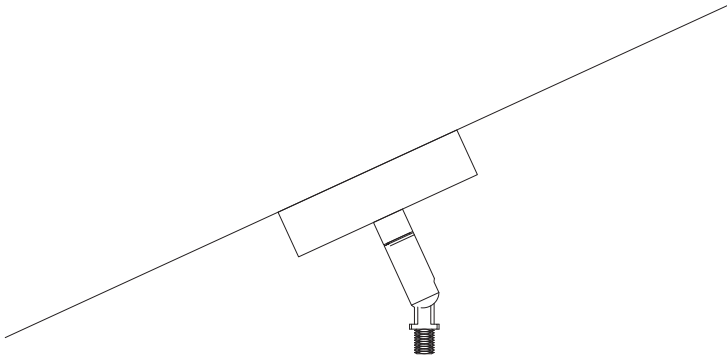

If there is a sloping ceiling, please use the sloped ceiling adapter to adjust the angle.

## Remote Control Manual

