

**ASSEMBLY INSTRUCTION**  
**SKU CODE: (N701P261990)**  
**INSTRUCTION DE MONTAGE**  
**CODE SKU : (N701P261990)**

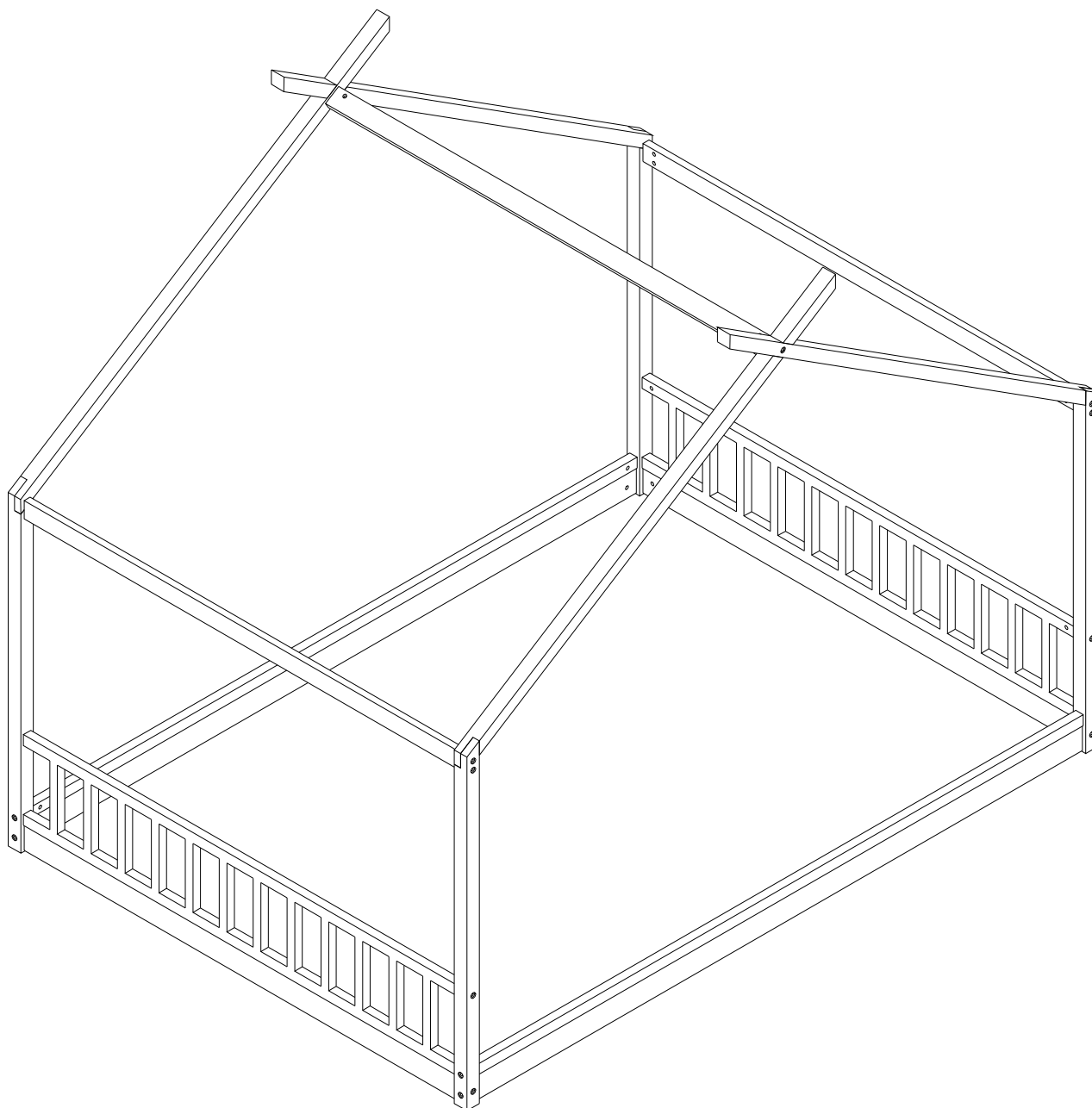

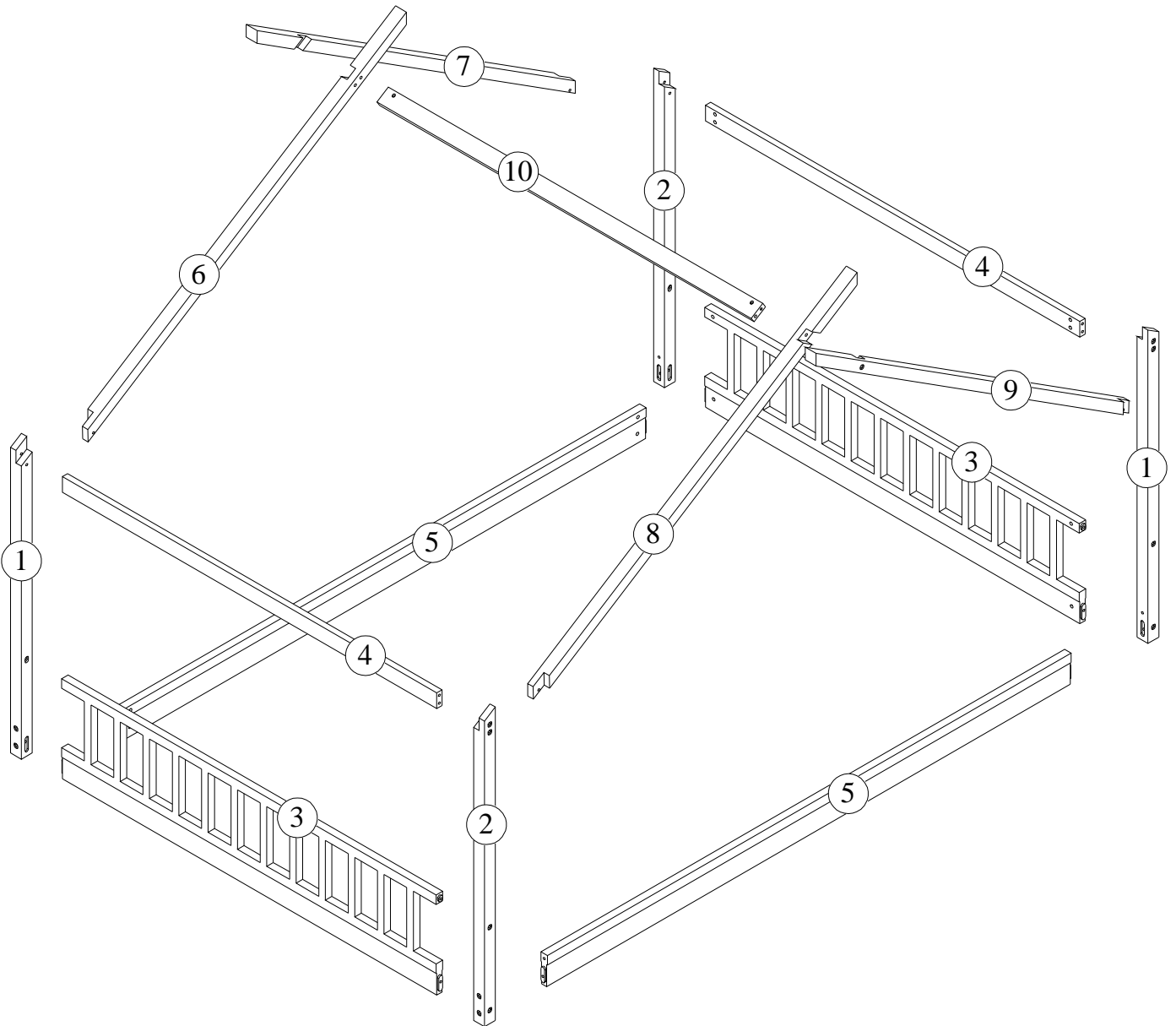





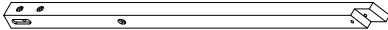

# ASSEMBLY INSTRUCTION

## INSTRUCTION DE MONTAGE

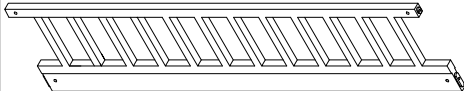
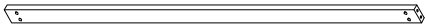

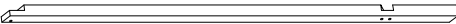

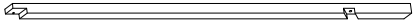

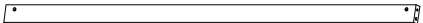
# Part List (N701P261990)

## Liste des pièces (N701P261990)

<div style="border: 1px solid black; width: 40px; height: 40px; display: flex; align-items: center; justify-content: center; margin-bottom: 5px;">1</div>  <p style="text-align: center; margin-top: 5px;">Front Left Back Right Leg-2pcs Jambe avant gauche arrière droite-2pcs</p>	<div style="border: 1px solid black; width: 40px; height: 40px; display: flex; align-items: center; justify-content: center; margin-bottom: 5px;">2</div>  <p style="text-align: center; margin-top: 5px;">Front Right Back Left Leg-2pcs Jambe avant droite, arrière gauche-2pcs</p>	<div style="border: 1px solid black; width: 40px; height: 40px; display: flex; align-items: center; justify-content: center; margin-bottom: 5px;">3</div>  <p style="text-align: center; margin-top: 5px;">Hip Frame-2pcs Cadre de hanche-2pcs</p>
<div style="border: 1px solid black; width: 40px; height: 40px; display: flex; align-items: center; justify-content: center; margin-bottom: 5px;">4</div>  <p style="text-align: center; margin-top: 5px;">Top Bar-2pcs Barre supérieure-2pcs</p>	<div style="border: 1px solid black; width: 40px; height: 40px; display: flex; align-items: center; justify-content: center; margin-bottom: 5px;">5</div>  <p style="text-align: center; margin-top: 5px;">Bed Shoulder-2pcs Épaule du lit-2pcs</p>	<div style="border: 1px solid black; width: 40px; height: 40px; display: flex; align-items: center; justify-content: center; margin-bottom: 5px;">6</div>  <p style="text-align: center; margin-top: 5px;">Puzzle(Left-back)-1pc Puzzle (Arrière gauche)-1pc</p>
<div style="border: 1px solid black; width: 40px; height: 40px; display: flex; align-items: center; justify-content: center; margin-bottom: 5px;">7</div>  <p style="text-align: center; margin-top: 5px;">Puzzle(Right-back)-1pc Puzzle (Arrière droit)-1pc</p>	<div style="border: 1px solid black; width: 40px; height: 40px; display: flex; align-items: center; justify-content: center; margin-bottom: 5px;">8</div>  <p style="text-align: center; margin-top: 5px;">Puzzle(Front-Left)-1pc Puzzle (devant gauche)-1pc</p>	<div style="border: 1px solid black; width: 40px; height: 40px; display: flex; align-items: center; justify-content: center; margin-bottom: 5px;">9</div>  <p style="text-align: center; margin-top: 5px;">Puzzle(Front-Right)-1pc Puzzle (devant à droite)-1pc</p>
<div style="border: 1px solid black; width: 40px; height: 40px; display: flex; align-items: center; justify-content: center; margin-bottom: 5px;">10</div>  <p style="text-align: center; margin-top: 5px;">Roof Cross Bar-1pc Barre transversale de toit-1pc</p>		

# Hardware List (N701P261990)

## Liste du matériel (N701P261990)



<b>A</b>  Ø8 x 30 mm Wood dowel-2pcs Cheville en bois-2pcs	<b>B</b>  Ø1/4" x 80 mm Hex-Head bolts-26pcs Boulons à tête hexagonale-26pcs	<b>C</b>  Ø1/4" x 12 mm Horizontal-Hole bolts-26pcs Boulons à trou horizontal-26pcs
<b>D</b>  Allen Key-1pc Clé Allen-1pc		

Please sort out all parts before you begin to assembly the item. This is to make sure you always use the correct part.  
Veuillez trier toutes les pièces avant de commencer à assembler l'article. Cela permet de s'assurer que vous utilisez toujours la bonne pièce.

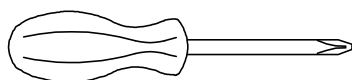
ASSEMBLY TOOLS REQUIRED ( NOT INCLUDED )  
OUTILS D'ASSEMBLAGE REQUIS (NON INCLUS)



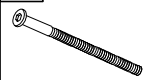

STEP1:  
ÉTAPE 1:

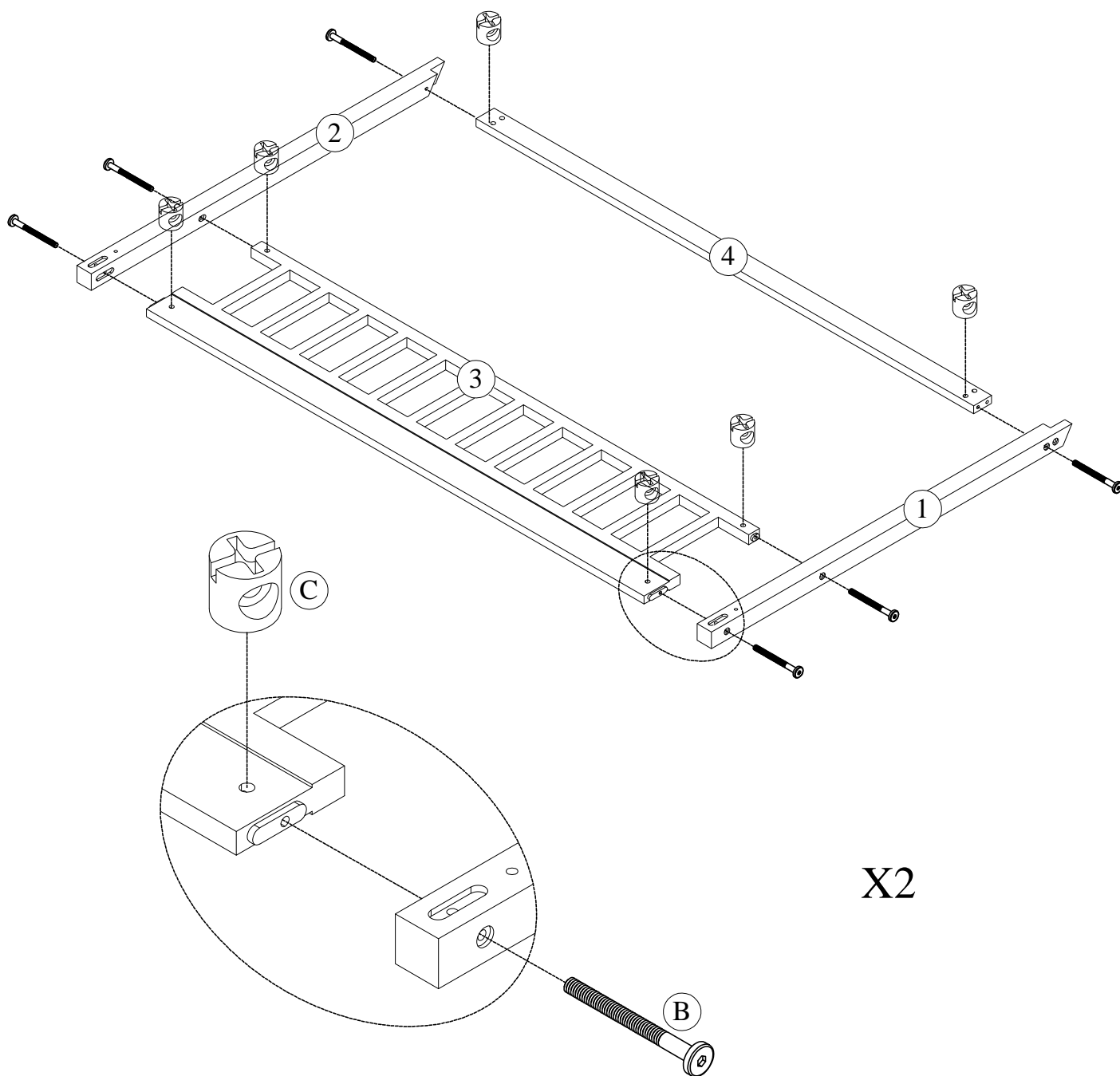
<b>B</b> 	<b>C</b> 
12PCS	12PCS



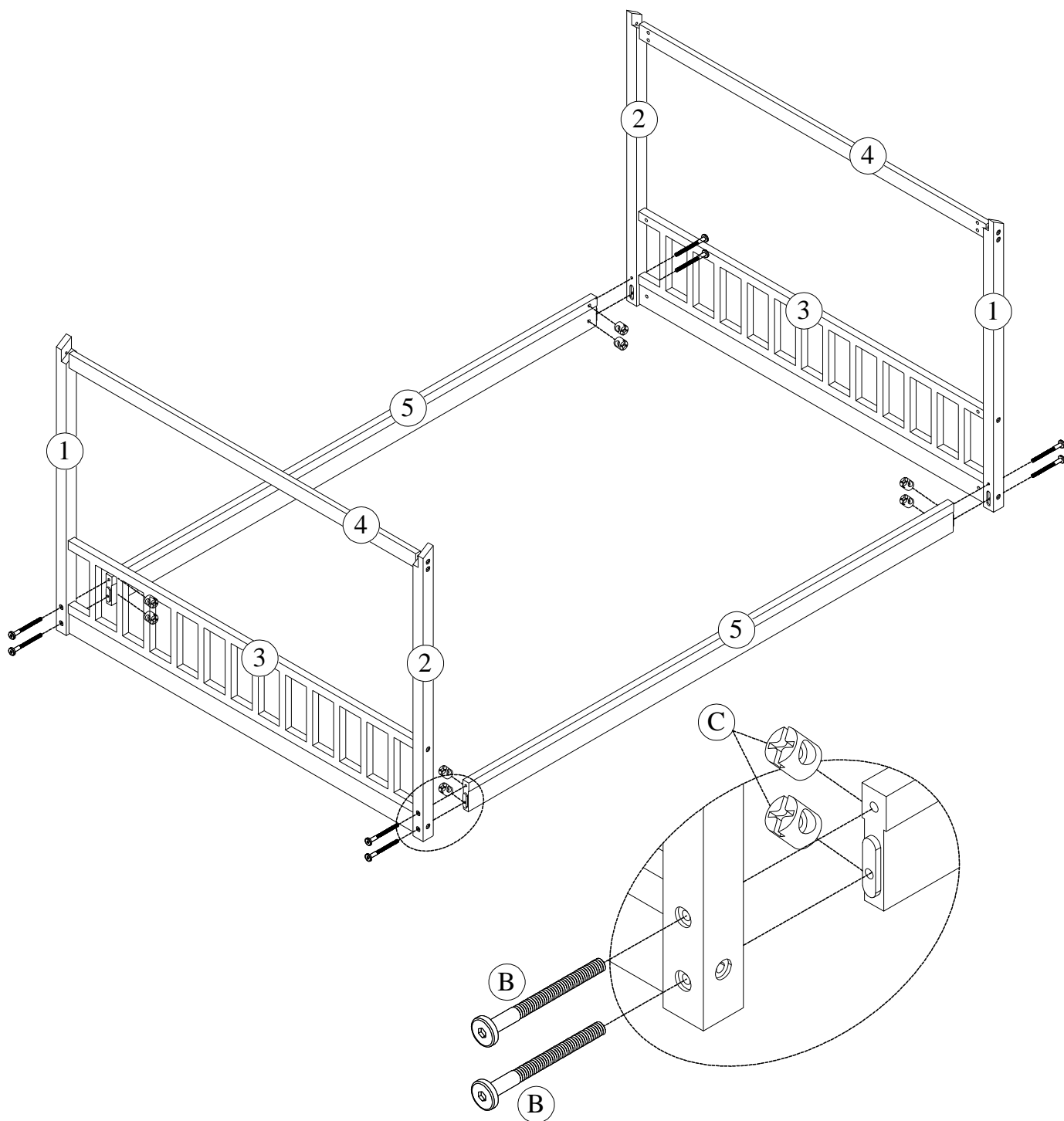

STEP2:  
ÉTAPE 2:

<b>B</b> 	<b>C</b> 
8PCS	8PCS



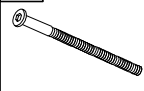

STEP 3:  
ÉTAPE 3:

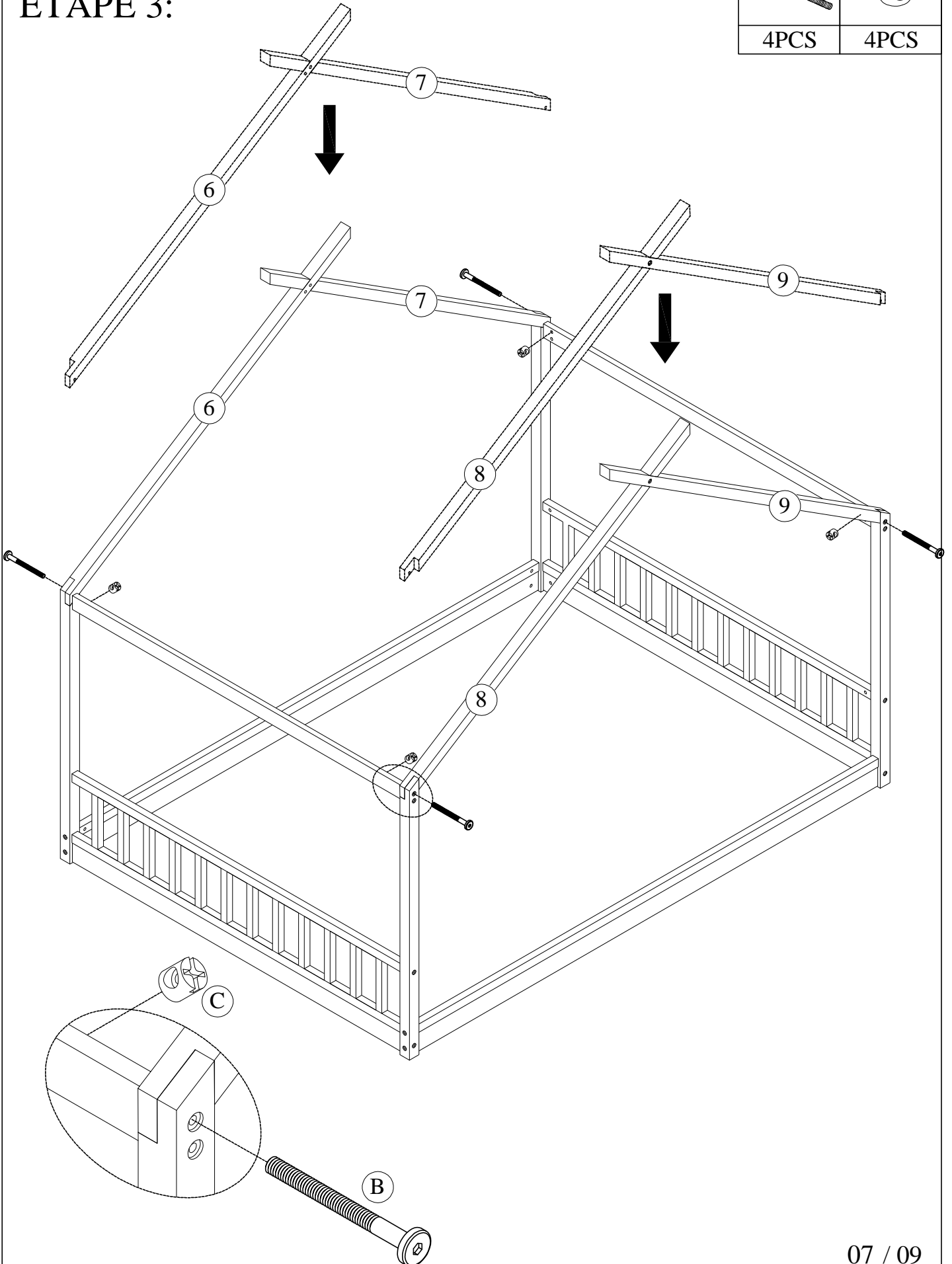
<b>B</b> 	<b>C</b> 
4PCS	4PCS

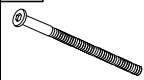

STEP 4:  
ÉTAPE 4:

A 	B 	C 
2PCS	2PCS	2PCS

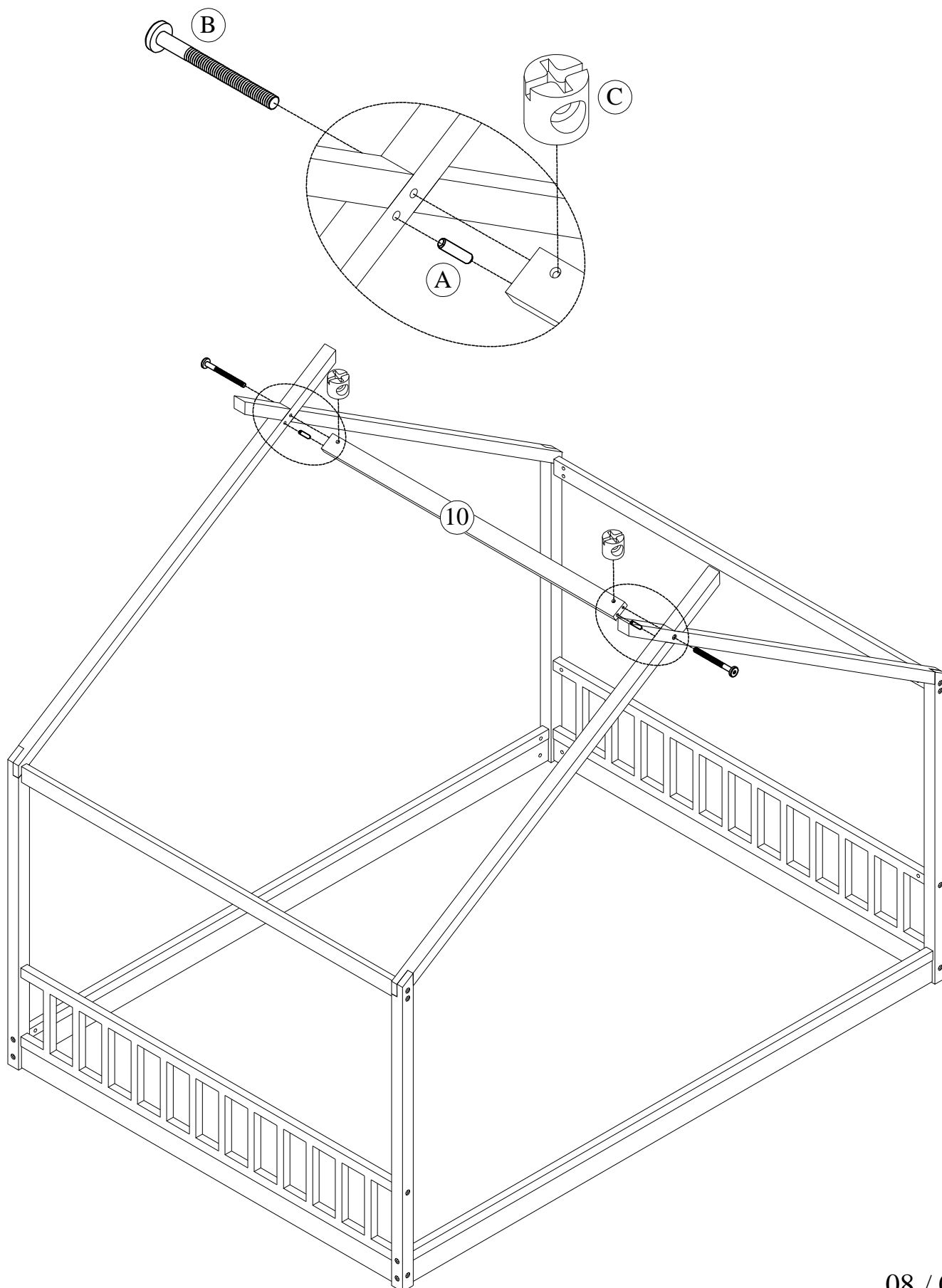

# COMPLETED COMPLÉTÉ

