

■ Dining Chair

ASSEMBLY INSTRUCTION



SKU:801

Dear customer, Thank you very much for buying our items. Please read the assembly instruction carefully before assembly.

Notices:

- Verify that all parts are present and in good condition before assembly.
- Put the chair on a clean flat surface.
- Please tighten the screws to about 80% for the first step; Then, sit with caution on the chair to adjust the balance; Finally, tighten all the screws to 100%.
- If you find that is unlevel after assembly, you can use adjustable pegs to keep four legs level.

Contact us

If there are installation problems, damage, missing parts, or any questions and concerns, please contact the shop where you bought it so we can make things right.

If the product is damaged, please send the following information:

- Photos that show the reason for your claim/damage.
- Photos of the packaging (inside and outside).

Thank you very much for your support!

Package Contents

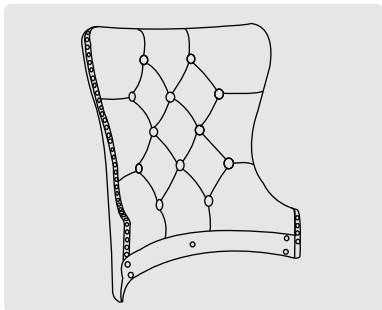

Back

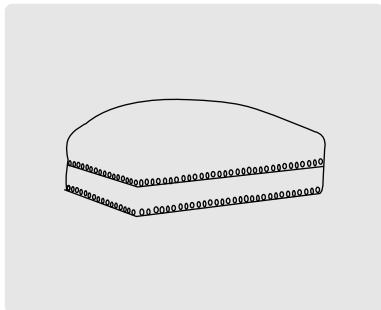

Seat

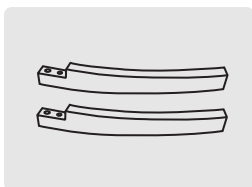

Back Legs

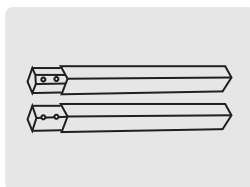

Front Legs

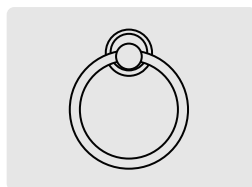

Pull Ring

A × 13

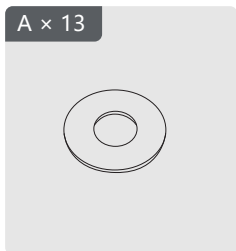

Washer

B × 13

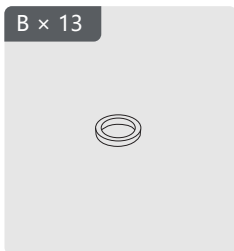

Spring Washer

C × 1

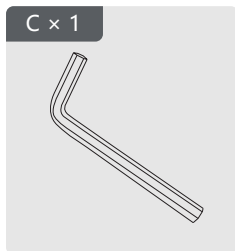

Spanner

D × 8

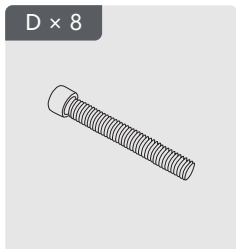

M8x55mm
Screws

E × 5

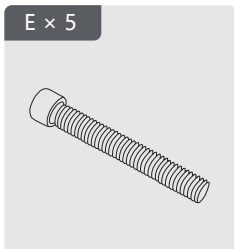

M8x60mm
Screws

Step by Step Guide

1

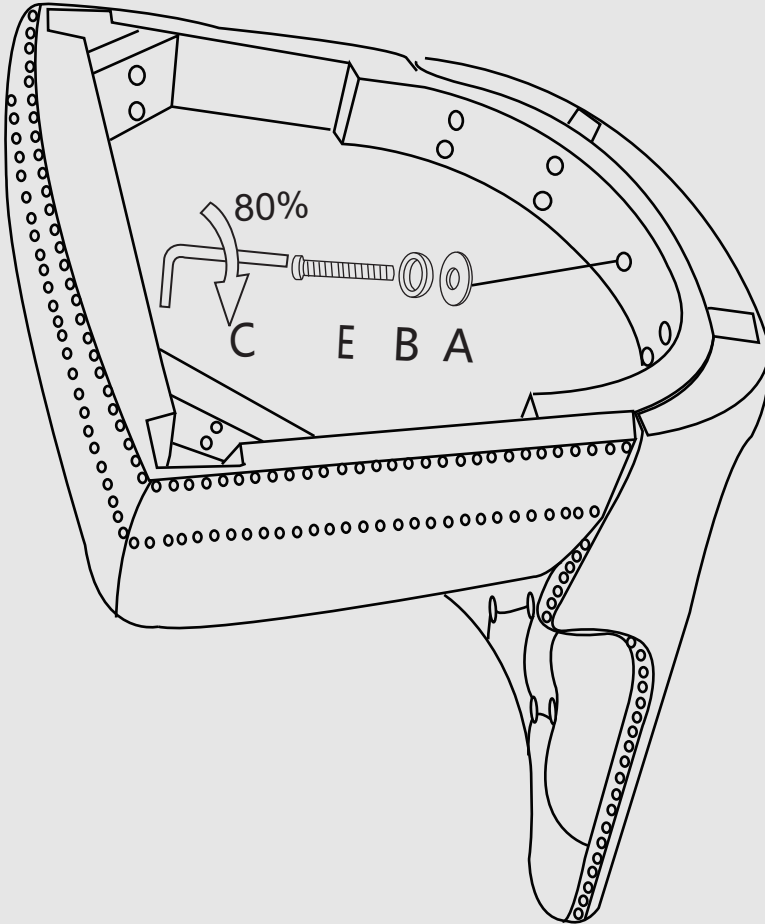

Align the center holes of the seat by using the screw (E) with washers (#A, B).
Just tighten them up to 60-80%.

Step by Step Guide

2

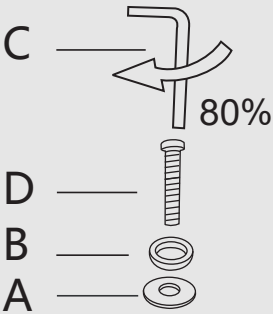
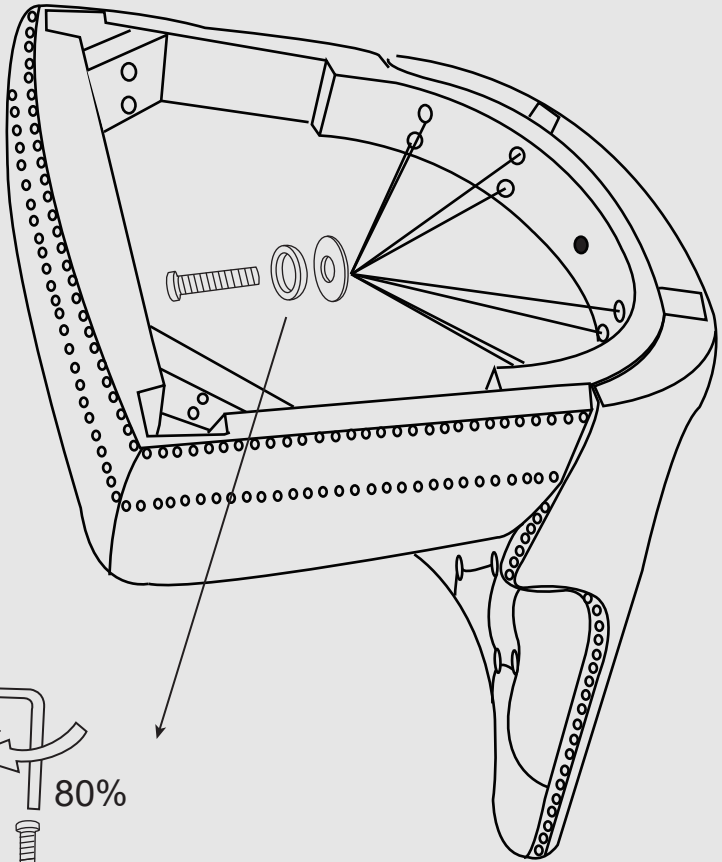

Align corner holes of the seat by using screws (D) with washers (#A, B).
Tighten all 4 screws at the same time up to 60-80%.

Step by Step Guide

3

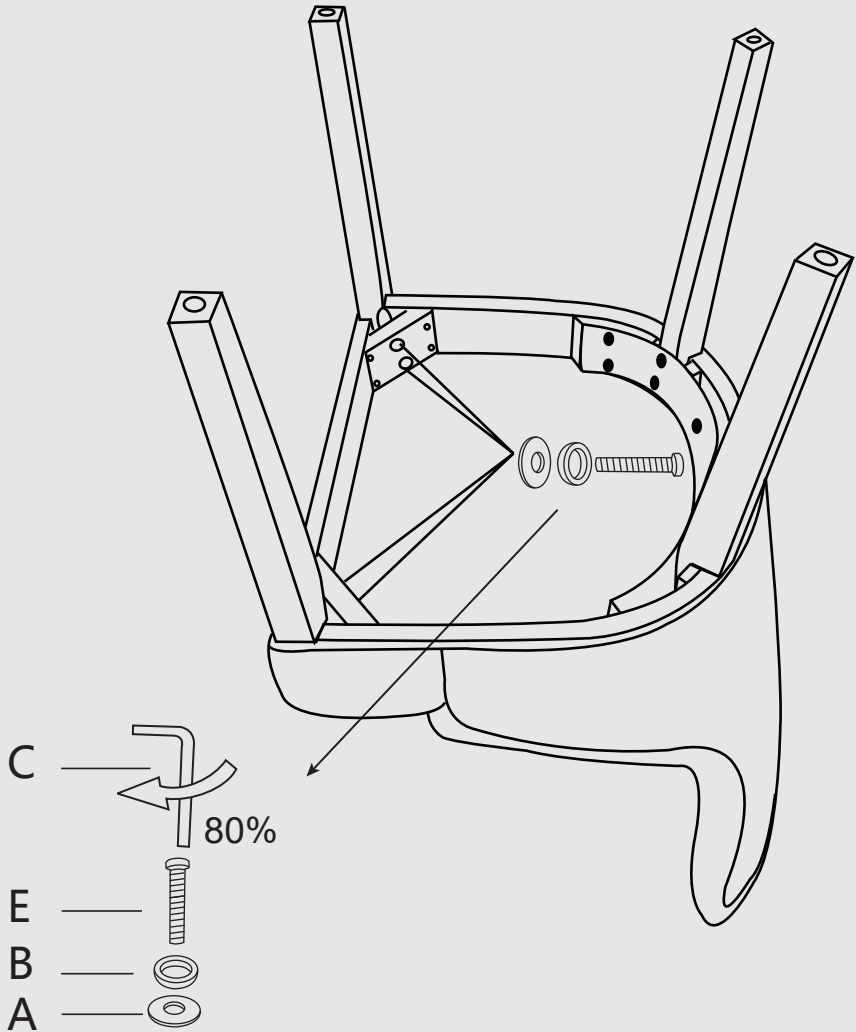

Align the front legs into the seat by using screws (E) with washers (#A, B).

Tighten All 4 screws together at the same time.
Just tighten them up to 60-80%.

Step by Step Guide

4

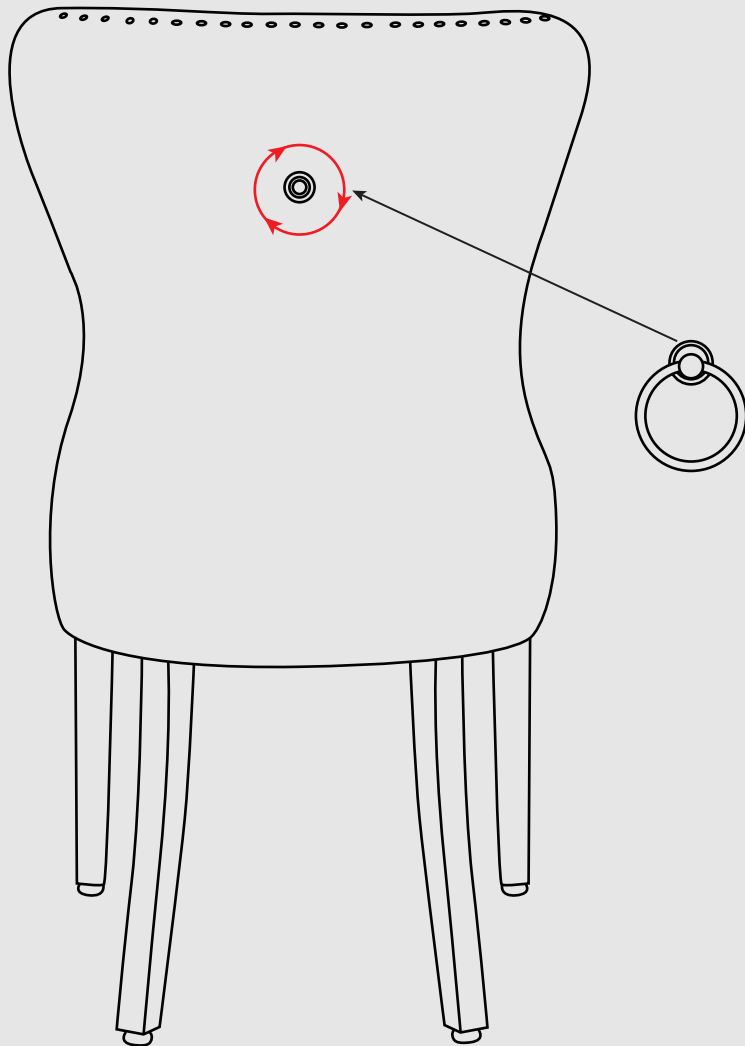

Align the pull ring with the screw on the back of the backrest
Tighten it up to 100%

Step by Step Guide

5

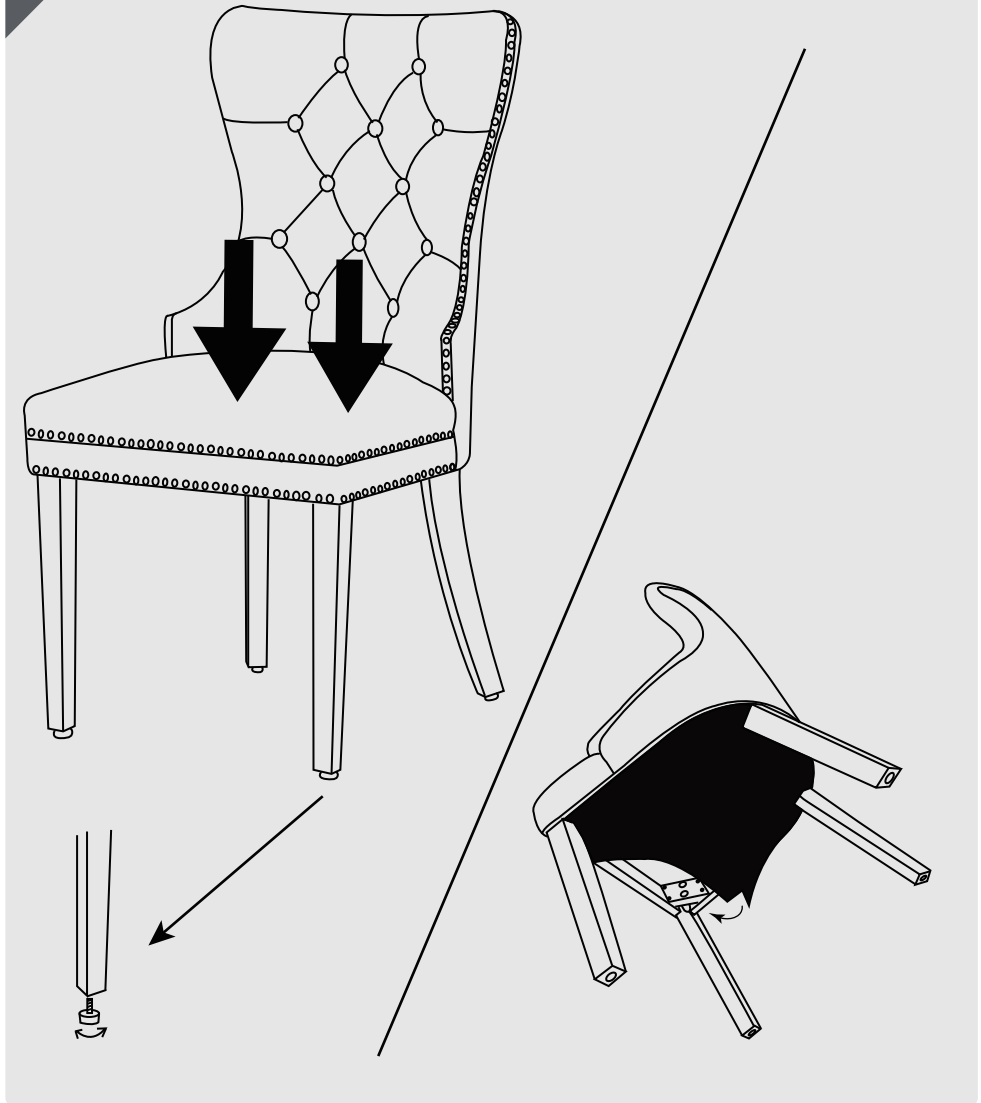

Please put a heavy object or one adult sit on and pressure the chair legs for leveling.
Once All legs are leveled, tighten all screws 100%.

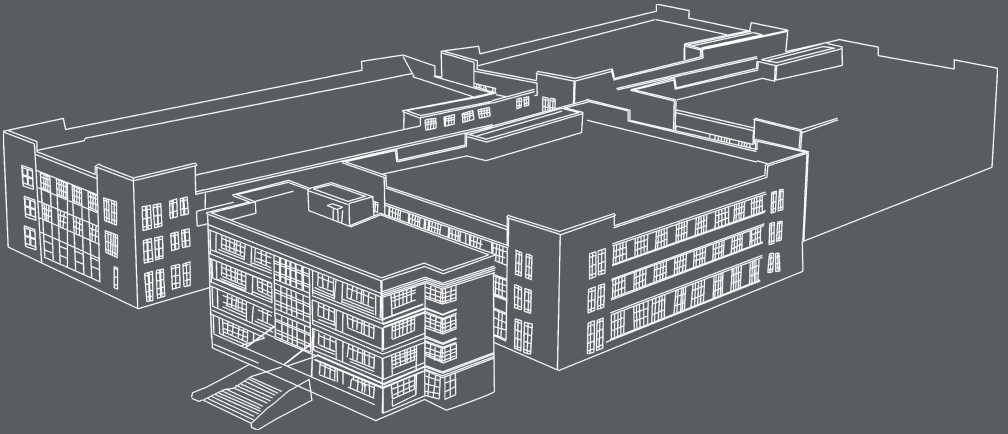

About us

We are a professional manufactory for making and selling dining chairs. In the past 15 years, we have exported millions of chairs to Europe and USA.

We focus on providing you with high-quality products that meet international standards. To ensure timely shipping, we have built large warehouses in California, New York, and Georgia.

Contact us

The fastest way to get more information about the deals!

Email: support@pekkohome.com