

## Wooden Storage Headboard with LED & Charging Station

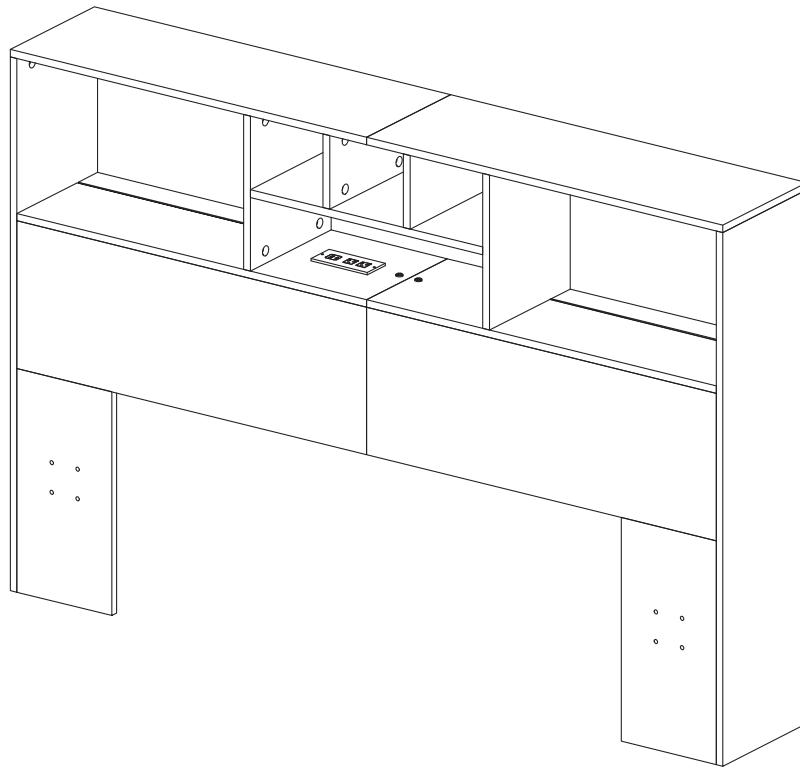

# NOTICE

---

**Please keep these instructions for future reference.**

**Dear Customer**

● Thank you for your purchase. When you receive the product, please make sure that all the parts are intact. If any parts are missing, please contact us promptly to request replacement parts.

● Then follow the entire installation instructions to install.

● Each part is crucial, so please be careful not to lose any. It is recommended to store parts with different lettered identifiers in separate boxes or bags to avoid confusion during installation.

**A .** The outer box is damaged

**B .** The product is damaged / bent / cracked while you open the box

**C .** The parts / accessories / assembly tools are missing

**D .** The instructions are not clear and can not be referred

**E .** The product has functional problems

**F .** Other aspects that you are not satisfied with

**Please feel free to contact us for help, and provide the following information:**

**Platform/Shop name/Order ID/buyer's name/ receiver's address/Problem description.**

# PART LIST

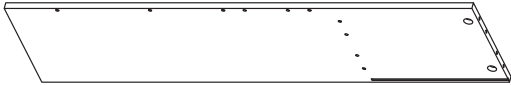
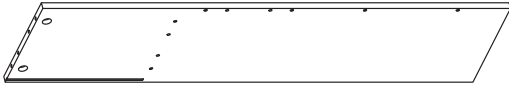
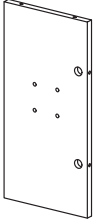
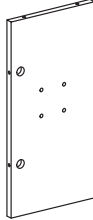
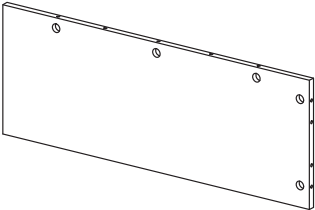
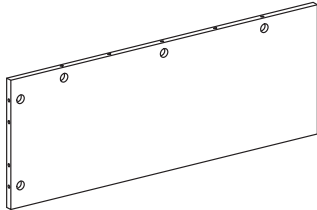
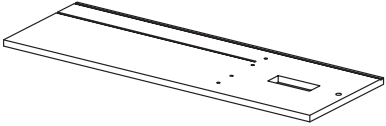
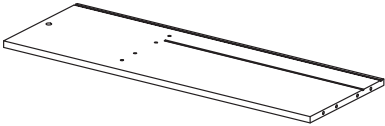
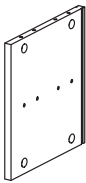
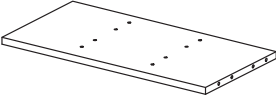
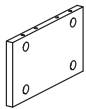
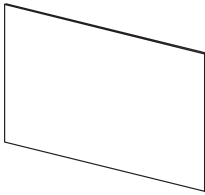
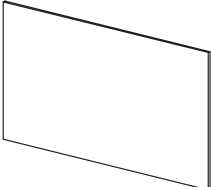
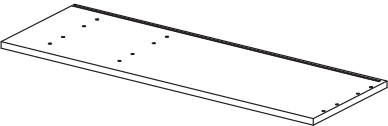
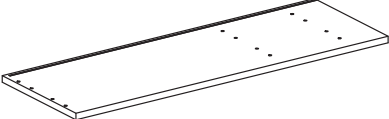
<b>1</b>  x1PC	<b>2</b>  x1PC
<b>3</b>  x1PC	<b>4</b>  x1PC
<b>5</b>  x1PC	<b>6</b>  x1PC
<b>7</b>  x1PC	<b>8</b>  x1PC
<b>9</b>  x2PCS	<b>10</b>  x1PC
<b>11</b>  x2PCS	<b>12</b>  x2PCS
<b>13</b>  x1PC	<b>14</b>  x1PC
<b>15</b>  x1PC	

# PART LIST

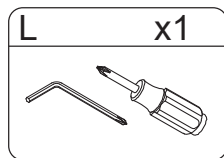
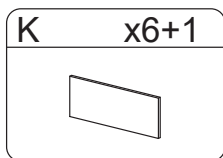
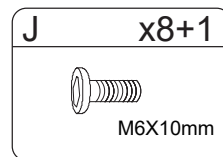
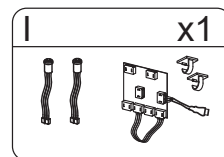
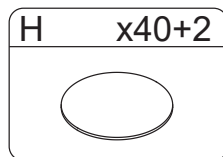
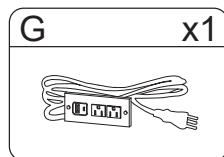
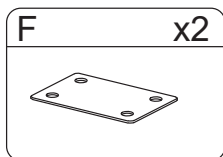
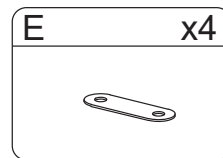
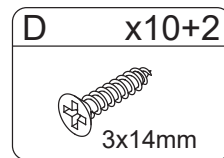
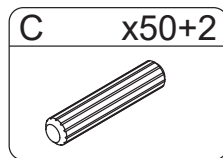
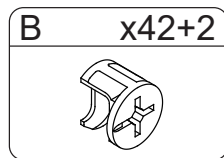
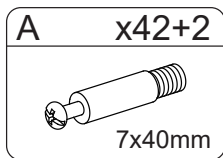
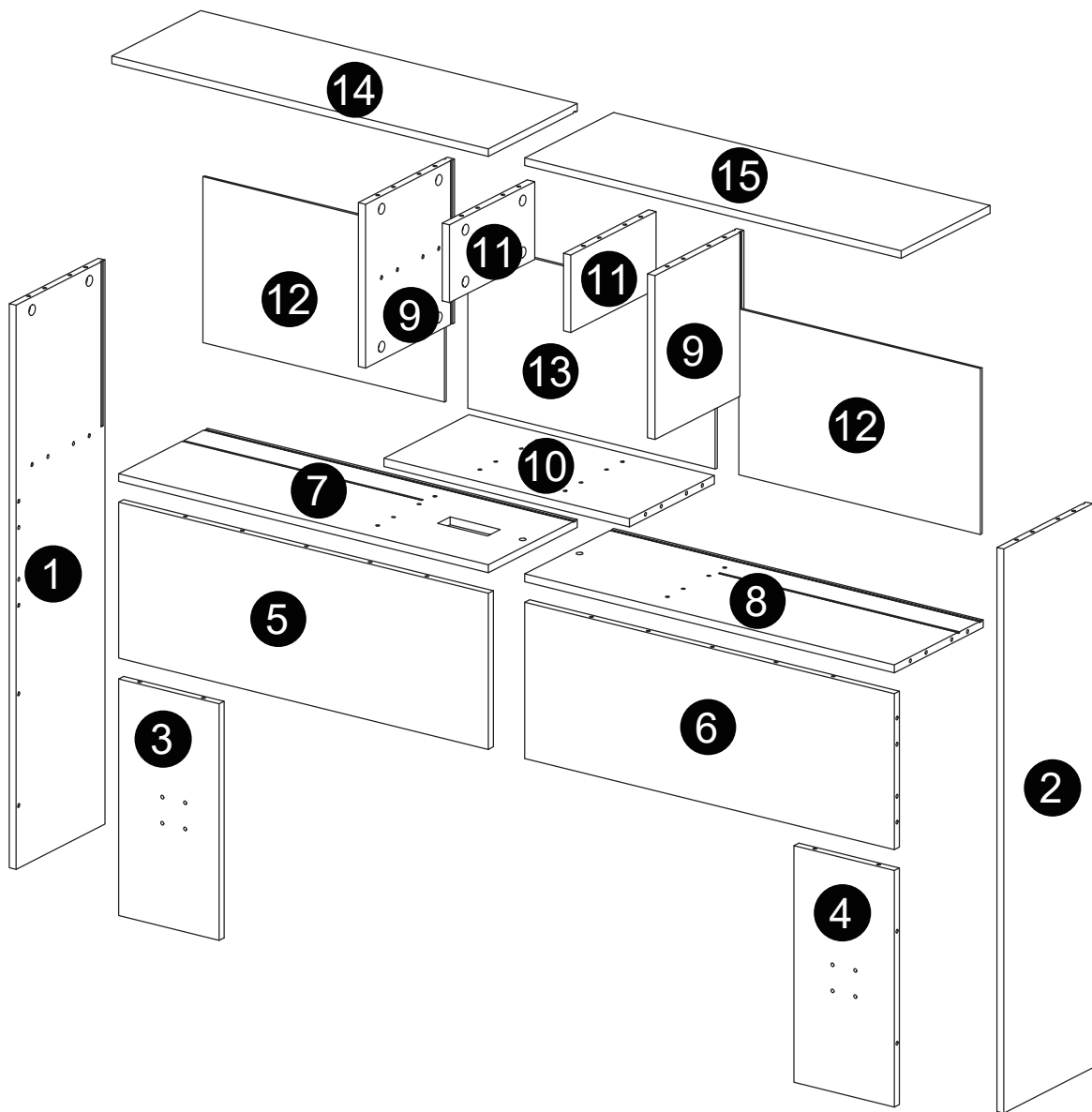

# STEP

01

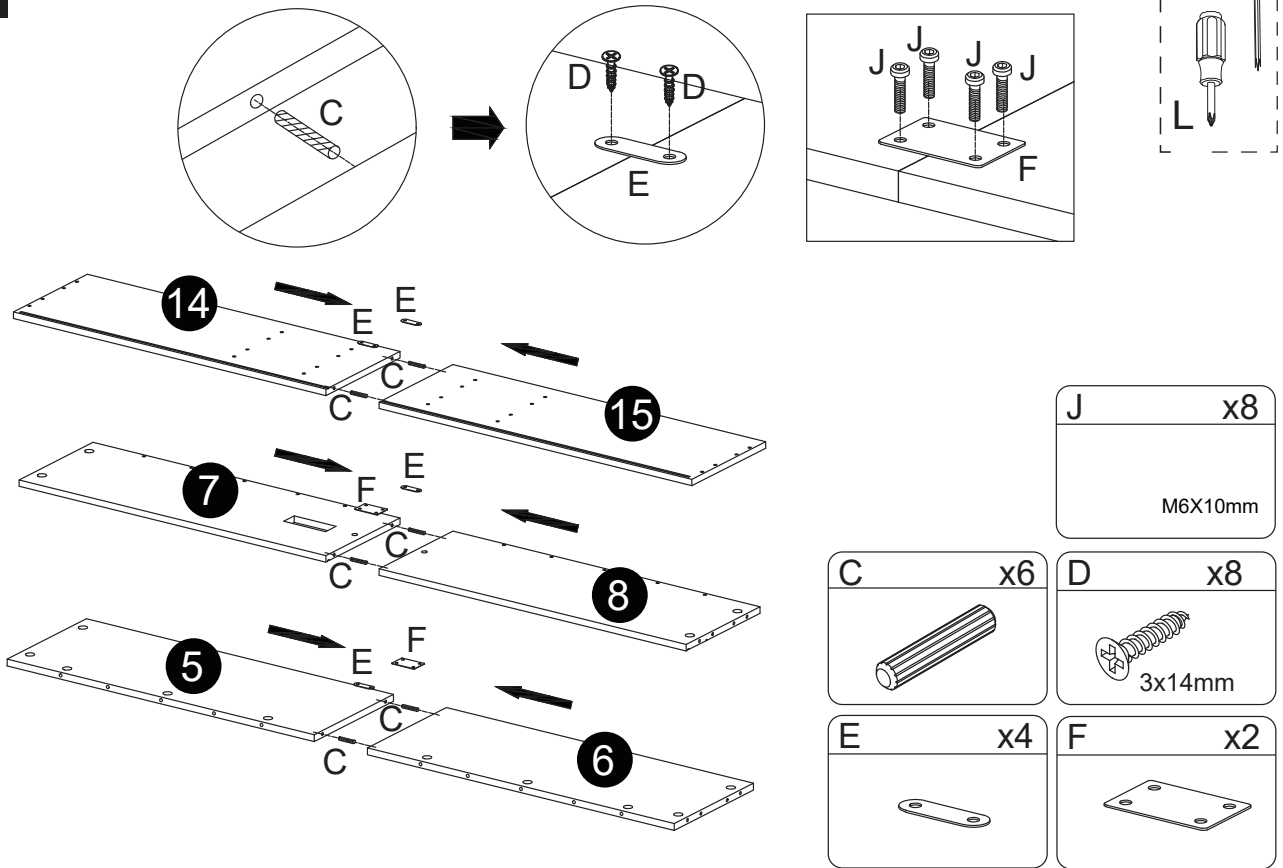

02

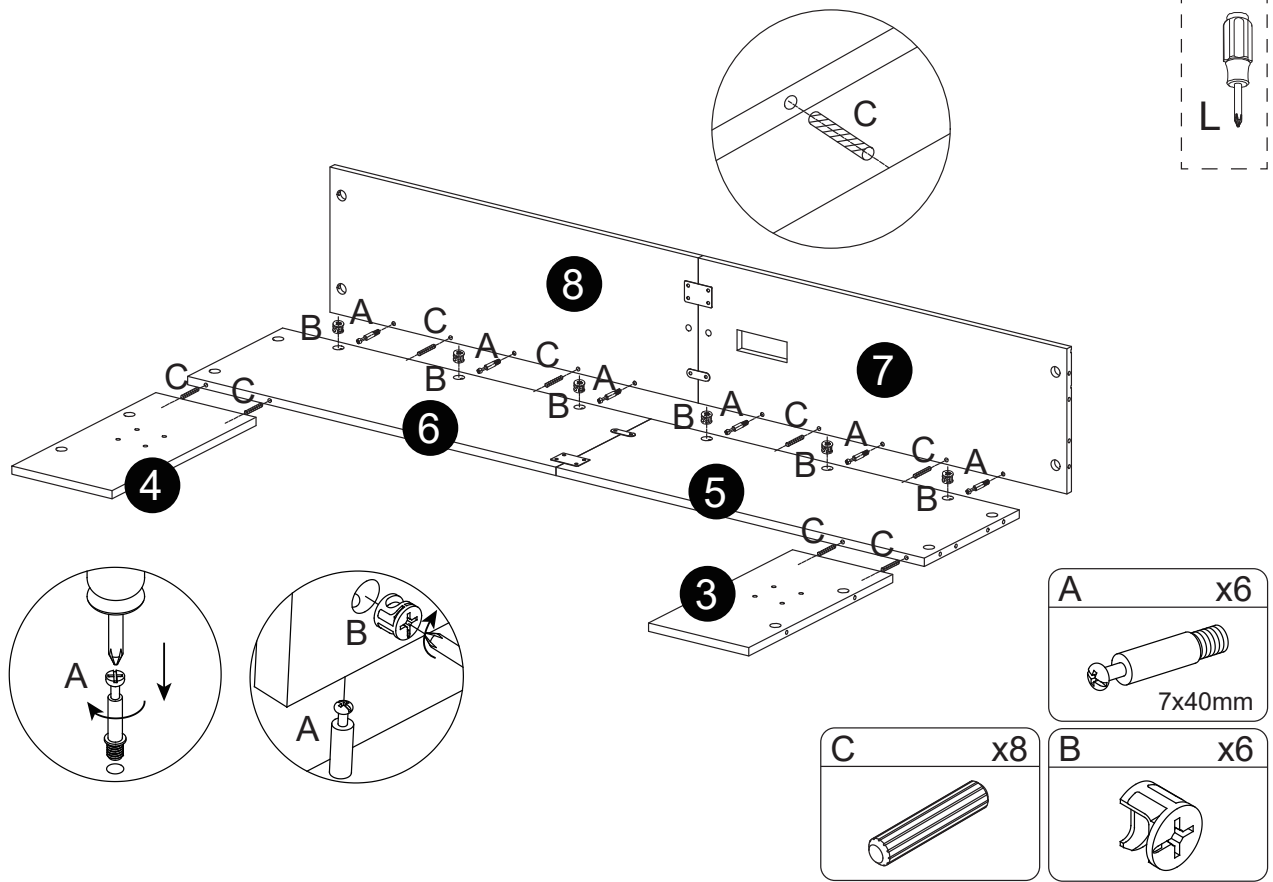

# STEP

03

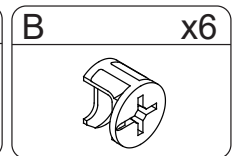
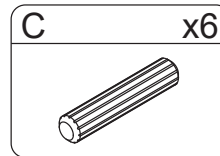
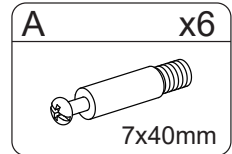
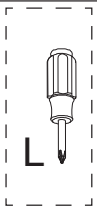
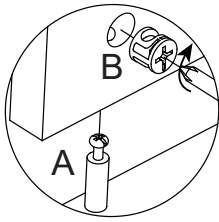
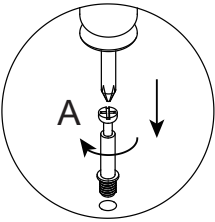
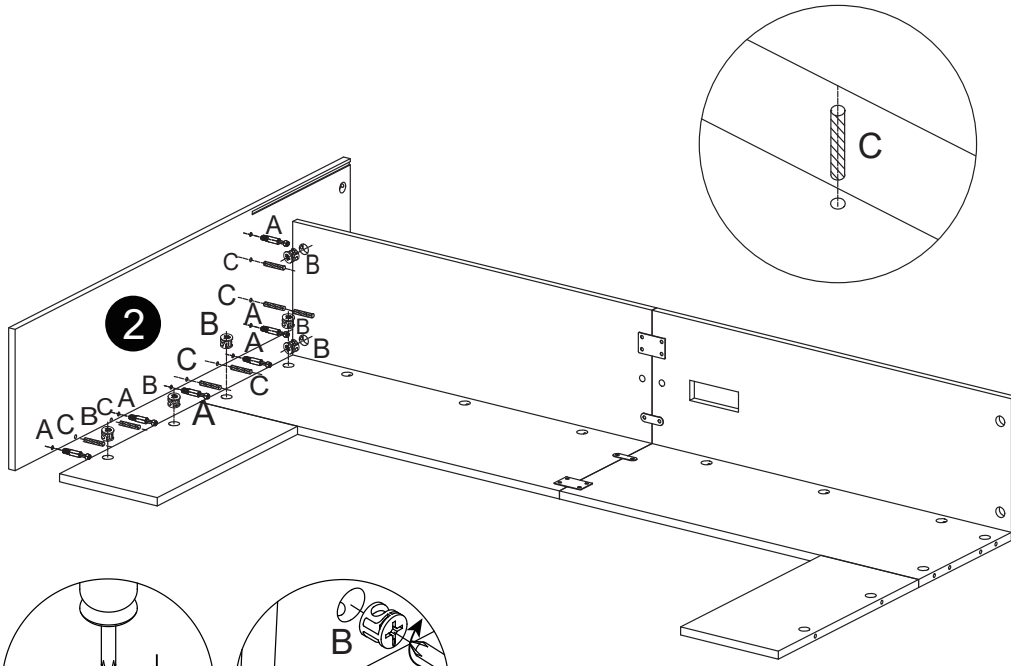

04

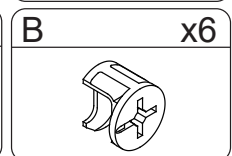
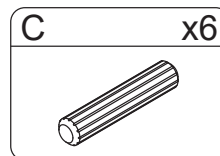
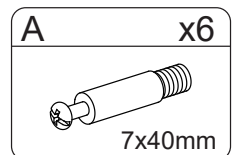
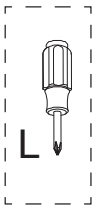
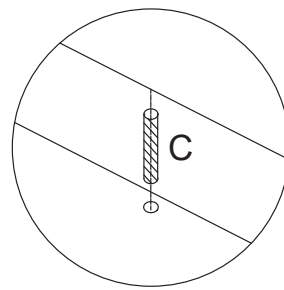
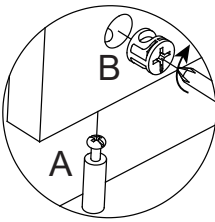
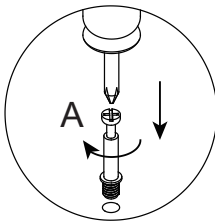
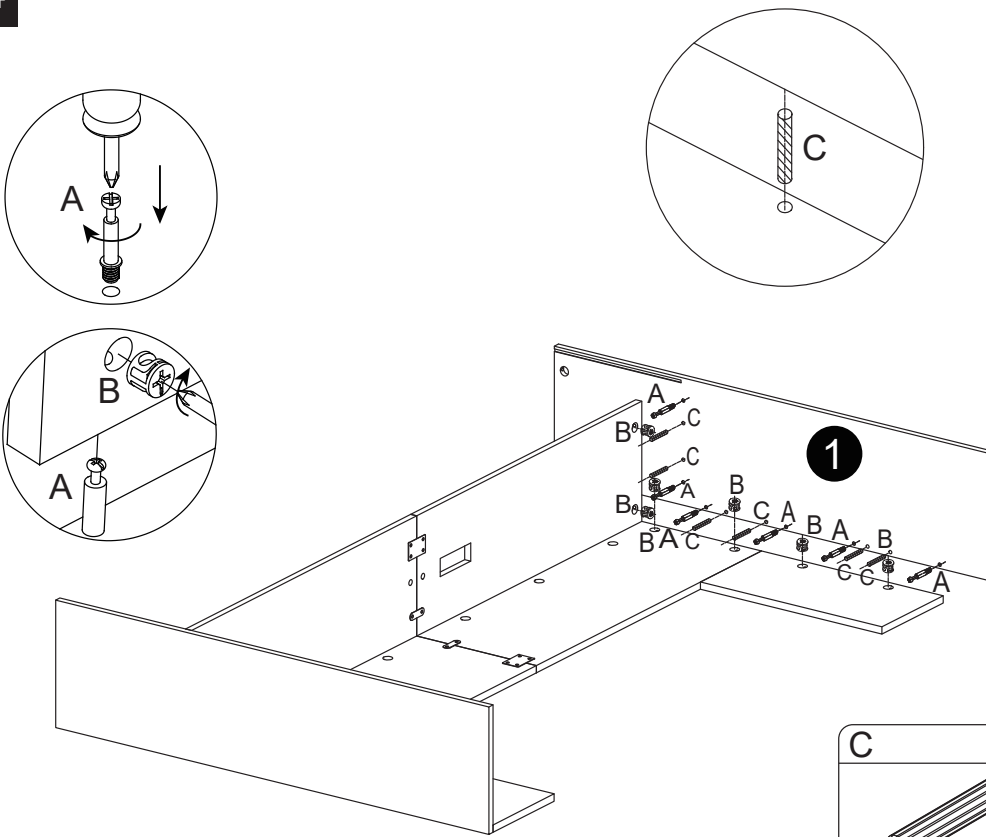

# STEP

05

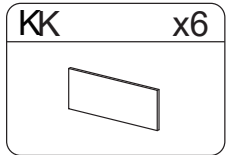
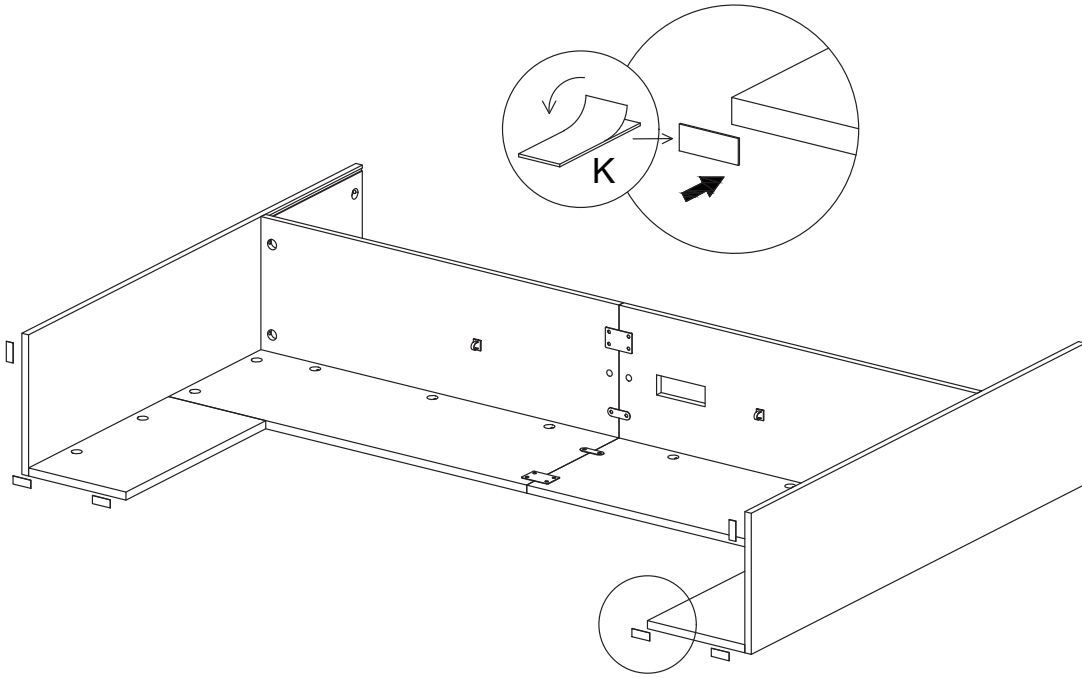

06

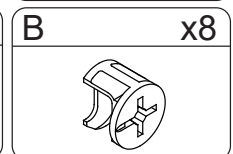
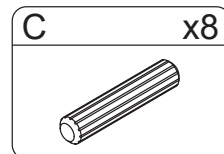
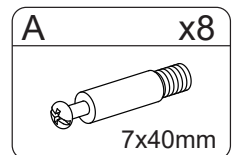
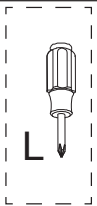
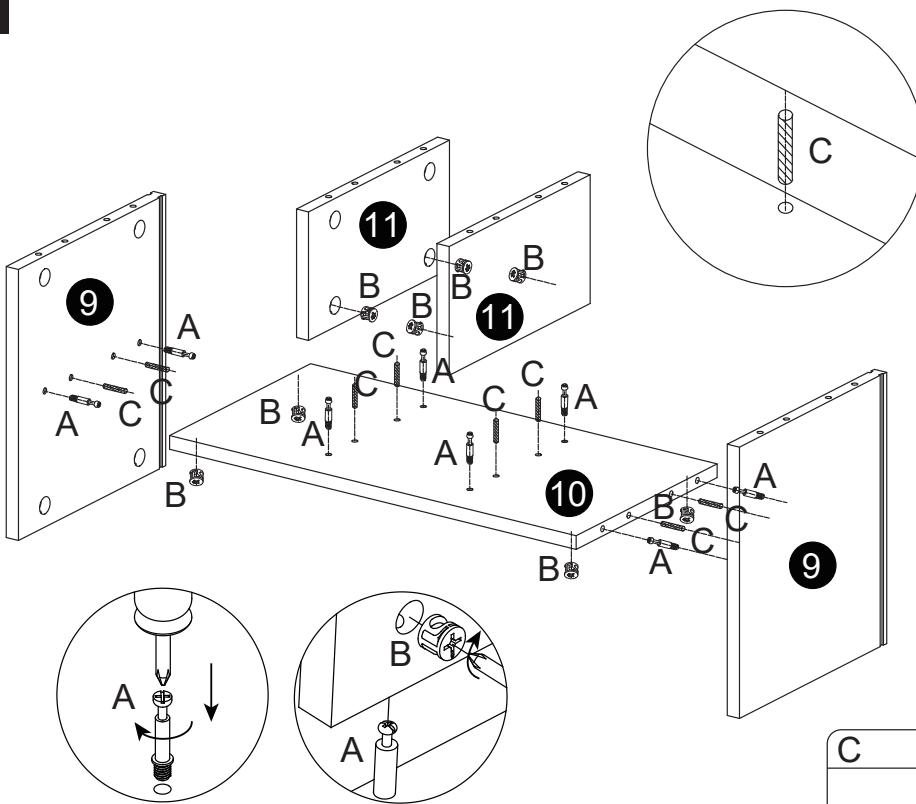

# STEP

07

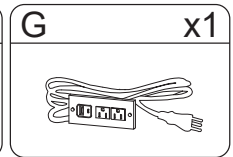
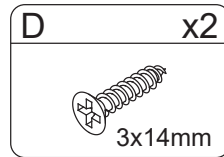
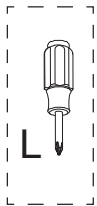
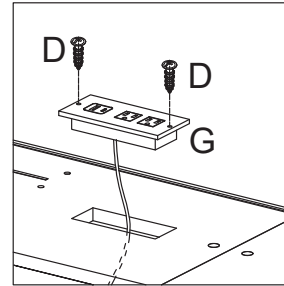
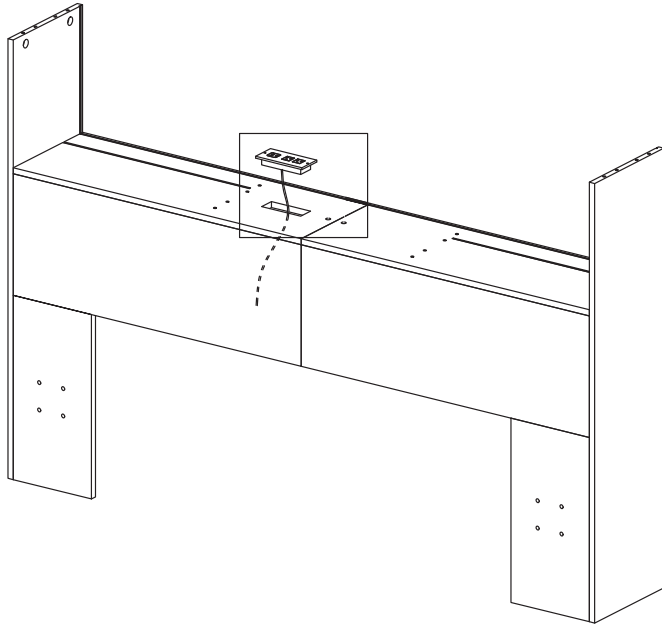

08

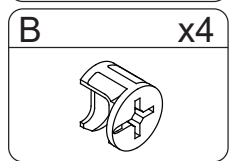
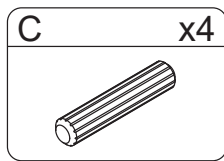
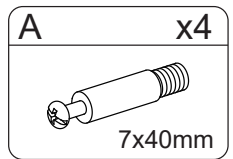
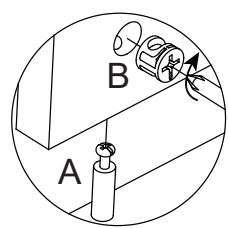
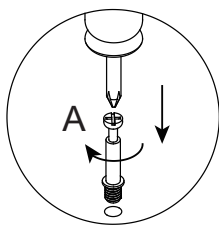
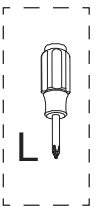
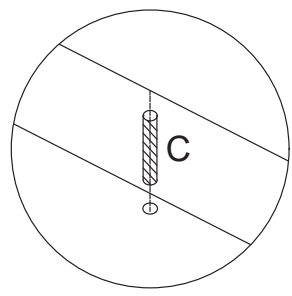
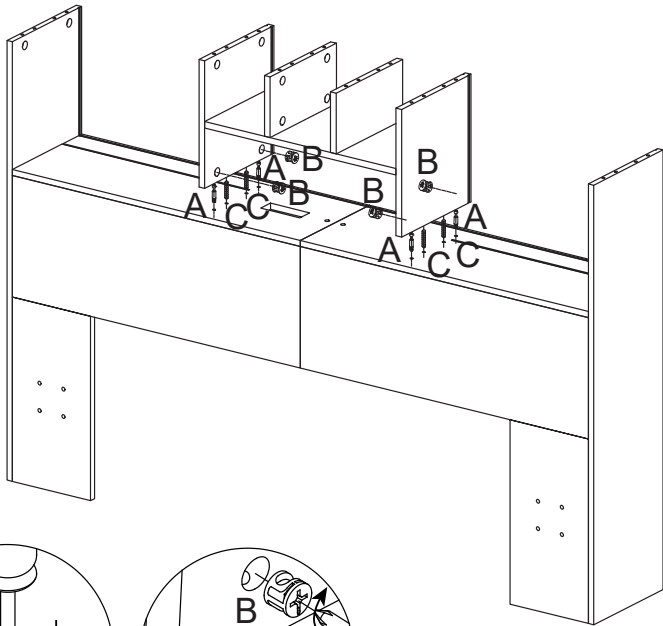

# STEP

09

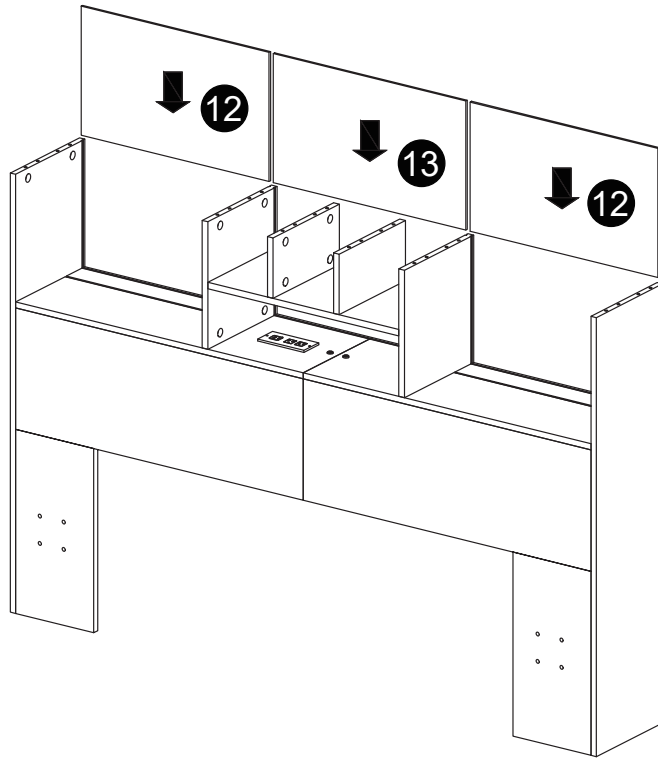

10

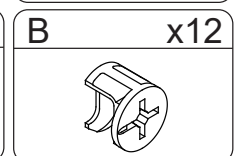
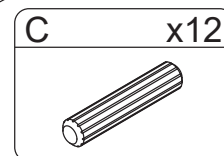
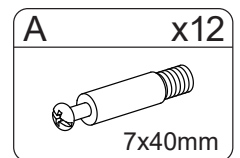
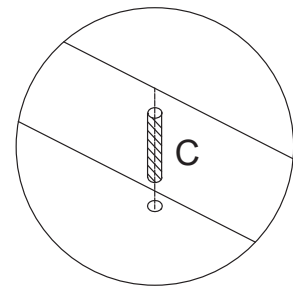
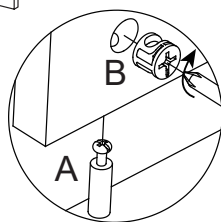
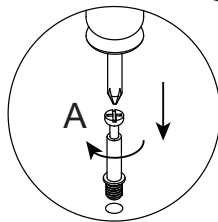
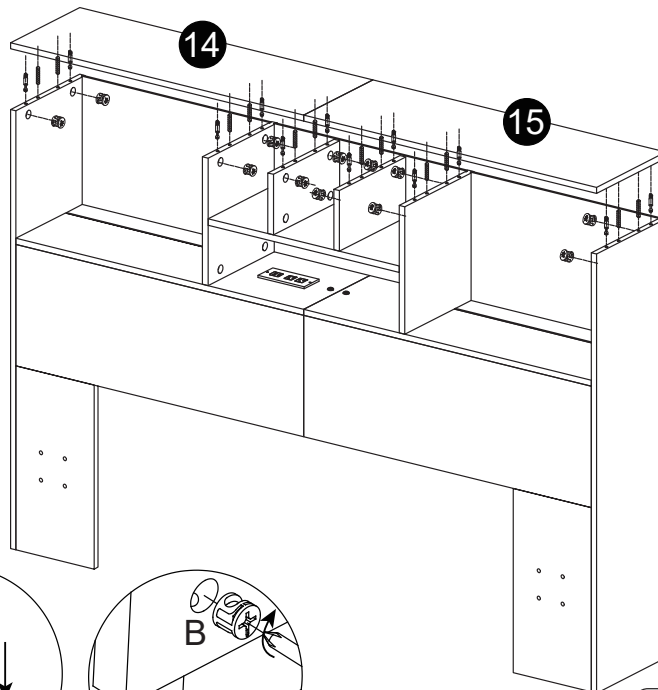

08

11

Two lines with identical functions must be plugged into the same side.

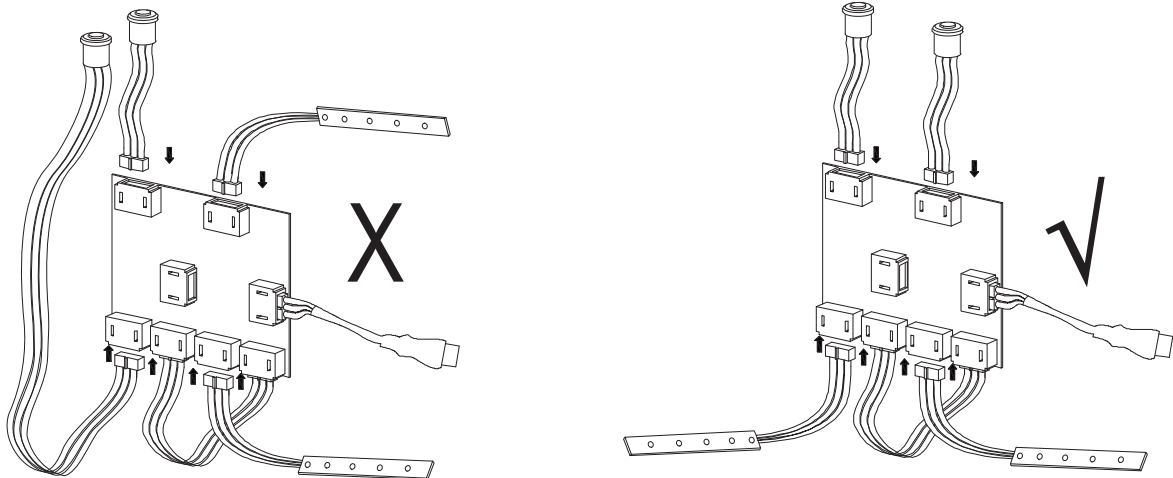

Connect the controller

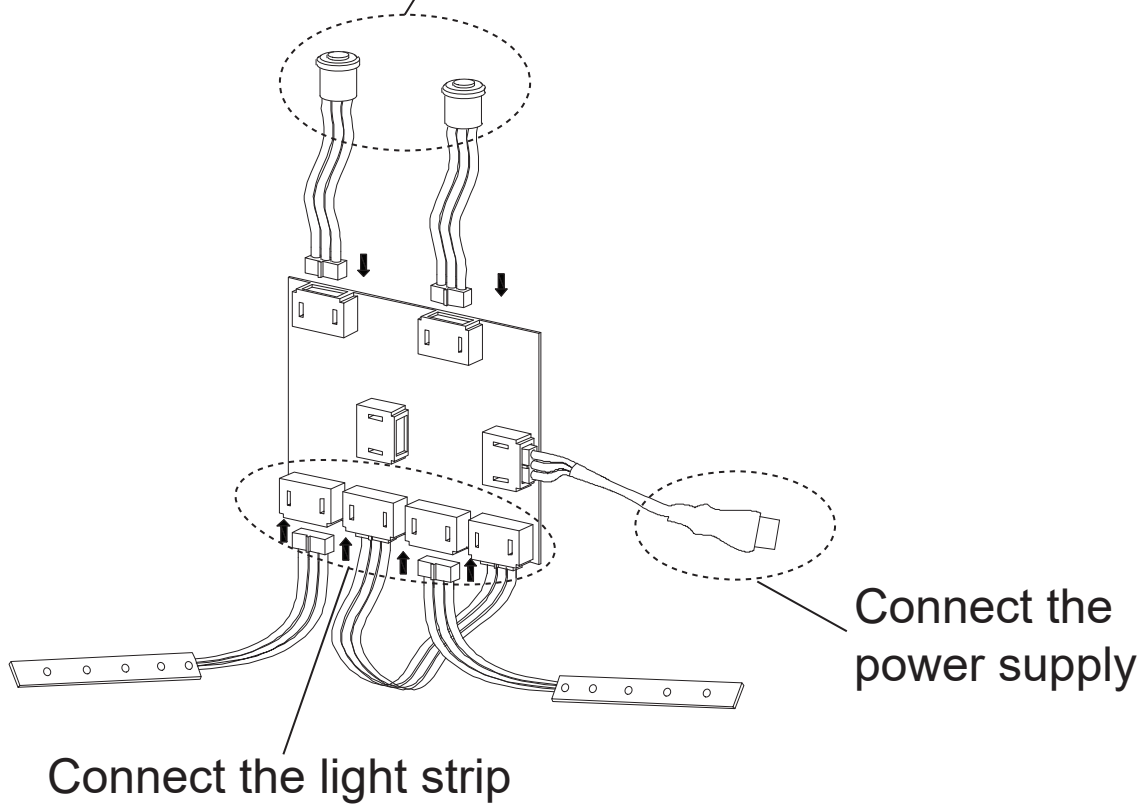

# STEP

12

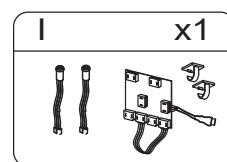
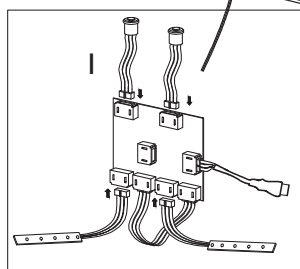
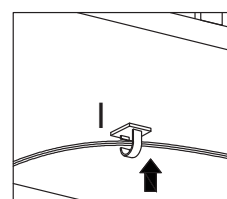
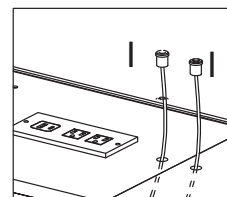
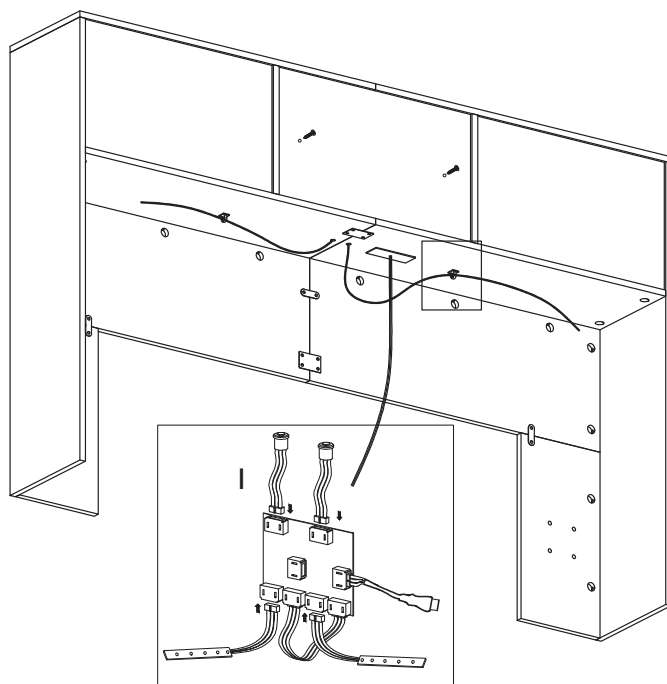

13

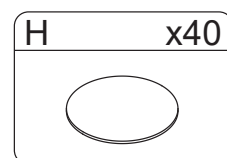
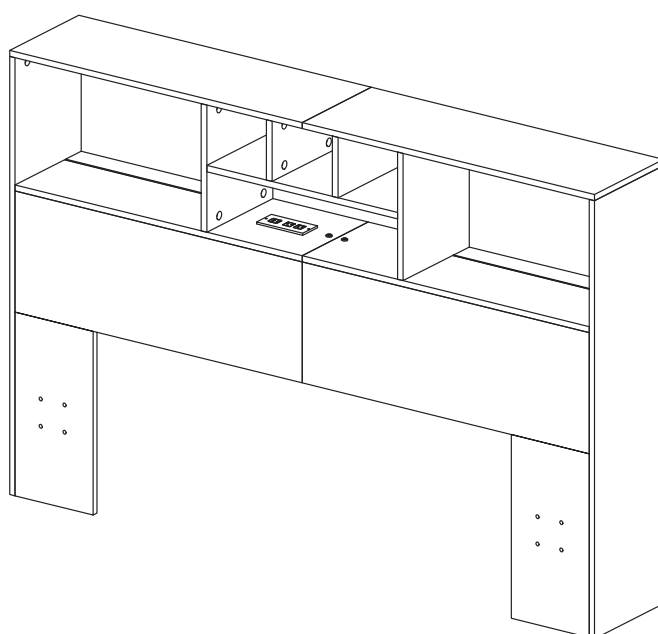
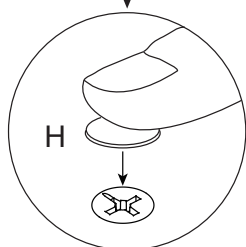
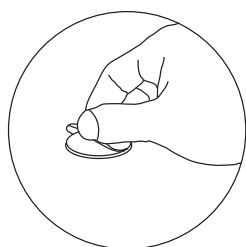

# **AFTER-SALE SERVICE**

If you have any suggestions for our products or notice any quality issues, please contact us first. Our after-sales team will respond within 24 hours and will do everything possible to provide you with a satisfactory solution.