

## CARE AND MAINTENANCE







Wipe clean with a soft, dry cloth. Test the cleaning method on a hidden area before using them over the entire area.

## NOTICE

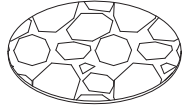
- \* Please make sure that you have all parts indicated before you begin assembly of this item.
- \* This item should be assembled on a soft surface to prevent scratching the finished product during assembly.
- \* This item may require periodic tightening.
- \* Do not tighten bolts until completely assembled.

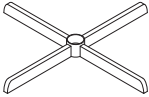
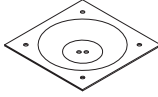
Product Dimensions:  $\phi$ 19-5/8"Dx17-3/4"H

## Part List and Hardware List

PIECE	DESCRIPTION	PICTURE	QUANTITY
A	Table top		1x
B	Table post		1x
C	Bottom base		1x
D	Mount plate		1x
H1	Allen bolt	 1/4"x5/8"	8x
H2	Flat washer	 $\phi$ 13*1.0	6x
H3	Allen key	 M4	1x

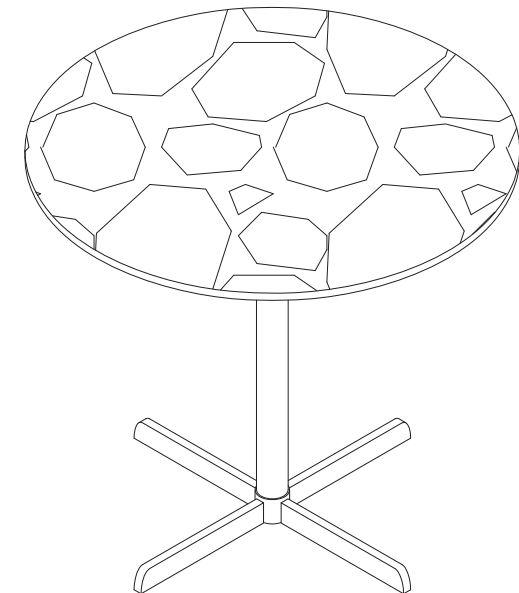

Weight capacity:25lbs  
 WARNING:DO NOT STAND ON TABLE  
 WARNING:DO NOT OVER TORQUE BOLTS

## PREPARATION

Before beginning assembly of product, make sure all parts are present. Compare parts with package contents list and hardware contents list. If any part is missing or damaged, do not attempt to assemble the product.

Estimated Assembly Time: 15 minutes.

Tools Required for Assembly (included): Allen Key

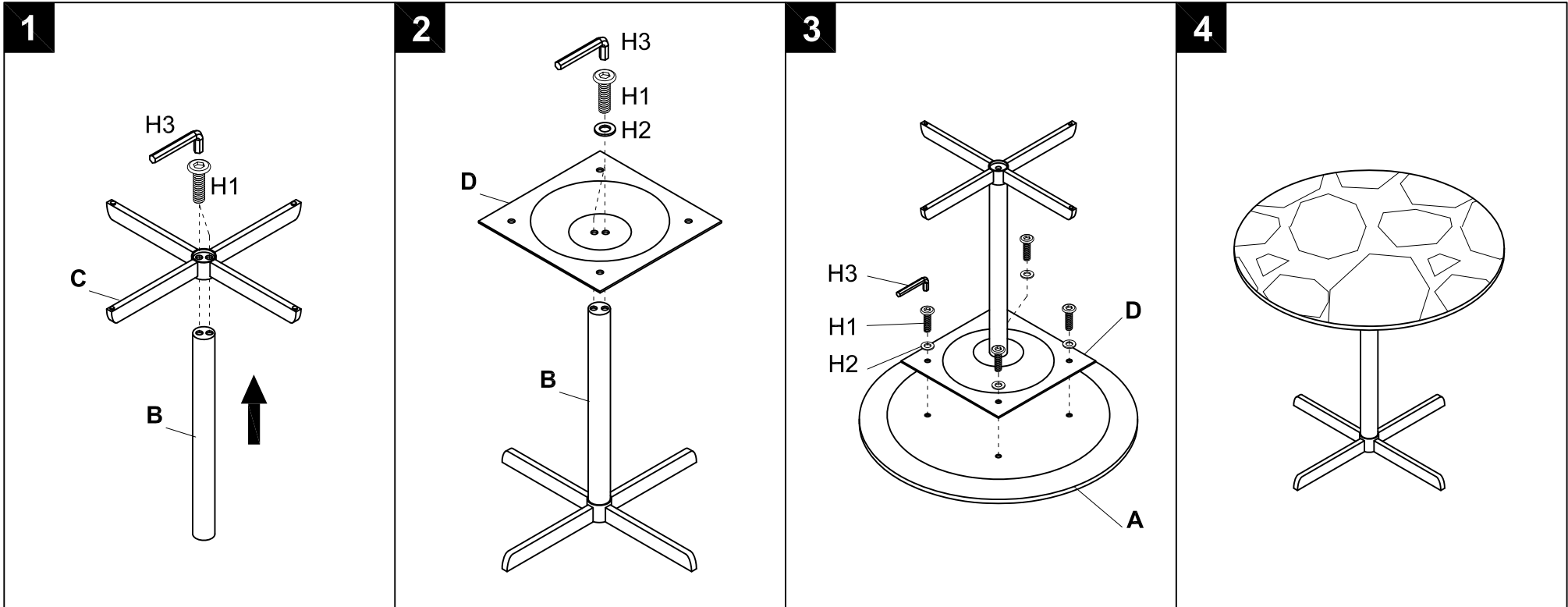

### Step 1

Attach table post (B) to the bottom base (C), Use Allen Key (H3) to lock with 2\*Allen bolts (H1).

### Step 2

Then attach the mount plate (D) to top of table post (B), Use Allen Key (H3) to lock 2\*flat washer (H2) with 2\*Allen bolts (H1), as picture.

### Step 3

Attach the assembled metal base to the underneath of table top (A), through the holes of mount plate and use Allen Key (H3) to lock 4\*flat washer (H2) with 4\*Allen bolts (H1), as picture.

### Step 4

Straighten up the assembled table, Assembly is completed.