

# Assembly Instructions

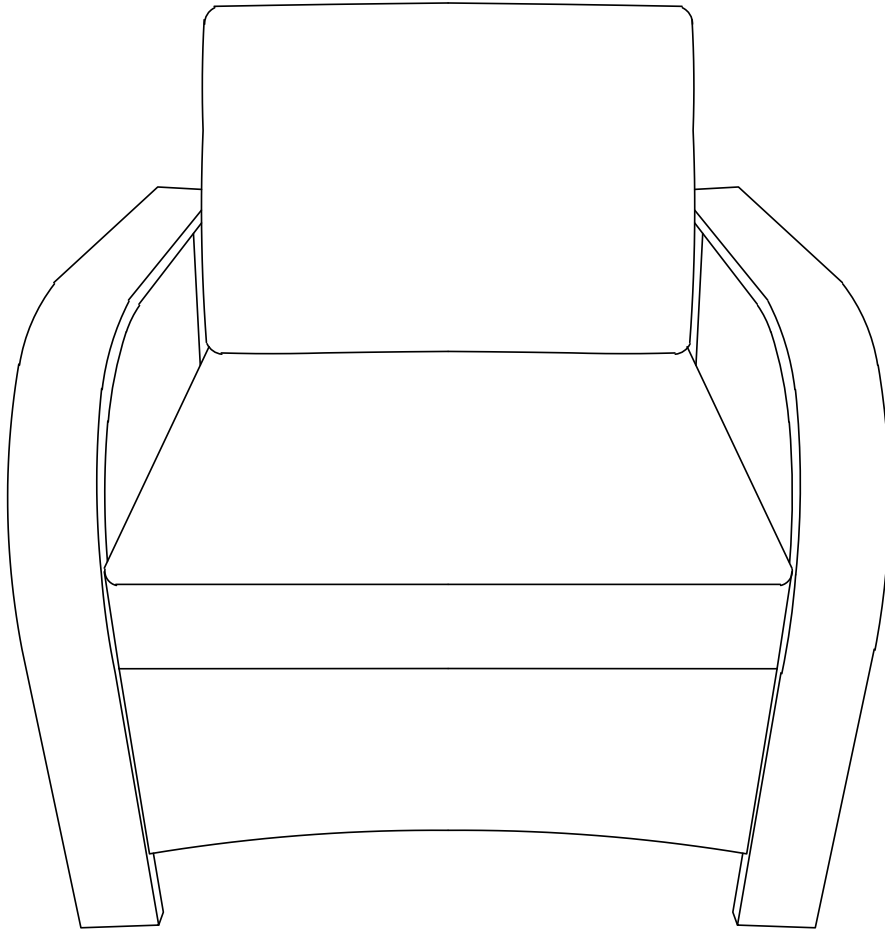







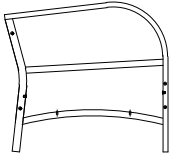

For any missing hardware, damaged parts and other problems.  
WELCOME to email us at: [service@behousewell.com](mailto:service@behousewell.com)

Or call at 1-888-733-8169 Toll free  
Between 9AM and 5PM Eastern time, Monday through Friday

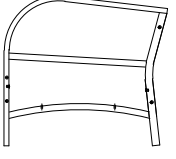
**\*Don't fully tighten all the bolts till the very end!**

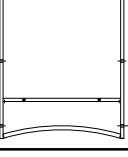
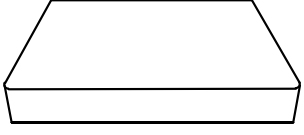
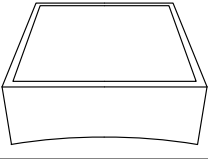

## PRE-ASSEMBLY PREPARATION:

- Please read through the instructions before beginning assembly.
- Clear out the space for assembly and lay out all of the parts based on the Parts List, extra room will allow you to easily determine if all the pieces are present.
- Keep small parts and pieces away from children until fully assembled.

Part no.	Part	QTY	Image	Part no.	Part	QTY	Image
A1	Left arm	1		F	Bolt M6*35mm	8	
A2	Right arm	1		G	Washer Ø16*Ø6.5*1	10	
B	Back	1		H	Seat cushion	1	
C	Seat	1		I	Back cushion	1	
D	Allen wrench	1					
E	Bolt M6*40mm	2					

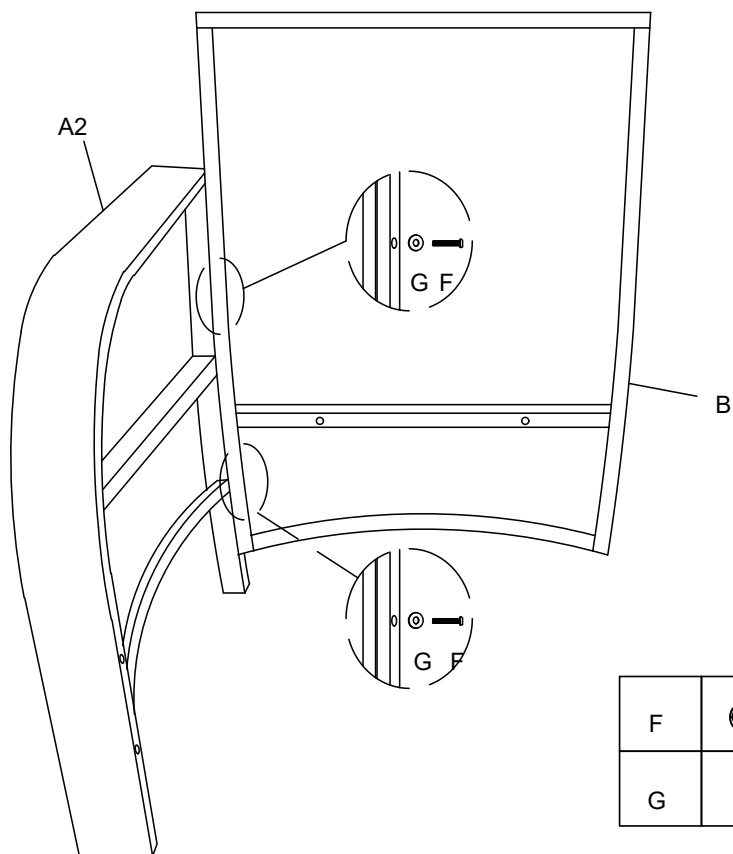

**Step 1:** Attach right arm A2 to back B with 2pcs bolts F and 2pcs washers G, using Allen wrench D. Note: Don't fully tighten the bolts.



F		M6*35	2
G		M6	2

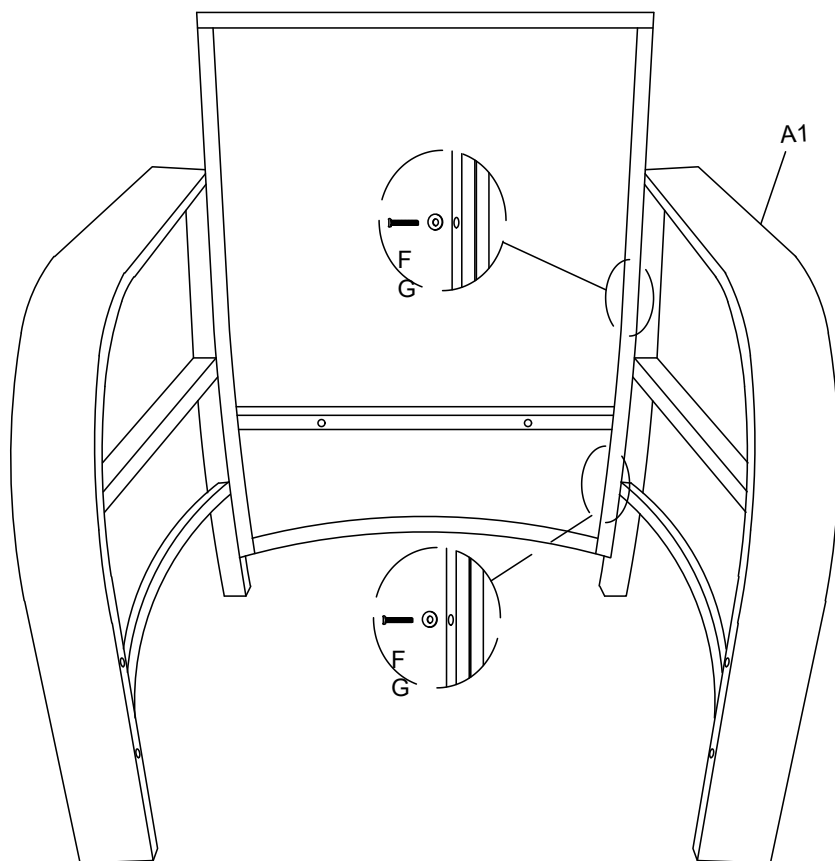

**Step 2:** Attach left arm A1 to back B with 2pcs bolts F and 2pcs washers G, using Allen wrench D. Note: Don't fully tighten the bolts.

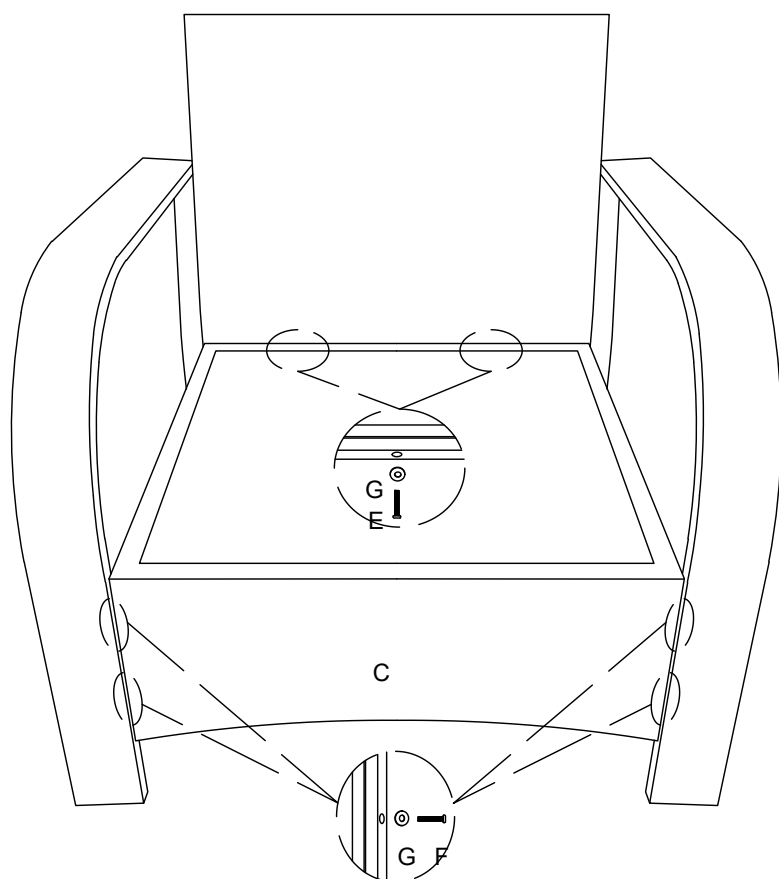

F		M6*35	2
G		M6	2

**Step 3:** Attach seat C to arms A1&A2 and back B with 2pcs bolts E ,4pcs bolts F and 6pcs washers G, using Allen wrench D. Note: Please fully tighten the bolts.



E		M6*40	2
F		M6*35	4
G		M6	6

**Step 4:** Put back cushion I and seat cushion H onto the seat .Assembly is now complete and the product is ready for use.

