

# Recliner Assembly Instructions

Your recliner comes packaged in one box.

**DO NOT** use any sharp objects to open plastic wrapped components as damage to product or components may result.

Carefully remove all of the components from the packaging and set aside for assembly. Assemble on a soft surface to prevent scratching the finish.

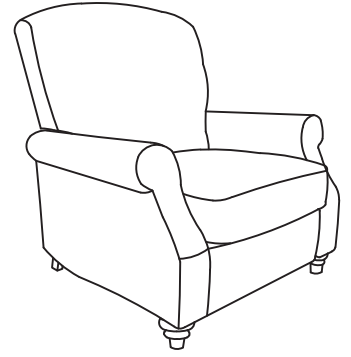

## Parts List

**A** 1 x Seat Back



**B** 1 x Seat

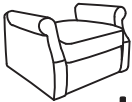

\* **C** 2 x Front Legs



\* **D** 2 x Back Legs



\* **E** 4 x Washers



\* Replaceable Parts

## Assembly

Step 1

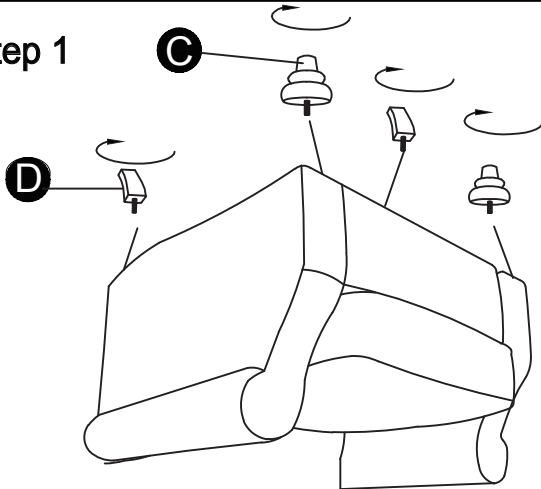

Step 2

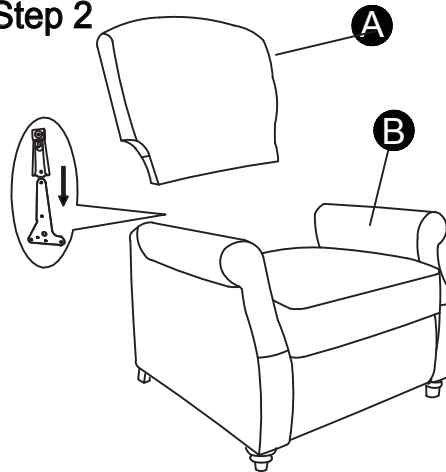

OPTIONAL

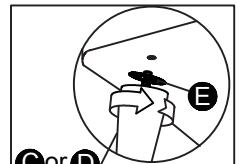

**C** or **D**

Adjust each leg by inserting a washer (E) to make it even and level with the floor.

Step 3

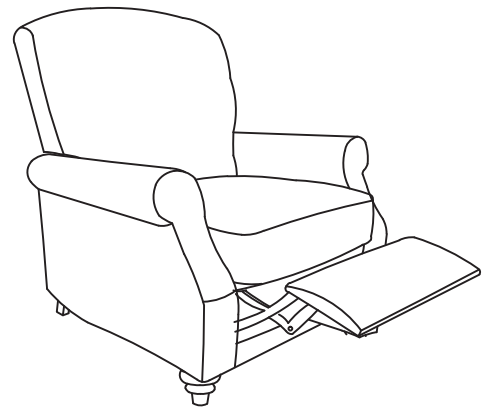
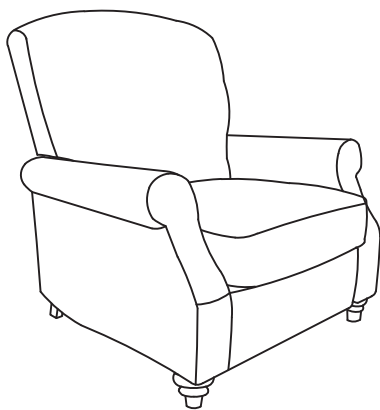

Your recliner style may differ from images. Care for your furniture by periodically tightening all legs.

**CAUTION:** Tighten all components securely before use. Failure to do so may result in personal injury.

About your furniture piece:

- Softening of foam is natural and will happen over time with use.
- Fabric will fade or discolor in direct sunlight. Minimize exposure to direct sunlight to extend the life of your furniture.
- Wood grain, knots, streaks, and color variation occur naturally in wood and are not considered defects.