

ASSEMBLY INSTRUCTIONS

IMPORTANT NOTE

****PLACE ALL PARTS ON A CLEAN AND SMOOTH SURFACE SUCH AS A RUG OR CARPET TO AVOID THE PARTS FROM BEING SCRATCHED**

****BEFORE YOU BEGIN, KINDY FOLLOW THE ASSEMBLY INSTRUCSTIONS STEP BY STEP**



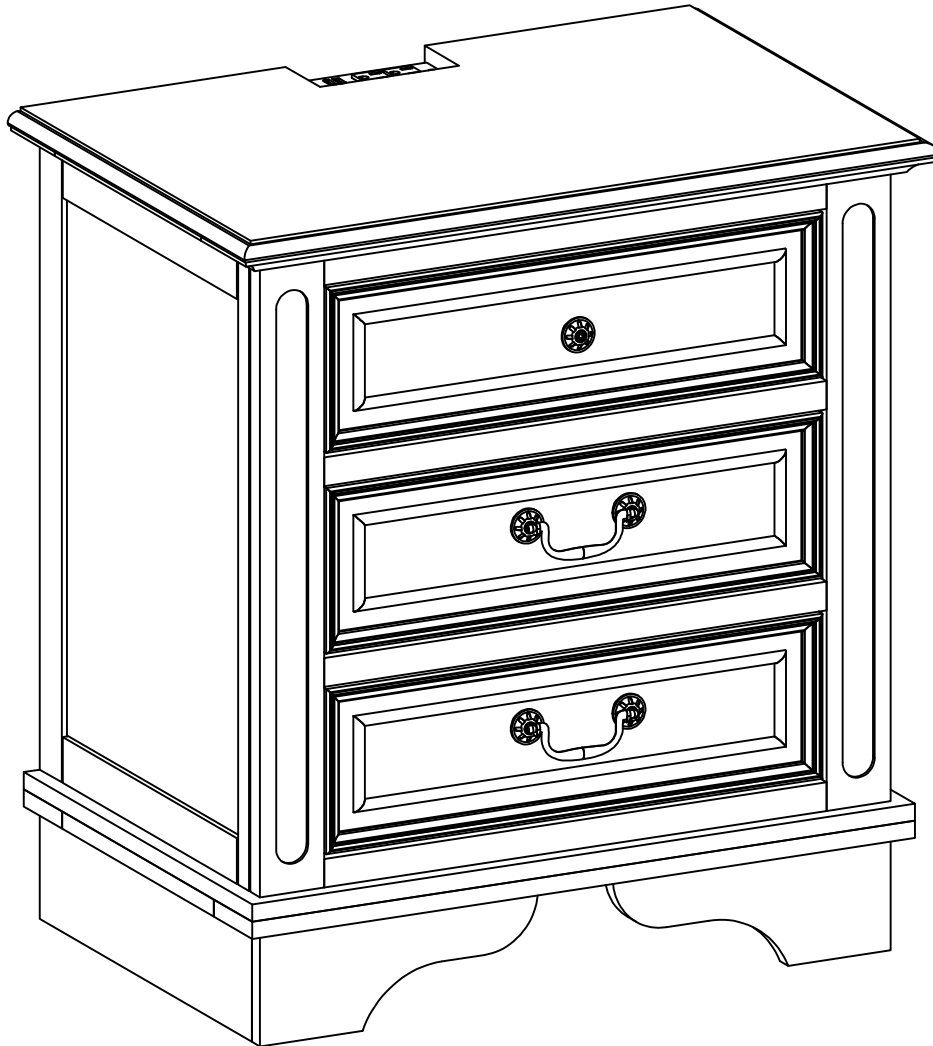







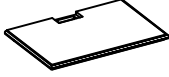
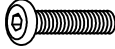
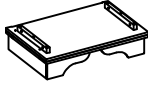

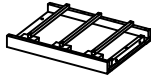

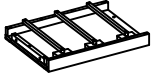











****DO NOT TIGHTEN ALL SCREWS AND BOLTS UNTIL THE TABLE IS FULLY SET-UP**



PLEASE DO NOT RETURN PRODUCT TO THE STORE

ASSEMBLY INSTRUCTIONS

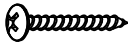
CARTONS ONLY ONE/HARDWARE LISTS

PART LISTS				HARDWARE LISTS			
NO	DESCRIPTION	SKETCH	Q'TY	NO	DESCRIPTION	SKETCH	Q'TY
A	TOP		1 PC	1	BOLT 1/4*30mm		8 PCS
B	BASE		1 PC	2	FLAT WASHER 1.2*Ø6.5*16mm		8 PCS
C	SIDE PANEL LEFT		1 PC	3	SPRING WASHER 1.2*Ø6.5*11mm		8 PCS
D	SIDE PANEL RIGHT		1 PC	4	ALLEN KEY K4*60		1 PCS
E	SUPPORT RAIL		4 PCS	5	POWER USB HUB		1 PCS
F	H-RAIL		1 PC	6	PLASTIC DRAWER STOP		6 PCS
G	BACK PANEL WITH HOLE		1 PC	7	SCREW Ø3.5*15mm		8 PCS
H	BACK PANEL		1 PC	8	SCREW Ø3.5*15mm		18 PCS
I	DRAWER FRONT 1 HOLE		1 PC	9	HANDLE		1 PCS
J	DRAWER FRONT 2 HOLE		2 PCS	10	HANDLE		2 PCS
K	DRAWER SIDE L		3 PCS	11	BOLT M4*20		5 PCS
L	DRAWER SIDE R		3 PCS	12	PLASTIC BARREL NUT Ø9x9.5		15 PCS
M	DRAWER BACK		3 PCS	13	SCREW Ø4*25mm		15 PCS
N	DRAWER BOTTOM		3 PCS	14	SCREW Ø4*40mm		15 PCS
O	DRAWER SUPPORT		3 PCS	15	WOOD DOWEL Ø6*20		36 PCS

ASSEMBLY INSTRUCTIONS

STEP 1

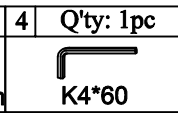
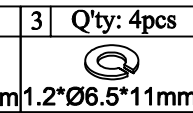
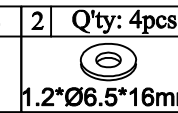
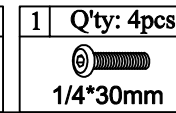
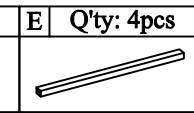
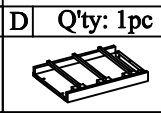
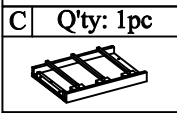
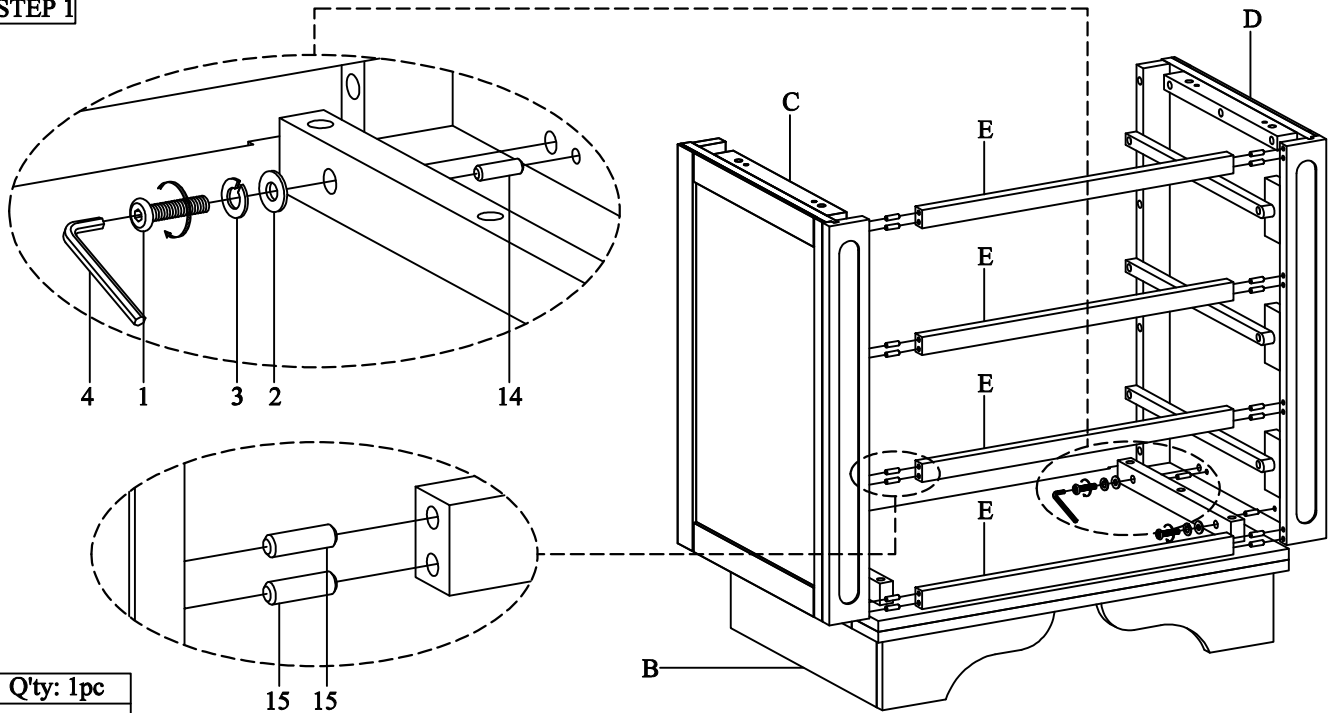



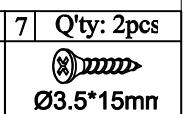
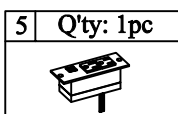
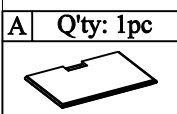
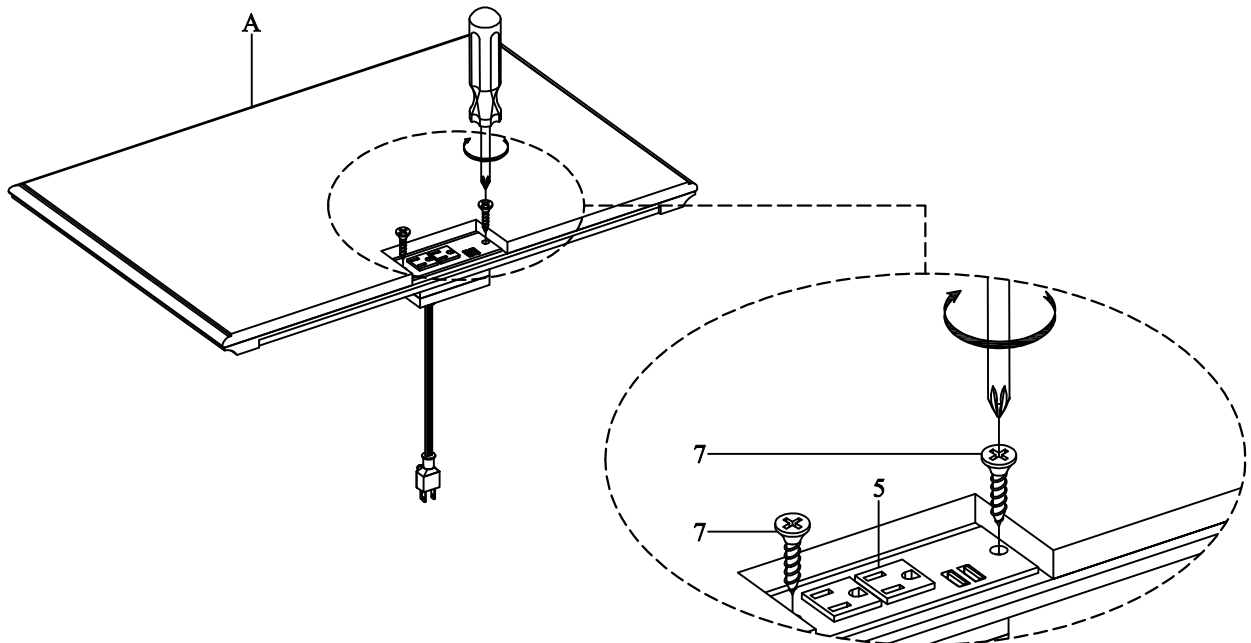



STEP 2

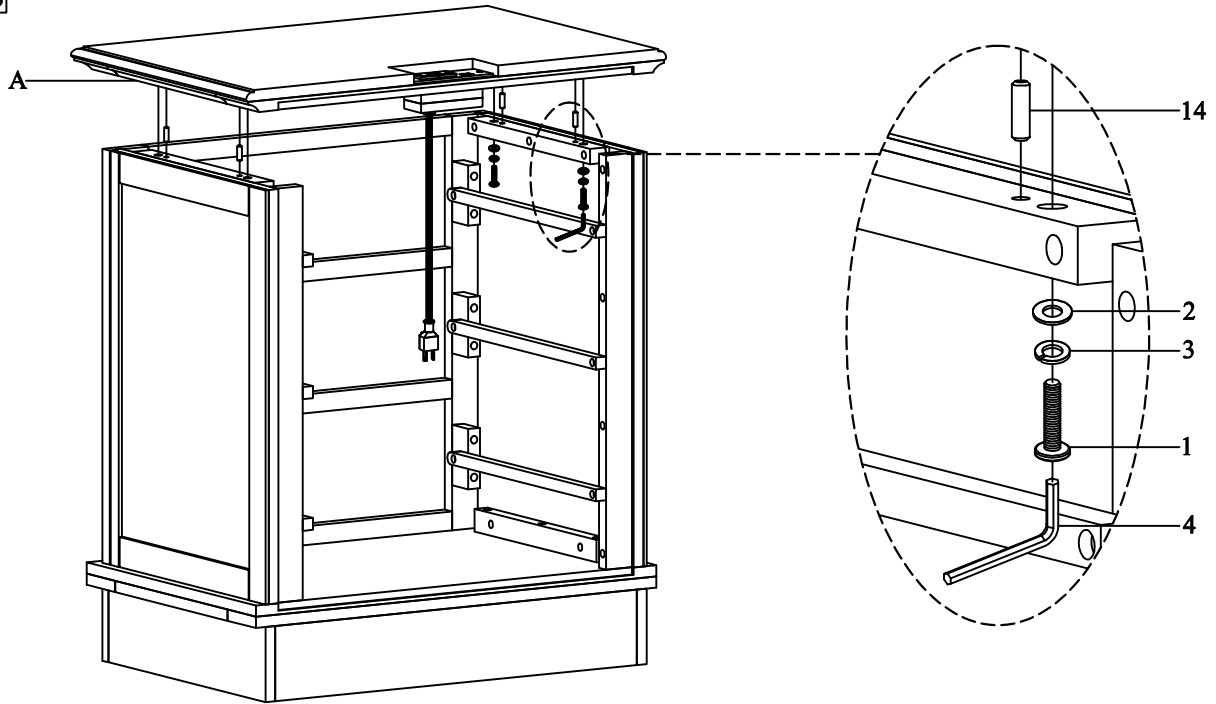

ASSEMBLY INSTRUCTIONS



STEP 3

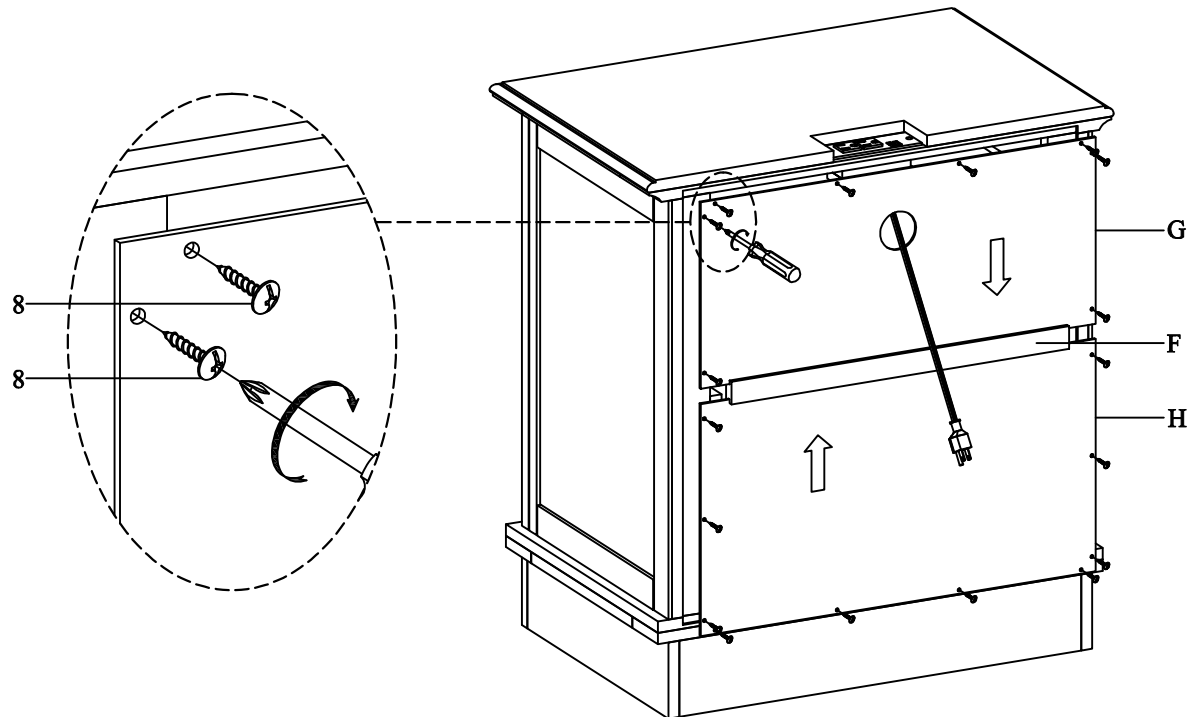

1	Q'ty: 4pcs	2	Q'ty: 4pcs	3	Q'ty: 4pcs	4	Q'ty: 1pc	15	Q'ty: 4pcs
	1/4*30mm		1.2*Ø6.5*16mm		1.2*Ø6.5*11mm		K4*60		Ø6*20

STEP 4



F	Q'ty: 1pc	G	Q'ty: 1pc	H	Q'ty: 1pc
					

8	Q'ty: 18pc
	Ø3.5*15mm

ASSEMBLY INSTRUCTIONS

STEP 5

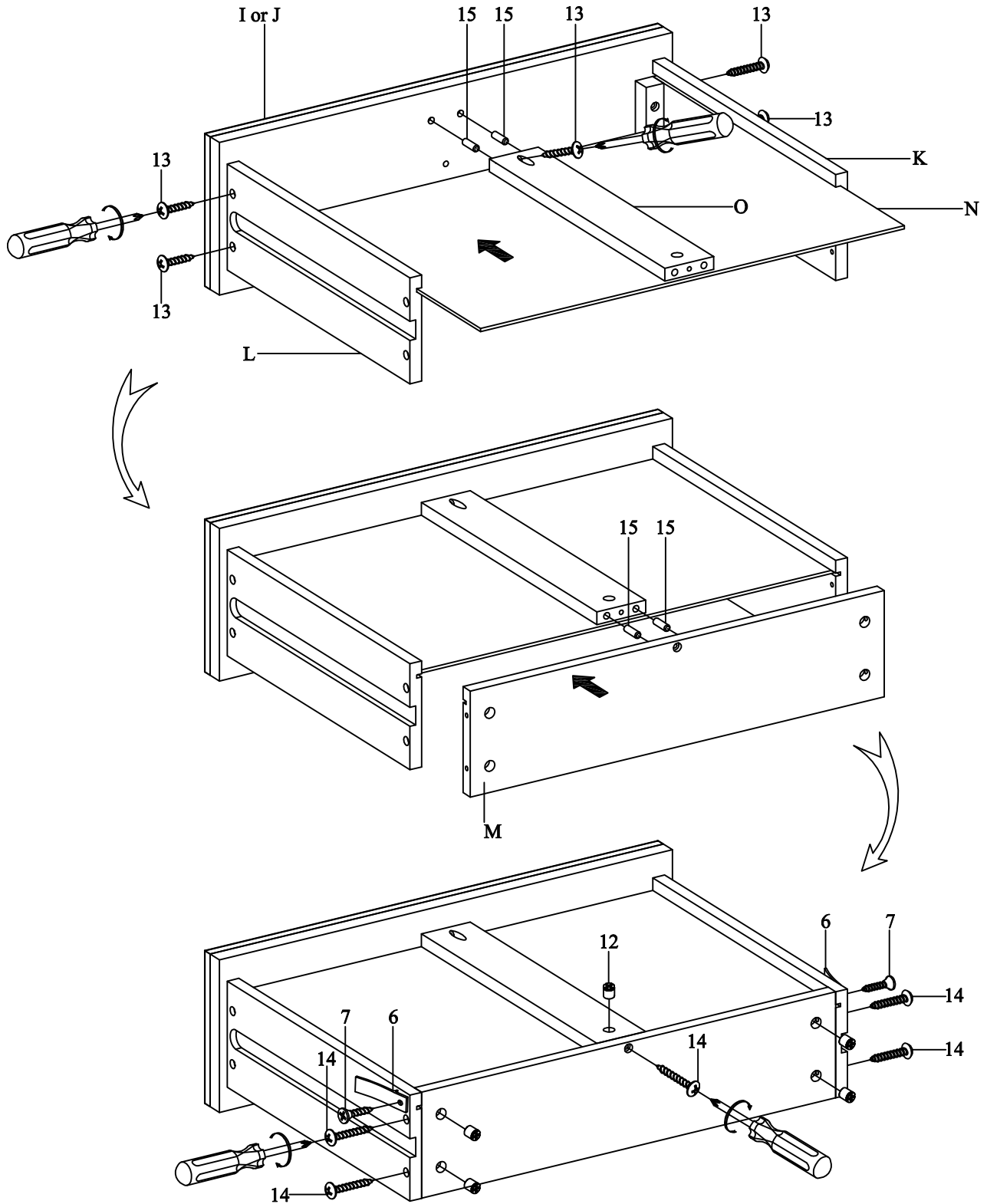



I	Q'ty: 1pc	J	Q'ty: 2pcs	K	Q'ty: 3pcs	6	Q'ty: 6pcs	7	Q'ty: 6pcs
L	Q'ty: 3pcs	M	Q'ty: 3pcs	N	Q'ty: 3pcs	O	Q'ty: 3pcs	12	Q'ty: 15pcs
								13	Q'ty: 15pcs
								14	Q'ty: 15pcs
								15	Q'ty: 12pc

ASSEMBLY INSTRUCTIONS

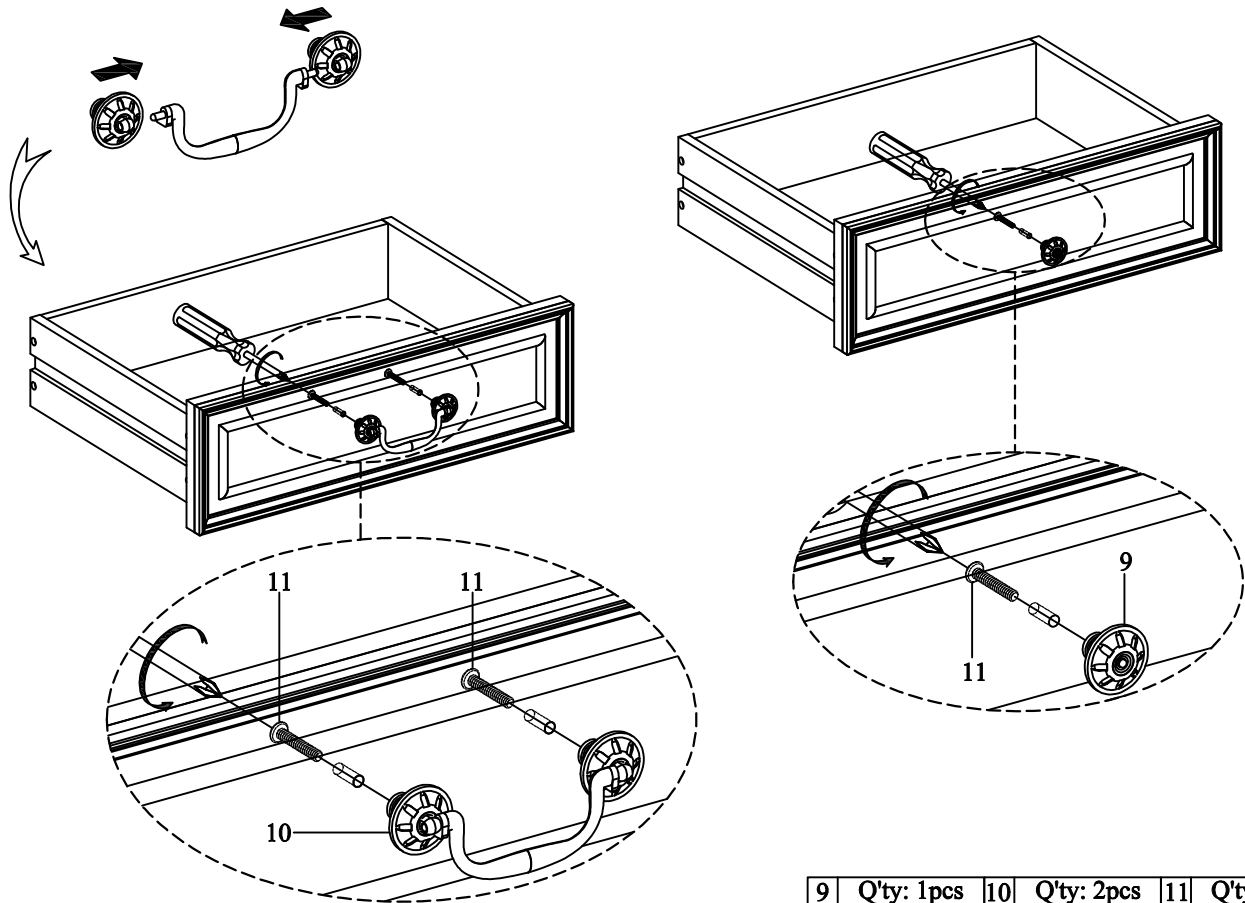
STEP 6



9	Q'ty: 1pcs	10	Q'ty: 2pcs	11	Q'ty: 5pcs
					
					Ø6*20

STEP 7

