

Assembly Instruction

CAUTION: Read instruction carefully and turn electricity off at main circuit breaker panel before beginning installation.

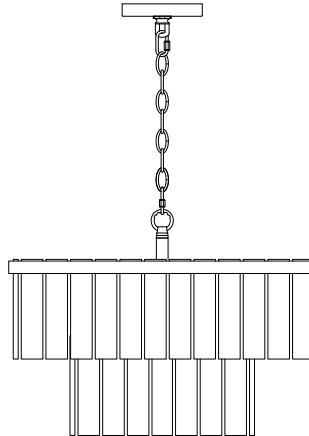

Care and Cleaning









To clean the outside of the fixture, use a dry or slightly dampened clean cloth (use clean water, never a solvent) to wipe the surface of the fixture.

To clear the inside of the fixture, first disconnect power to the fixture by turning off the circuit breaker or by removing the fuse at the fuse box. Next, use a dry or slightly dampened clean cloth (use clean water, never a solvent) to wipe the interior surface of the fixture.

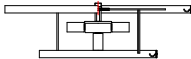
Do not use any cleaners with chemical, solvents or harsh abrasives. Use Only a dry soft cloth to dust or wipe carefully.

Estimated Assembly Time: 30 minutes

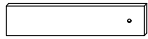
Part List and Hardware List

PIECE	DESCRIPTION	PICTURE	QUANTITY	PIECE	DESCRIPTION	PICTURE	QUANTITY
A	Mounting bar		1X	F	Central rod		1X
A1	Outlet box screw		2X	G	Fixture body		1X
B	Canopy		1X				
C	Collar loop		1X	H	Light bulbs		4X
D	Canopy ring		1X	I	Marble		59X
E	Chain		1X	J	Wire nut		3X

Installation

Step 1

1. Attach the central rod (F) to the fixture body (G).

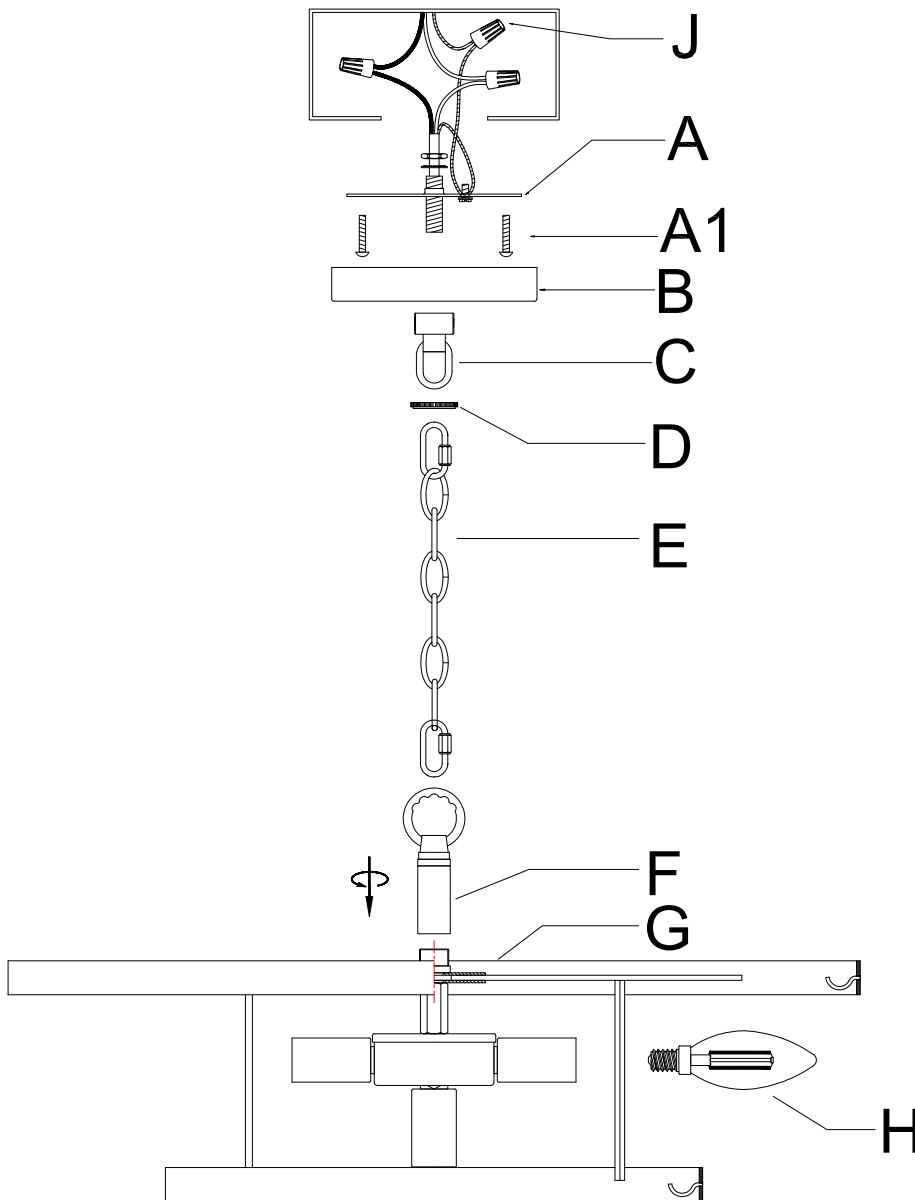

Step 2 Wire connection

Connect, Hot, Black or Red outlet Supply Wire to:	Connect, Neutral, White Outlet Supply Wire to:
Black	White
*Parallel Cord(round&smooth)	*Parallel Cord(square&ridged)
Clear, Brown, Gold or Black without Tracer(colored stripes)	Clear, Brwn, Gold or Black without Tracer(colored stripes)
Insulated Wire(not green)with copper metal conductor	Insulated Wire(not green)with Silver metal conductor

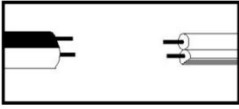

*Note: When parallel wire(SPTI&SPTII)is used. The neutral wire is square shaped and ridged and the hot wire will be round in shape and smooth.(See illustration on left)

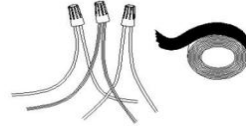

Grounding Instructions:

- For installation in the United States: Wrap ground wire from outlet box around green ground screw on mounting bracket, no less than 2" from wire end. Tighten ground screw. If fixture is supplied with a ground wire, connect to outlet ground wire with a wire connector.
- For installation in Canada: If fixture is supplied with ground wire, wrap ground wire around green grounding screw on mounting bracket. Tighten ground screw.

Step 3

- Attach the mounting bar(A) to the junction box with outlet box screw (A1)
- Attach the canopy (B) to the mounting bar (A), secure with the collar loop (C) and canopy ring(D)
- Connect the metal chain to the collar loop (C) on the top and the fixture loop on the bottom.

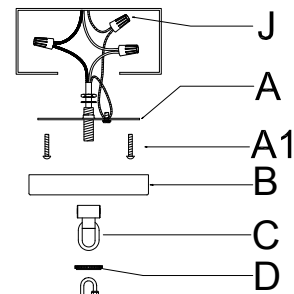

Step 4

- Raise the marble (I) hang on the small hook of the fixture body (G).
- Install the light bulb (H) to the socket.

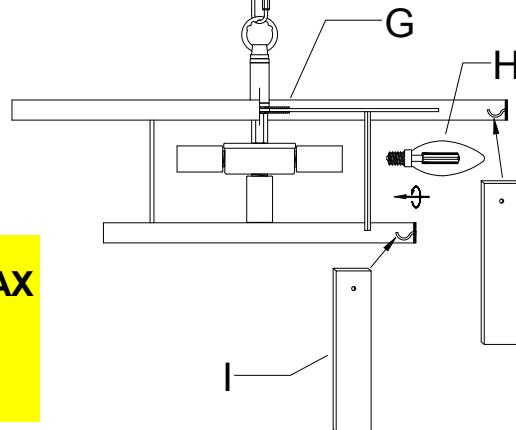

PLEASE USE DIMMABLE TYPE "B" BULB MAX 40-WATT OR LED BULB MAX 9-WATT THERE IS LED 4-WATT BULB IN THE BOX

Step 5

Consult a qualified electrician to ensure correct branch circuit conductor.

ENJOY YOUR LAMP