

GRETEL LEATHER L-SHAPED SECTIONAL

SFV2414A

Assembly Instructions

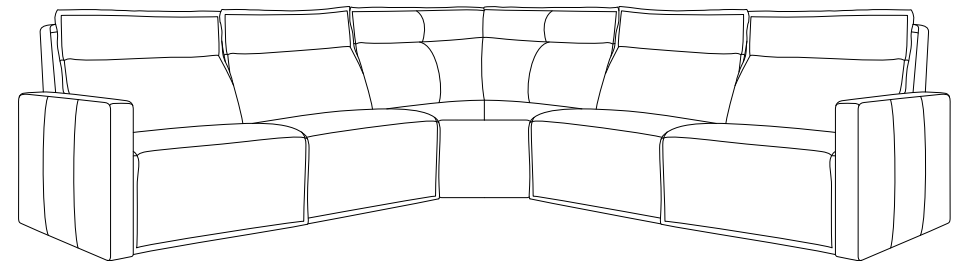

Need help?

Feel free to contact us via emails or call
if you have any specific question!

Contact us:

cs@safavieh.com
866-422-9070

SAFAVIEH
C O U T U R E

Thanks for bringing Safavieh Couture into your home

Everything we make is incredibly simple to set up, including your new sofa. You won't need any additional tools.

Parts List

A x 1
LEFT BACKREST

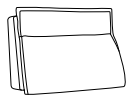

B x 1
LEFT SEAT

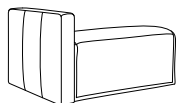

C x 1
LEFT NO ARM



D x 1
CORNER

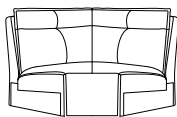

E x 1
RIGHT NO ARM



F x 1
RIGHT BACKREST



G x 1
RIGHT SEAT

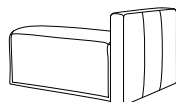

1

Place the Left Backrest (A) on top of Left Seat (B) with the metal plates on the same side as shown below.

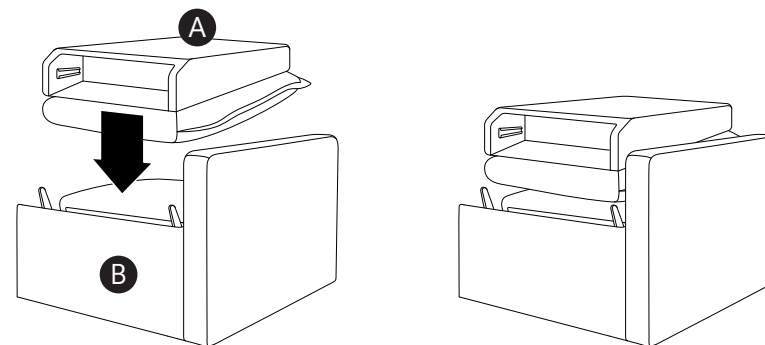

2

Carefully align the metal plates on the Left Backrest (A) to the metal plates on the Left Seat (B) and then push down until they connected half way.

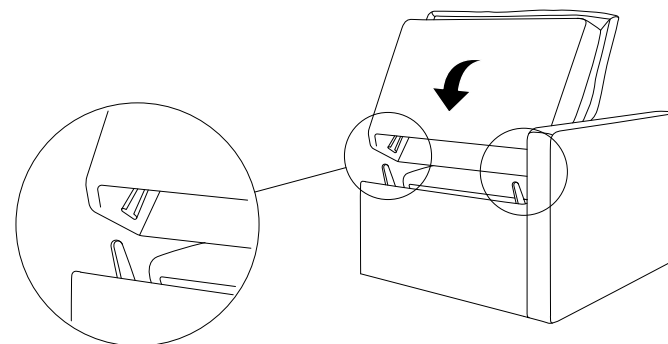

3

Push the Left Backrest (A) down firmly until each side is locked into place and an audible “click” noise is heard.

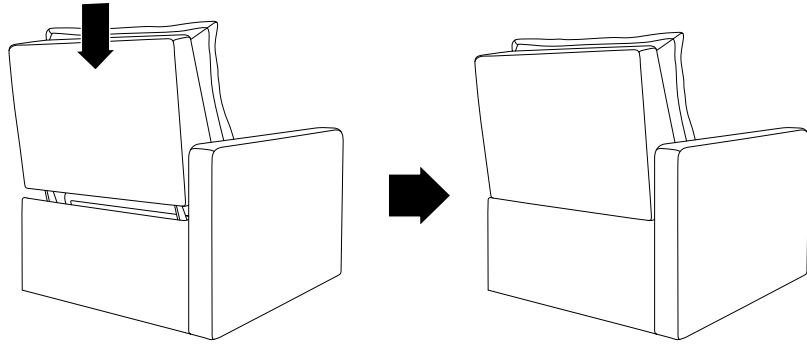

4

Repeat steps 1 to 3 for Right Backrest (F) and Right Seat (G).

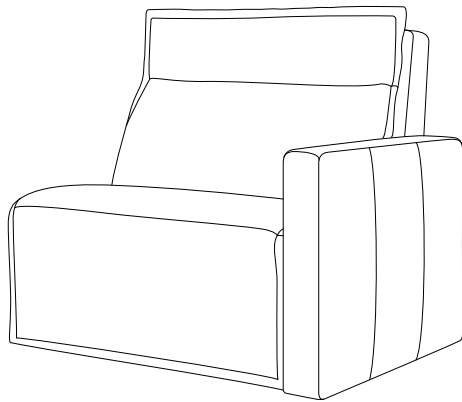

5

With the assistance of a second person, carefully lift and align the metal plates on Left Seat (B) to the metal plates on the Left No Arm Seat (C). Repeat this step to connect the Left No Arm Seat (C) to the Corner Seat (D), then to the Right No Arm Seat (E), then to the Right Seat (G).

Note: Hardware may loosen over time. Periodically check that all connections remain tight and adjust as needed.

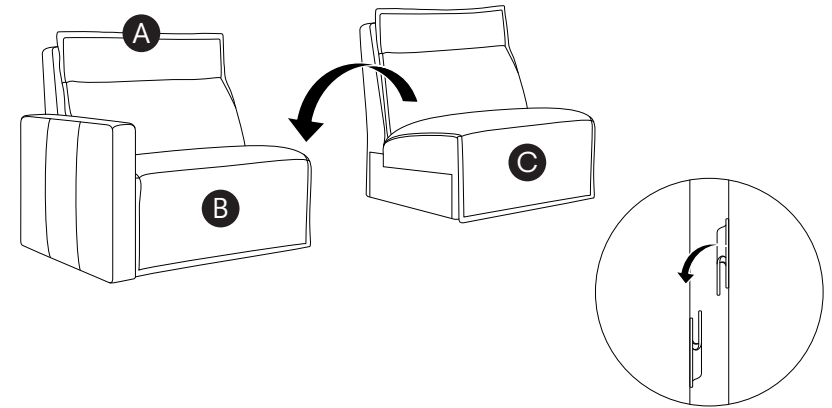

6

Place the sofa in the place where you will use it. We'd love to see it – just tag us (we're @safavieh) and use the hashtag #safavieh on Instagram!

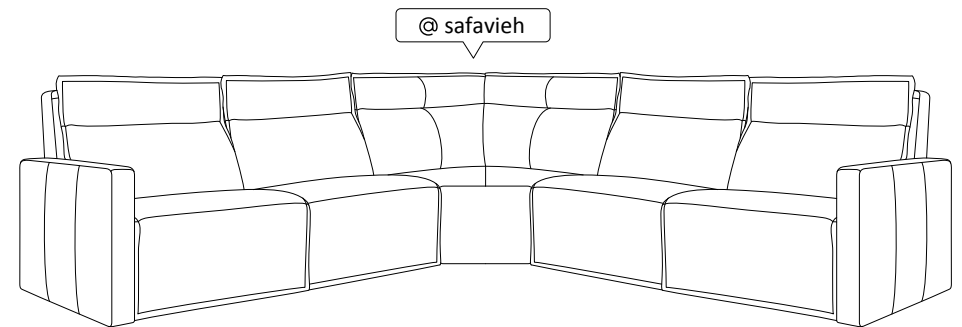

CONNECTING TO POWER

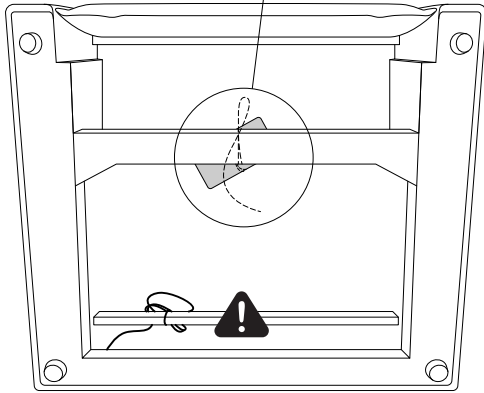
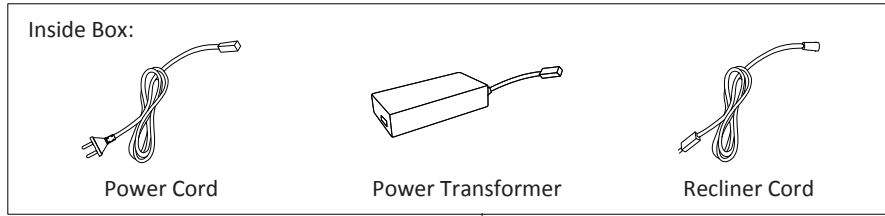

WARNING: Do not cut the cable ties as it may damage the wires inside. The ties are purposely to hold cables in place.

