

ASSEMBLY INSTRUCTION

Friendly Reminder:

- 1.This sofa is packed in 3 boxes. Please assemble it After all boxes are received.
- 2.As the cushions are all vacuum compressed,there will be some wrinkles. Please give your cushions up to 72 hours to reach its original size and the wrinkles will basically disappear.
- 3.Please do not open the compressed packages until your sofa frame is completely assembled.

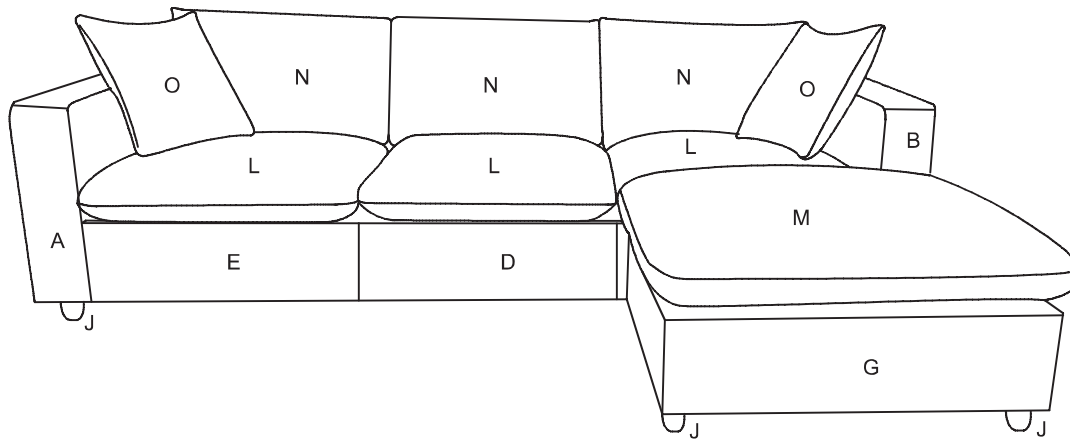









Return & Warranty policy:













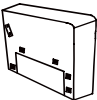
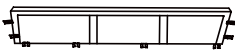



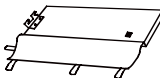

- We strive to offer the highest quality products,and we also try our best to satisfy each and every customer that orders from us with replacement parts or service as needed.
- If the item is damaged or defective, please take photos as evidence for replacements and refunds.
- Please do not return to store,contact the seller if you have any troubles with this product.

ASSEMBLY INSTRUCTION



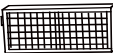

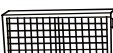
HARDWARE LIST

NO	DESCRIPTION	SKETCH		NO	DESCRIPTION	SKETCH	QTY
①	Bolt M8*100		2 PCS	⑥	Gasket Ø22		42 PCS
②	Bolt M8*35		14 PCS	⑦	Allen key M5		1 PCS
③	Bolt M8*60		8 PCS	⑧	Wrench		1 PCS
④	Bolt M8*45		4 PCS	⑨	Slider		1 PCS
⑤	Nut M8*14		14 PCS	⑩	Gloves		2 PCS

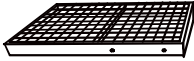
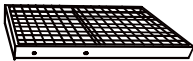
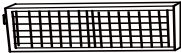
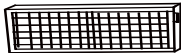

PARTS LIST

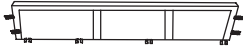
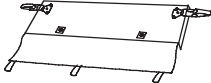
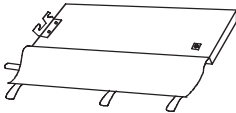
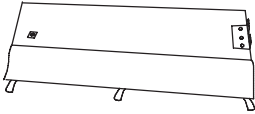
NO	DESCRIPTION	SKETCH	QTY	NO	DESCRIPTION	SKETCH	QTY
A	Armrest (Left)		1 PCS	I1	Left Seat frame		1 PCS
				I2	Right Seat frame		1 PCS
B	Armrest (Right)		1 PCS	K	Backrest cover		1 PCS
C1	Right tailgate		1 PCS	L	Seat cushion		3 PCS
C2	Left tailgate		1 P C S				
D	Middle front baffle		1 PCS	M	Ottoman cushion		1 PCS
E	Left front baffle		1 PCS	N	Backrest cushion		3 PCS
F	Right front baffle		1 PCS	O	Pillow		2 PCS
G	Ottoman frame		1 PCS	P	Front supporting foot		1 PCS
H1	Left Back frame		1 PCS	Q	Rear support foot		1 PCS
H2	Right Back frame		1 PCS				
J	Leg		8 PCS				

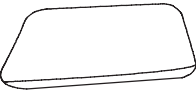
PARTS LIST WF310486

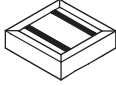

NO	DESCRIPTION	SKETCH	QTY
I1	Left Seat frame		1
I2	Right Seat frame		1
H1	Left Back frame		1
H2	Right Back frame		1
L	Seat cushion		1
K	Backrest cloth cover		1
D	Middle front baffle		1
E	Left front baffle		1
F	Right front baffle		1
C1	Right tailgate		1
C2	Left tailgate		1
M	Ottoman cushion		1
Assembly instruction			1

PARTS LIST WF310487

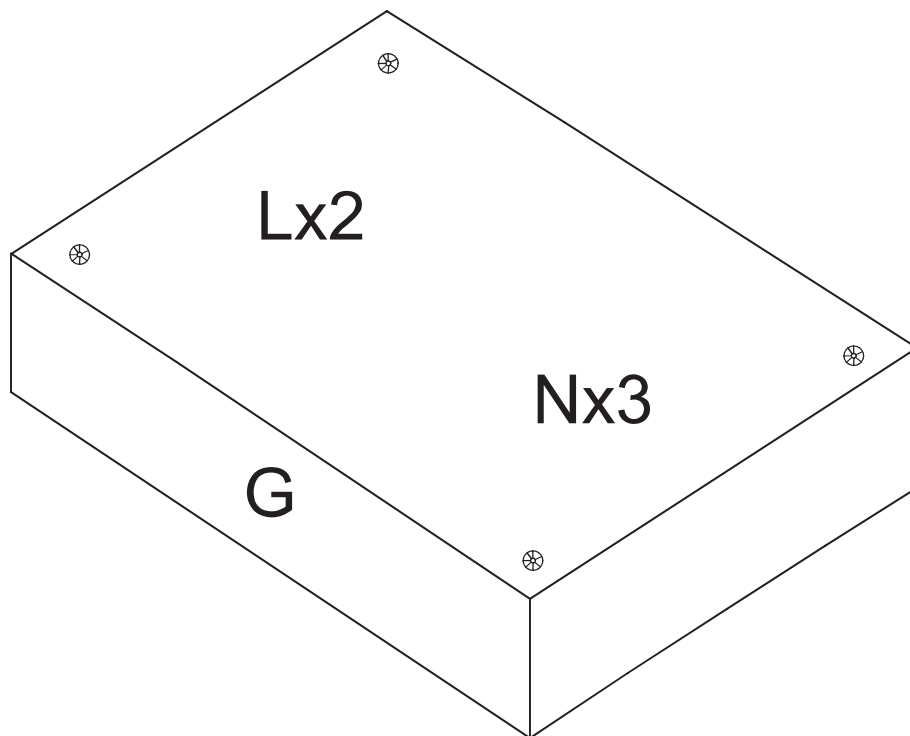



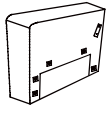
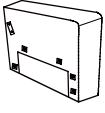







NO	DESCRIPTION	SKETCH	QTY
G	Ottoman frame		1
L	Seat cushion		2
N	Backrest cushion		3



PARTS LIST WF310488

NO	DESCRIPTION	SKETCH	QTY
A	Armrest (Left)		1
B	Armrest (Right)		1
O	Pillow		2

Hardwares

①x2	②x14	③x8	④x4	⑤x14	⑥x42	⑦x1	⑧x1	⑨x1	⑩ x2
									
Jx8	Px1	Qx1							
	Front supporting foot 	Rear support foot 							

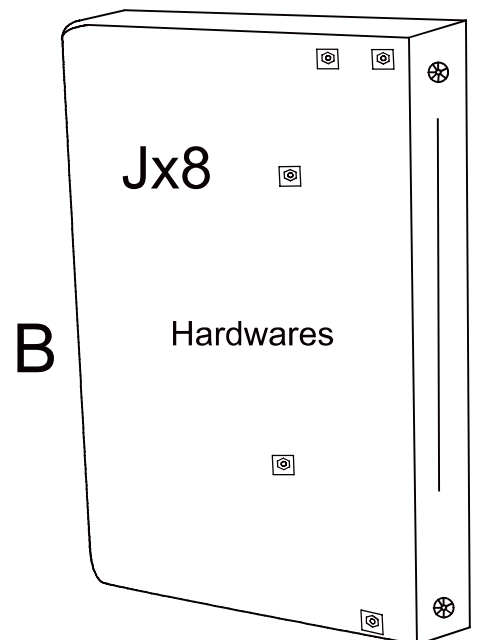
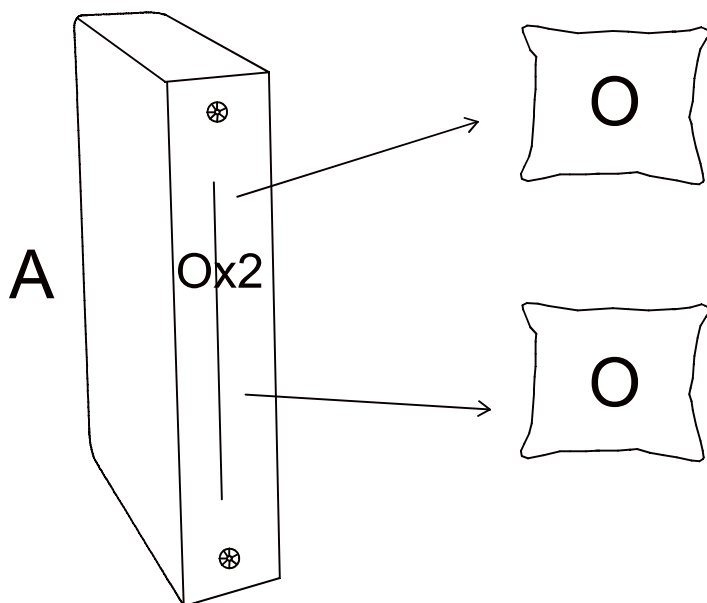

DIAGRAM1: 1.Please wear gloves before installation.



2.Connect Right tailgate(Part C1)and Left tailgate (Part C2)with Slider(Hardware 9).

⑨		1 PCS
⑩		2 PCS

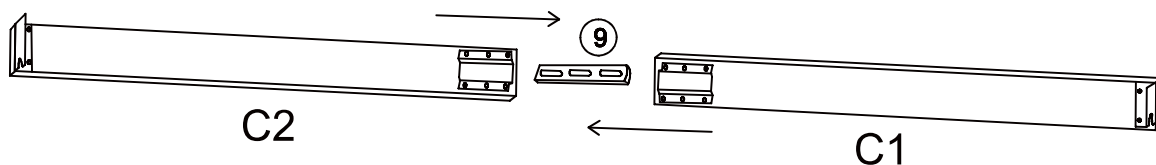

DIAGRAM2:

Tighten the Armrest Left(Part A), Armrest Right (Part B), Otoman frame (Part G)with 8 Legs(Part J)partially in a clockwise direction.

J		8 PCS
---	--	-------

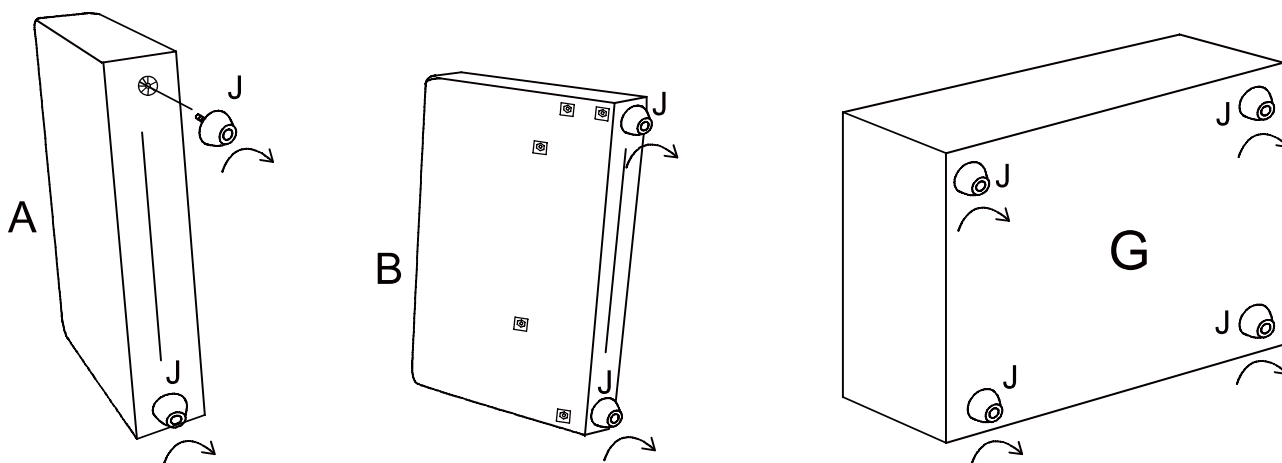







DIAGRAM3:

After opening the rack with Left backrest H1 and right backrest H2, Use the hex key M5(Hardware 7) to Connect with 2 Bolts M8*100, 4 washers (Ø22) and 2 nuts M8*14(Hardware 5). 2 Bolts M8*60(Hardware 3) and 2 nuts M8*14(Hardware 5) and 4 washers Ø22(Hardware 6) connect the mount (Left frame I1 and right frame I2).

①	 M8*100	2PCS
③	 M8*60	2PCS
⑤		4PCS
⑥		8PCS
⑦		1PCS
⑧		1PCS

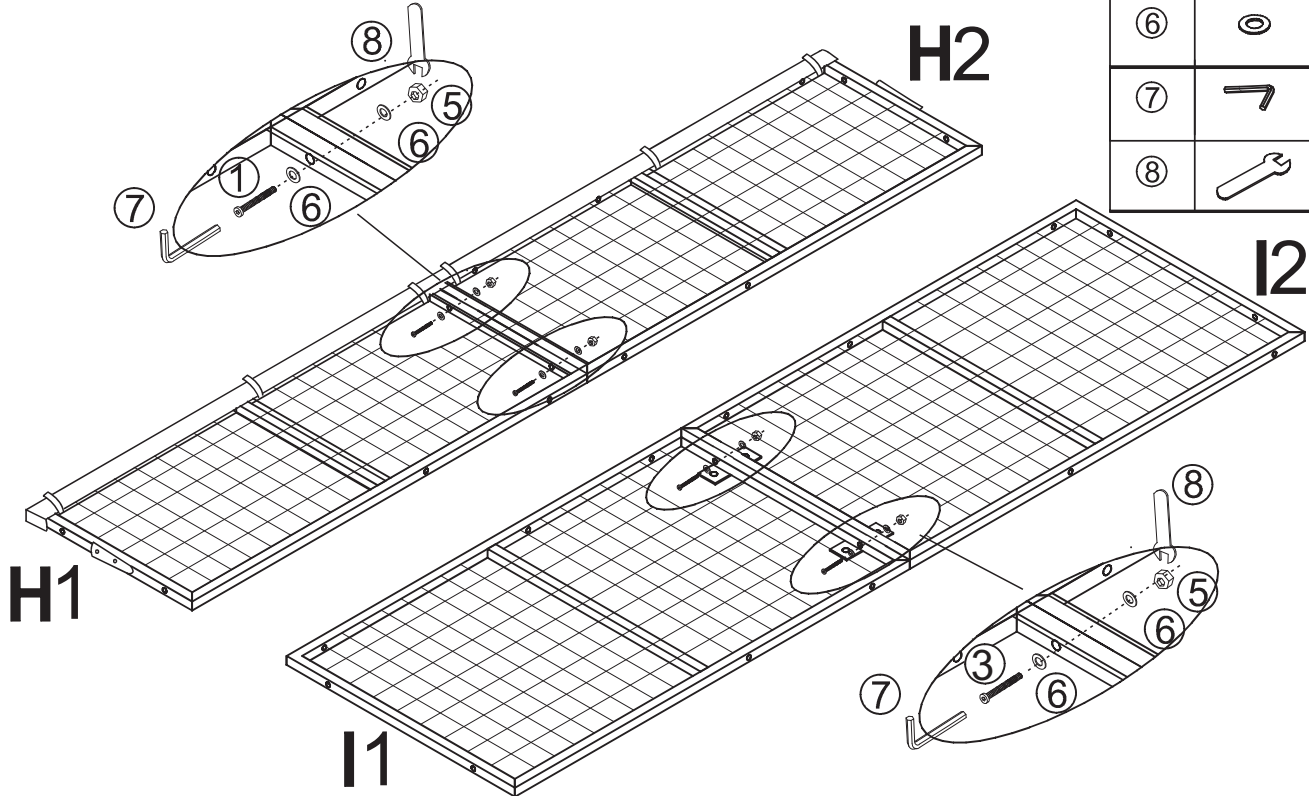



DIAGRAM4:

Attach the Seat frame (Part I) by using 2 Bolts M8*60(Hardware3) and 2 Nuts M8*14 (Hardware 5),4 Gaskets Ø22(Hardware 6).

Attach the Seat frame (Part I) to the Armrest (Left) (Part A) by using 2 Bolts M8*45 (Hardware 4), 2 Gaskets Ø22(Hardware 6).

Attach the Seat frame (Part I) to the Armrest (Right) (Part B) by using 2 Bolts M8*45 (Hardware 4), 2 Gaskets Ø22(Hardware 6).

④	 M8*45	4PCS
⑥		4PCS

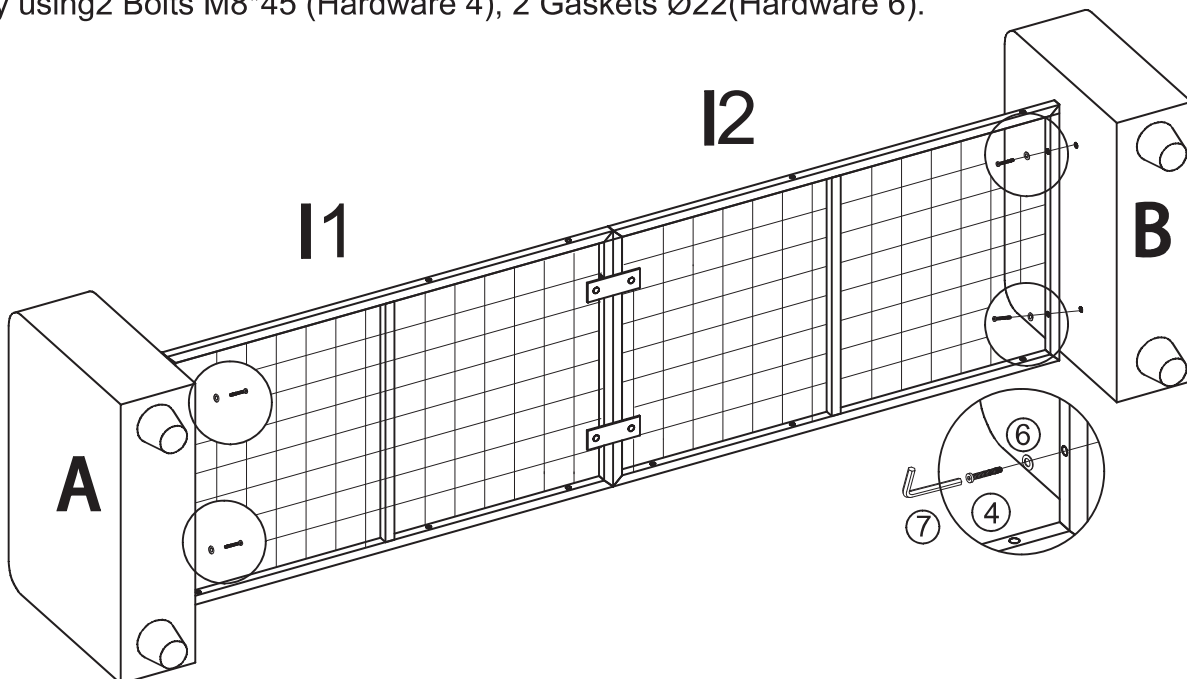





DIAGRAM5:

Secure the Rear support foot (Part Q) to the Seat frame (Part I) by 2 Bolts M8*35, 2 Nuts M8*14 and 4 Gaskets Ø22. (Hardware 2 +5 +6). Secure the Front support foot (Part P) to the Seat frame (Part I) by 2 Bolts M8*35, 2 Nuts M8*14 and 4 Gaskets Ø22. (Hardware 2+5+6).

②	 M8*35	4PCS
⑤		4PCS
⑥		8PCS

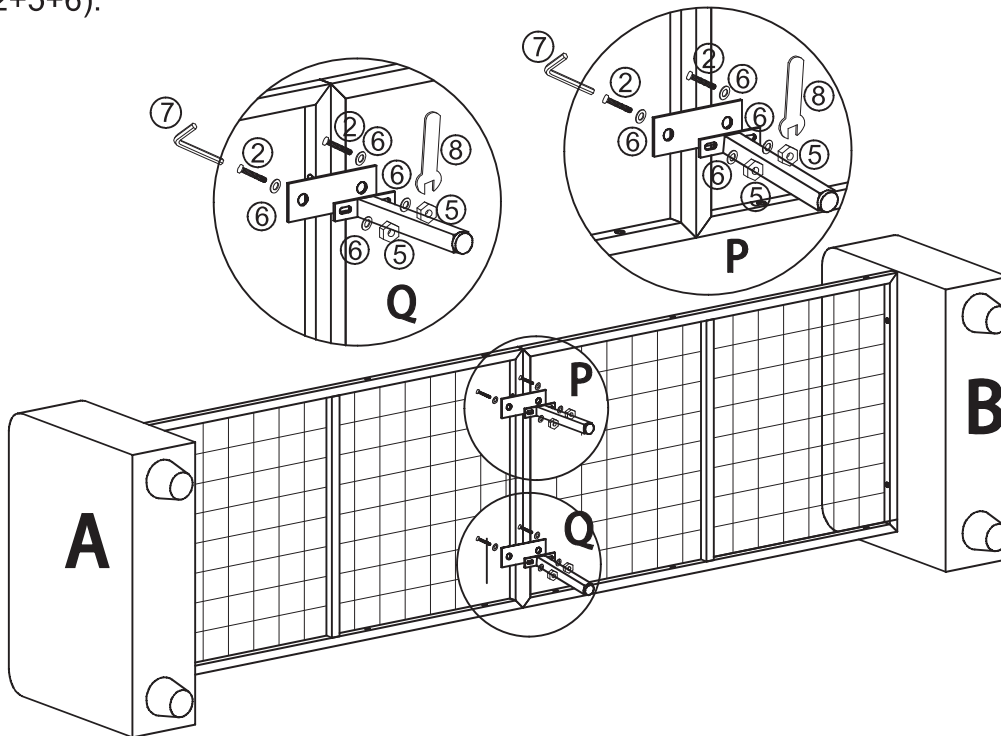



DIAGRAM6:

Tighten 2 bolts M8*35 and 2 Gaskets Ø22 (Hardware 2+6) 50% to the inside with Armrest (left)(Part A) and Armrest (right)(Part B). Hook the Right tailgate and Right tailgate(Part C1+C2) to the bolts M8*35 and tighten the bolts M8*35(hardware 2+6).

②	 M8*35	2PCS
⑥		2PCS

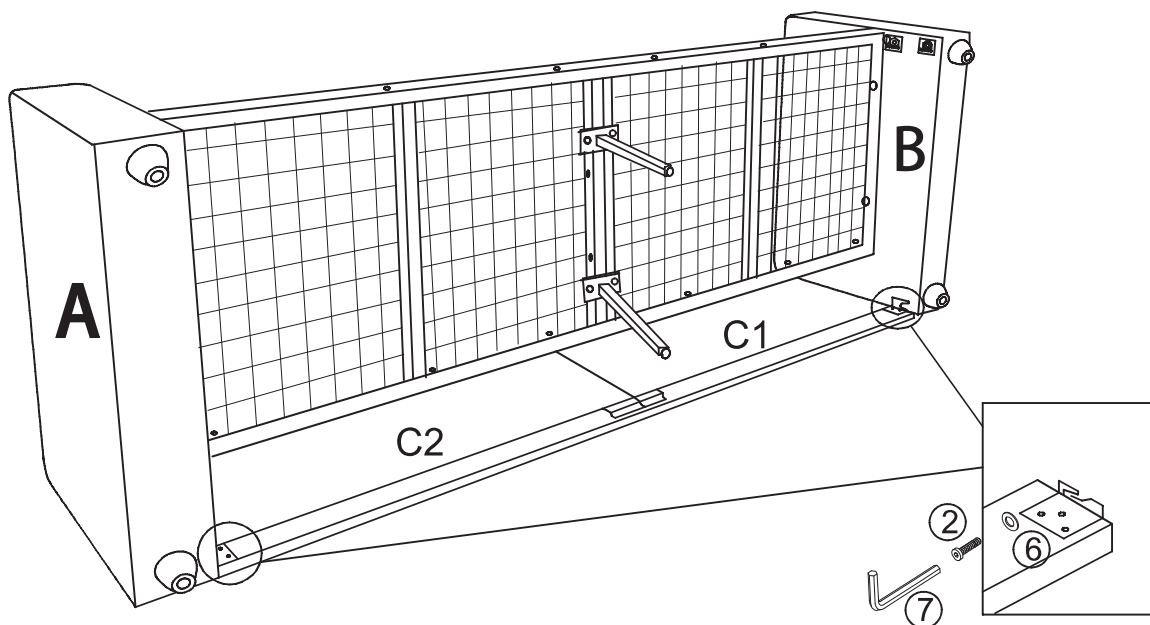

DIAGRAM7:

Align Back frame (Part H) position behind Armrest (Left) and Armrest (Right) (PartA+B)and hang it as shown in the figure,insert the Back frame (Part H) into the left and right Armrests.

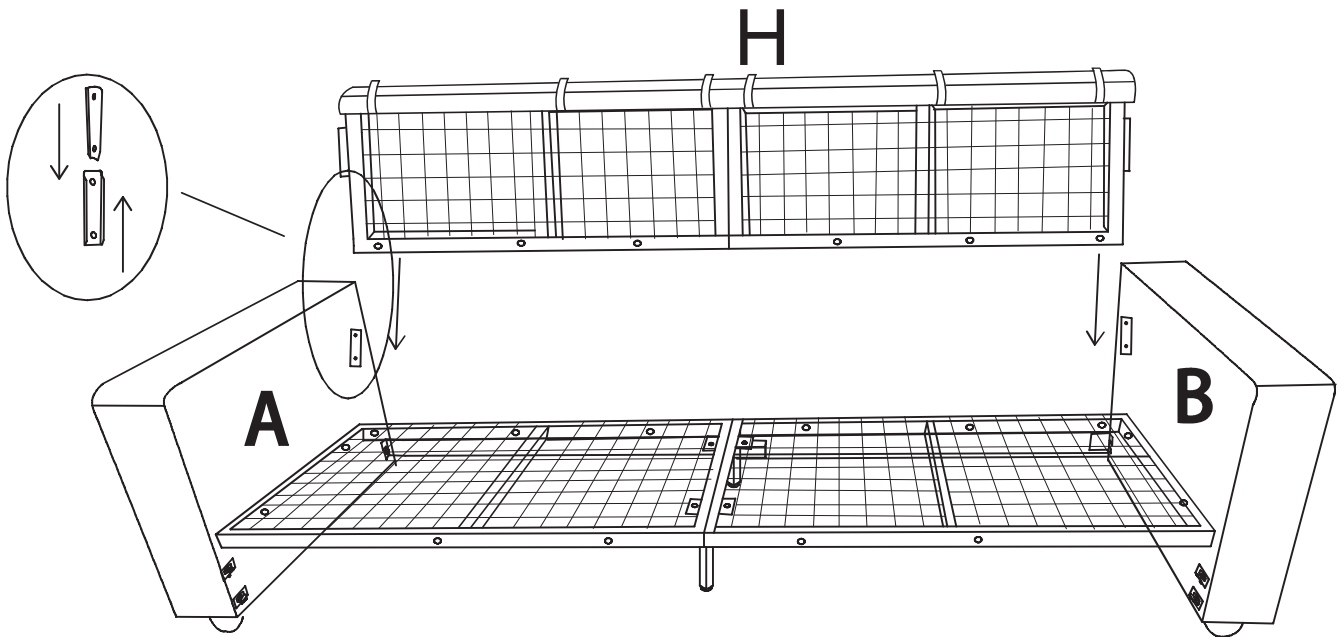





DIAGRAM8:

Connect Back frame (Part H) with Seat frame(Part I) by 6 Bolts M8 *60 and 6 Nuts M8*14, 12 Gaskets Ø22.(Hardware 3+5+6) .

③	 M8*60	6PCS
⑤		6PCS
⑥		12PCS

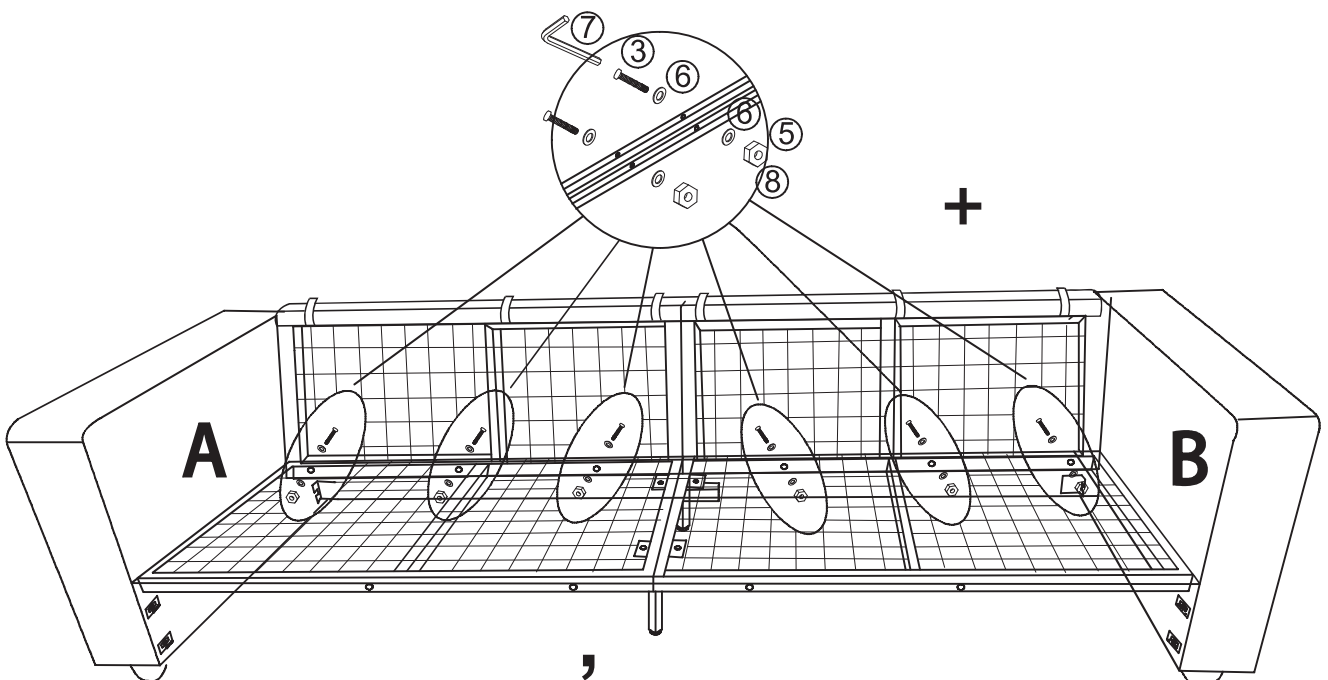



DIAGRAM9:

Use 4 M8*35 Bolts and 4 Gaskets Ø22(Hardware 2+6) on the inside of the Armrest to secure 50% screws (Part A+B).

Hook the Left front baffle and Right front baffle (Part E +F) to the M8*35 Bolts (Hardware 2) and tighten the M8*35 bolts by using the wrench M5 Hardware 7.

Connect the Left front baffle, Middle front baffle and Right front baffle (Part E+D+F) to the Seat frame (Part I) by using 4 Bolts M8*35 (Hardware 2) and 4 Gaskets Ø22(Hardware 2+6).

②	 M8*35	8PCS
⑥		8PCS

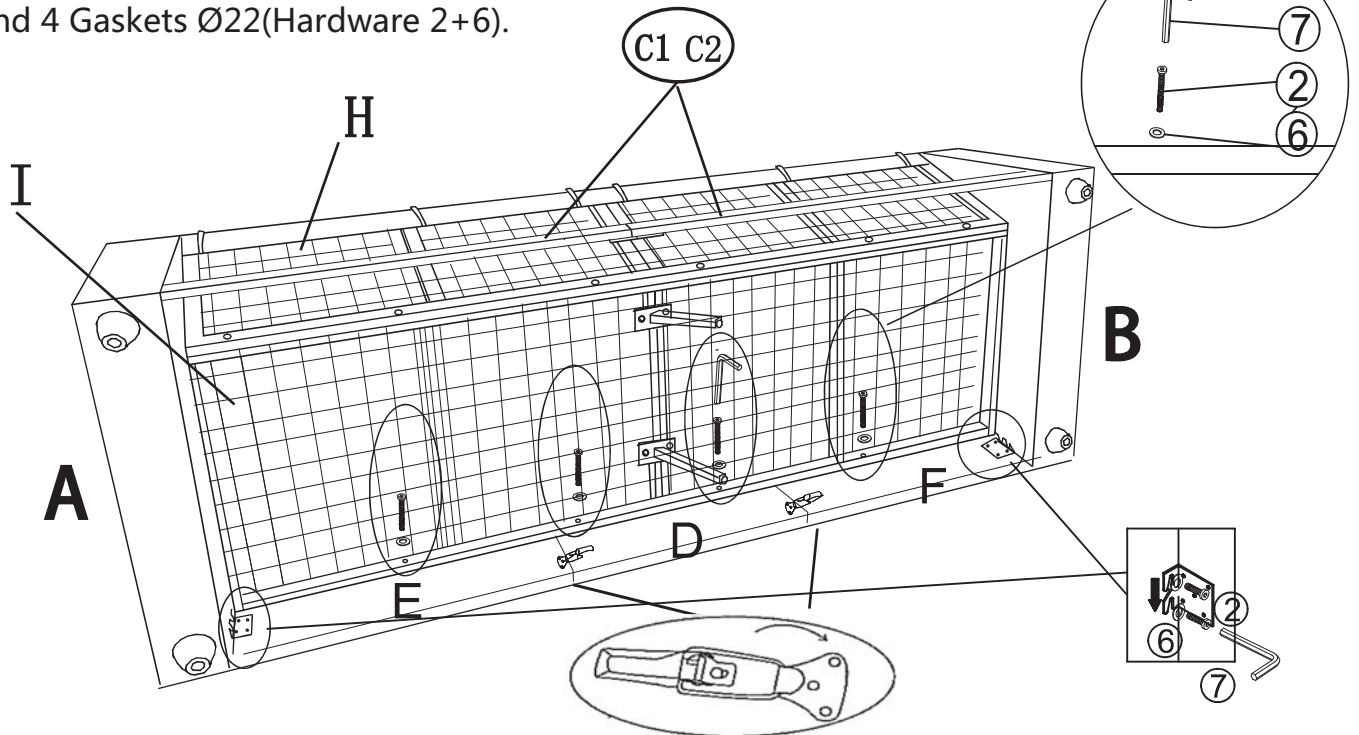

DIAGRAM10:

Place the Backrest cover (Part K) over the Back frame (Part H), attach the fabric strip to the Seat frame (Part I).

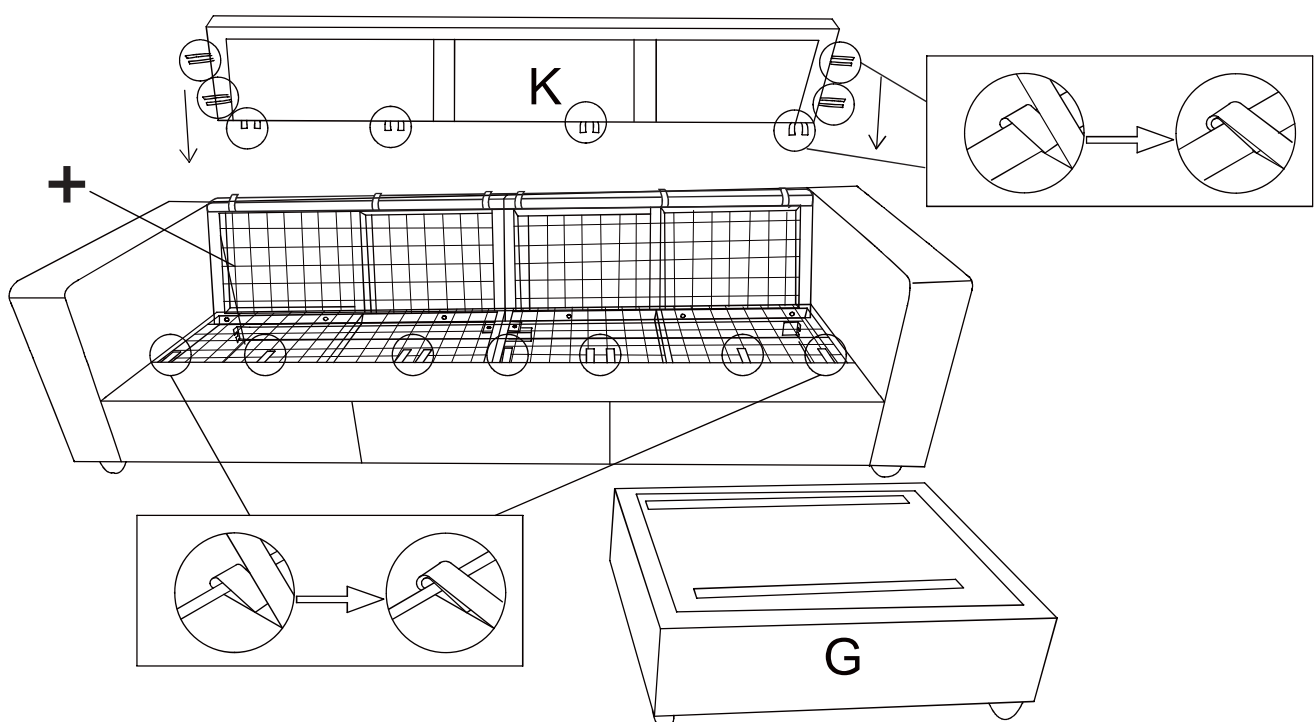

DIAGRAM11:

Place Seat cushions (Part L*3) Backrest cushion (Part N*3) Ottoman cushion(Part M*1)
on the sofa.

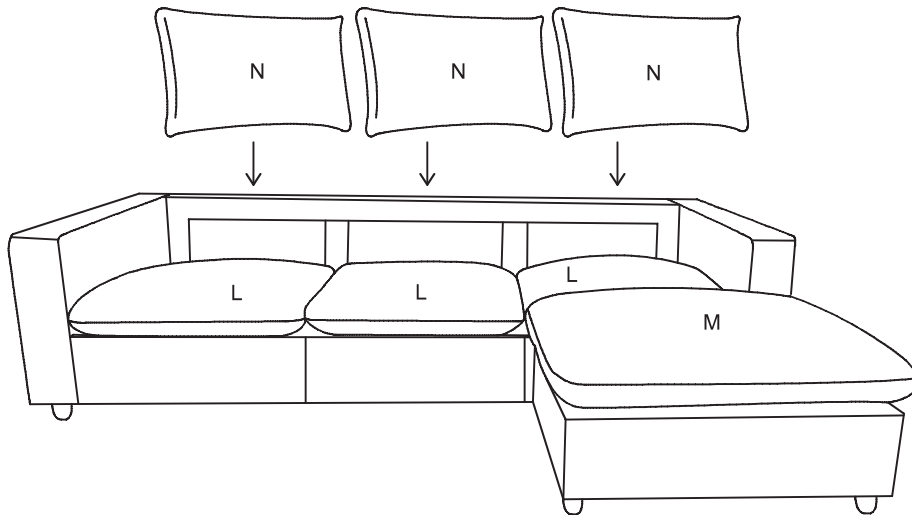

DIAGRAM12:

