

MAINTENANCE AND WARNING

- Keep furniture away from heat sources.
- Do not clean furniture with harsh cleaner or polishes. Do not use detergents, Solvents, abrasives, spray packs or leather cleaner. Use non-color mild soap with warm water to clean spills (Mix 1:10 soap to water)
- Do not place furniture under direct sunlight, material will possibly fade over time.
- Do not use on site dry Cleaning machine. Children should not climb or jump on the furniture.
- Do not write on furniture that is not protected by a padded barrier .
- Not for commercial use, only for residential use.

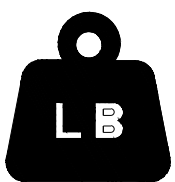



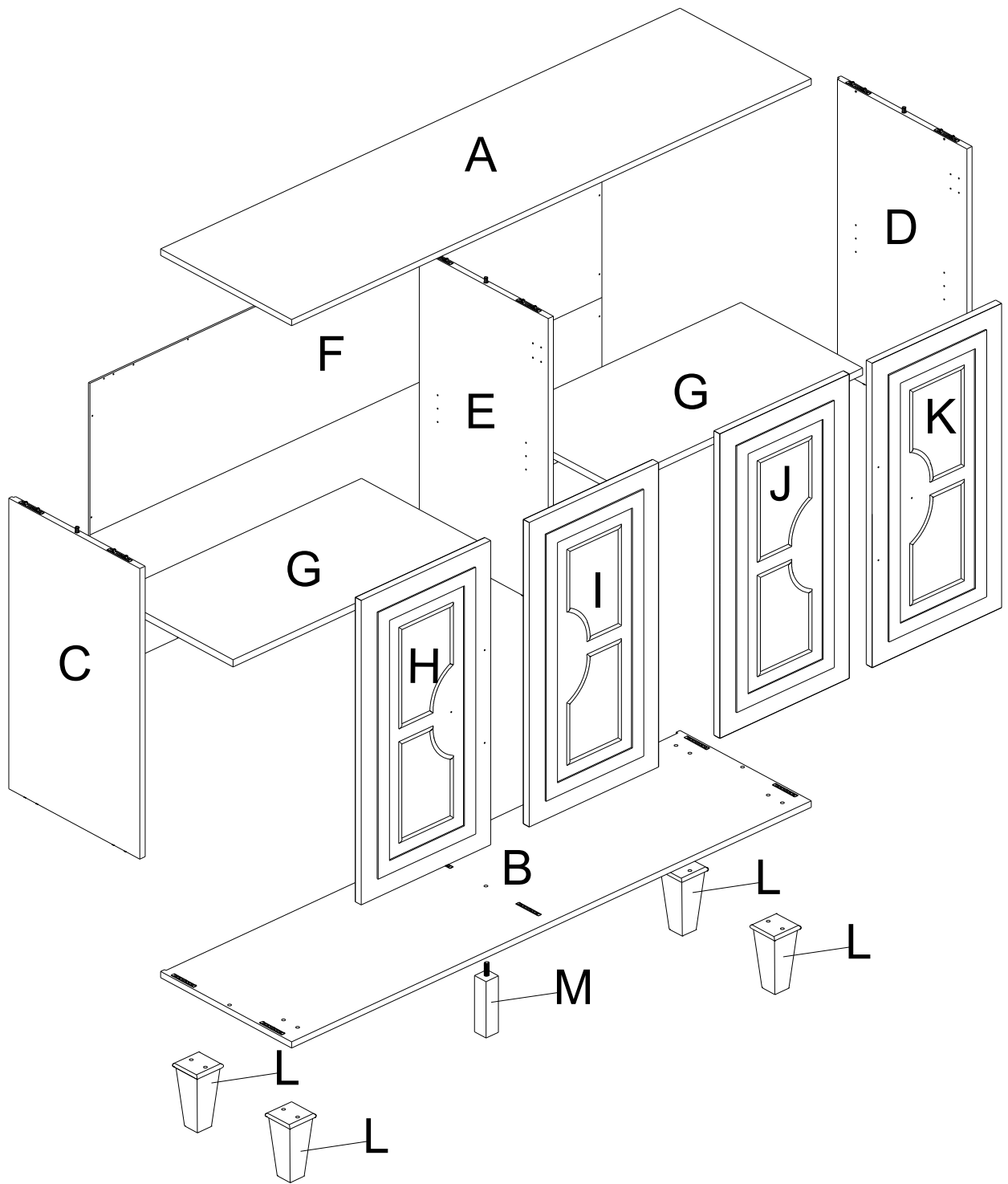

Weight Limitation

100LBS

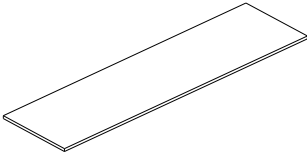
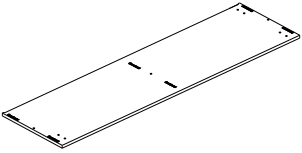

OVERVIEW

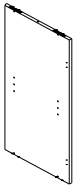
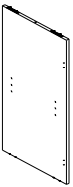
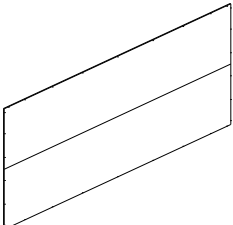
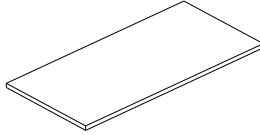
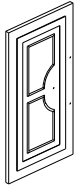
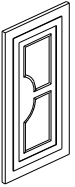
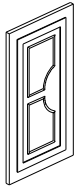
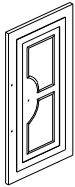
HARDWARE LIST

<p>A</p> 	<p>B</p> 	<p>C</p> 	<p>D</p> 
<p>1 PC</p>	<p>1 PC</p>	<p>1 PC</p>	<p>1 PC</p>
<p>E</p> 	<p>F</p> 	<p>G</p> 	<p>H</p> 
<p>1 PC</p>	<p>1 PC</p>	<p>2 PCS</p>	<p>1 PC</p>
<p>I</p> 	<p>J</p> 	<p>K</p> 	<p>L</p> 
<p>1 PC</p>	<p>1 PC</p>	<p>1 PC</p>	<p>4 PCS</p>
<p>M</p> 			
<p>1 PCS</p>			

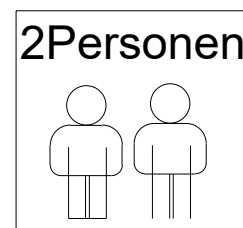

Persons Required For Assembly:

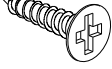
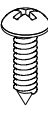

PARTS LIST 1



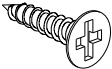





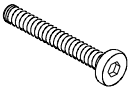
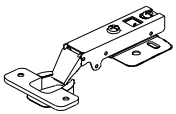
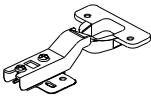

#1	x52	#2	x26
			

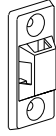
SPARE

#1	x1	#2	x1
			

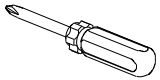
Be sure to inspect all packing material carefully for small parts, that may have come loose inside the carton during shipment.

PARTS LIST 2

#3	x8	#4	x4	#5	x4	#6	x8	#7	x4
									
#8	x4	#9	x4	#10	x2	#11	x1	#12	x1
									
#13	x6	#14	x2						
									

Be sure to inspect all packing material carefully for small parts, that may have come loose inside the carton during shipment.

ASSEMBLY INSTRUCTIONS

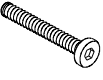
#12	x1	#3	x8
			

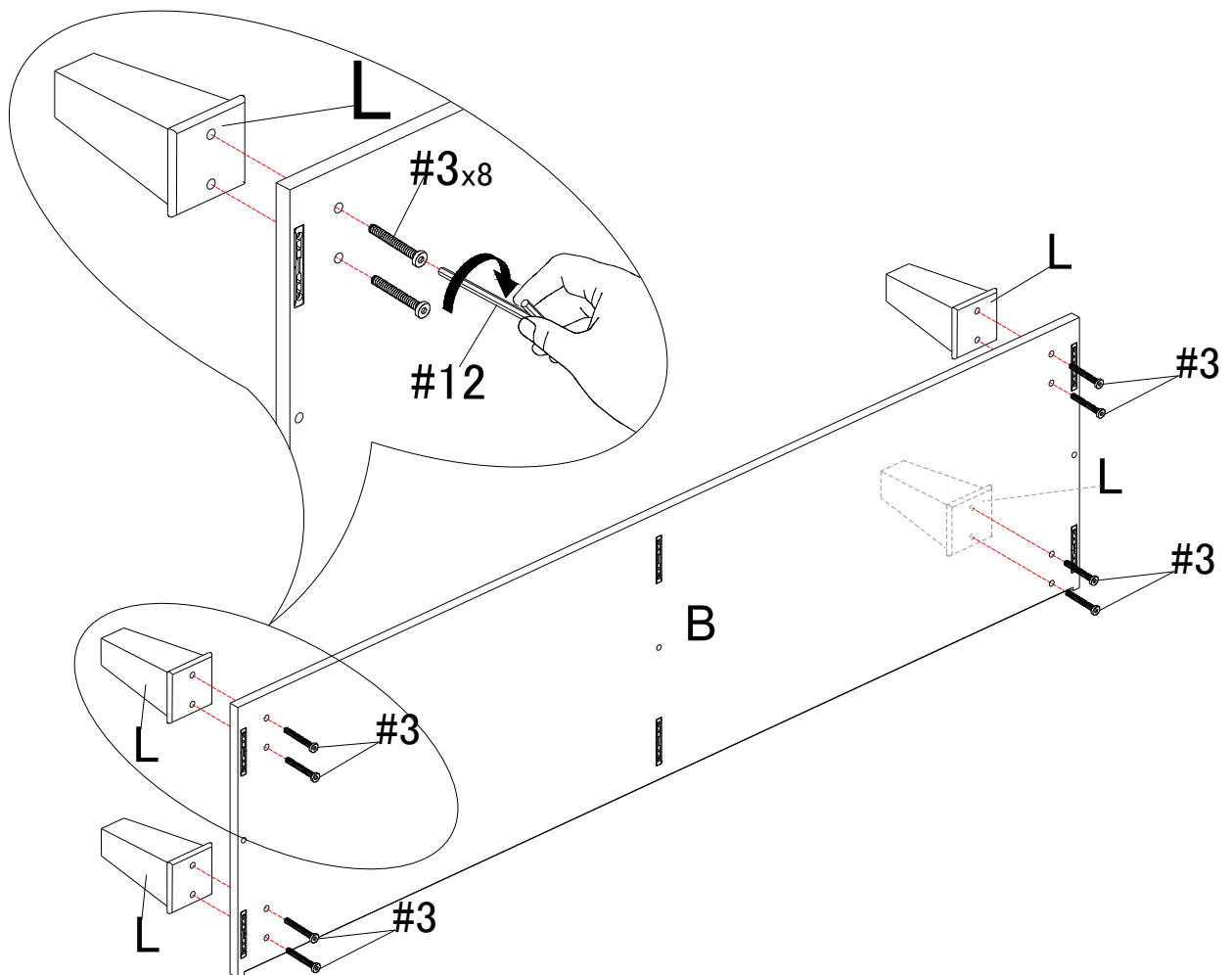

STEP1:

Prepare leg (L)、bottom panel (B) and bolt #3、allen key #12. Use bolt #3 to attach leg (L) to bottom panel (B), make sure all holes aligned and tighten bolt #3 with allen key #12.

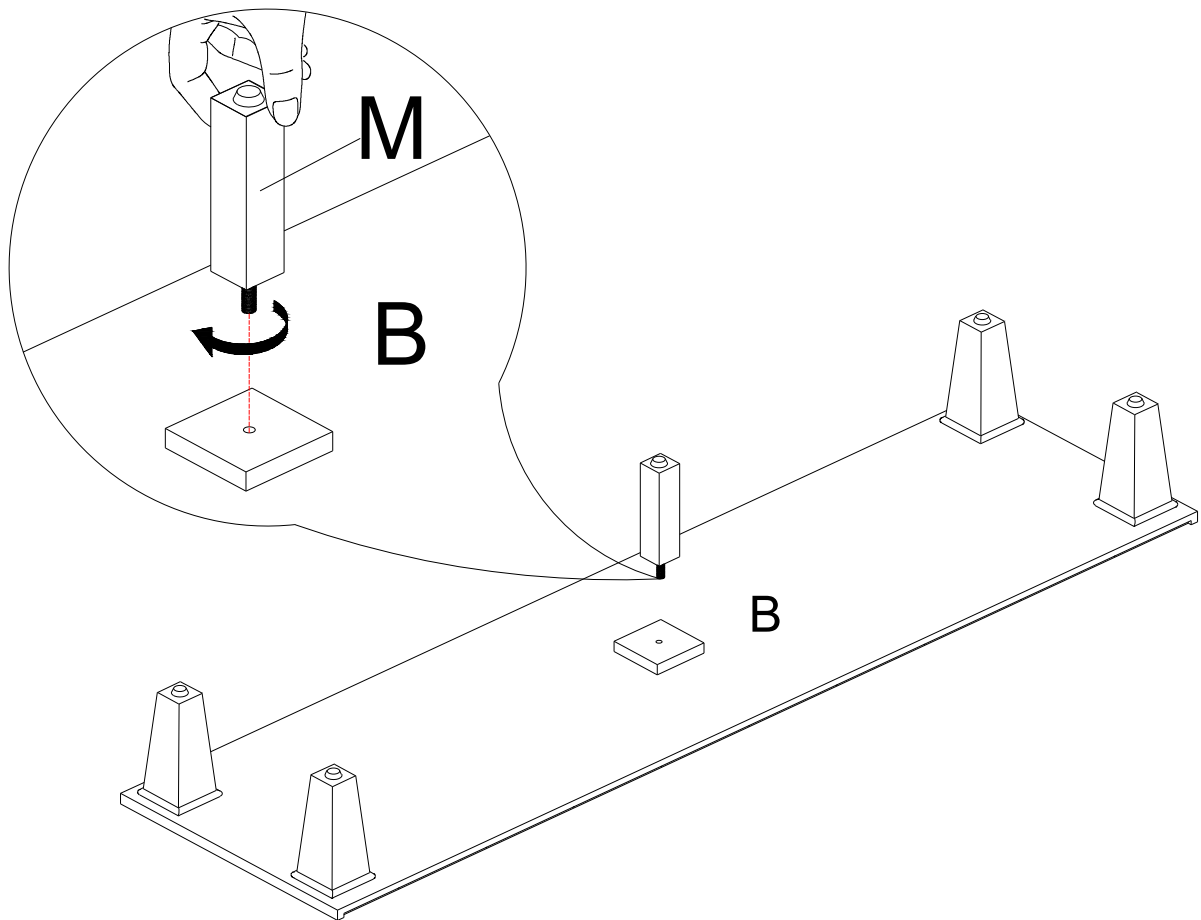

STEP2:

Prepare leg (M) Screw leg (M) into the corresponding hole of bottom panel (B) with hand.

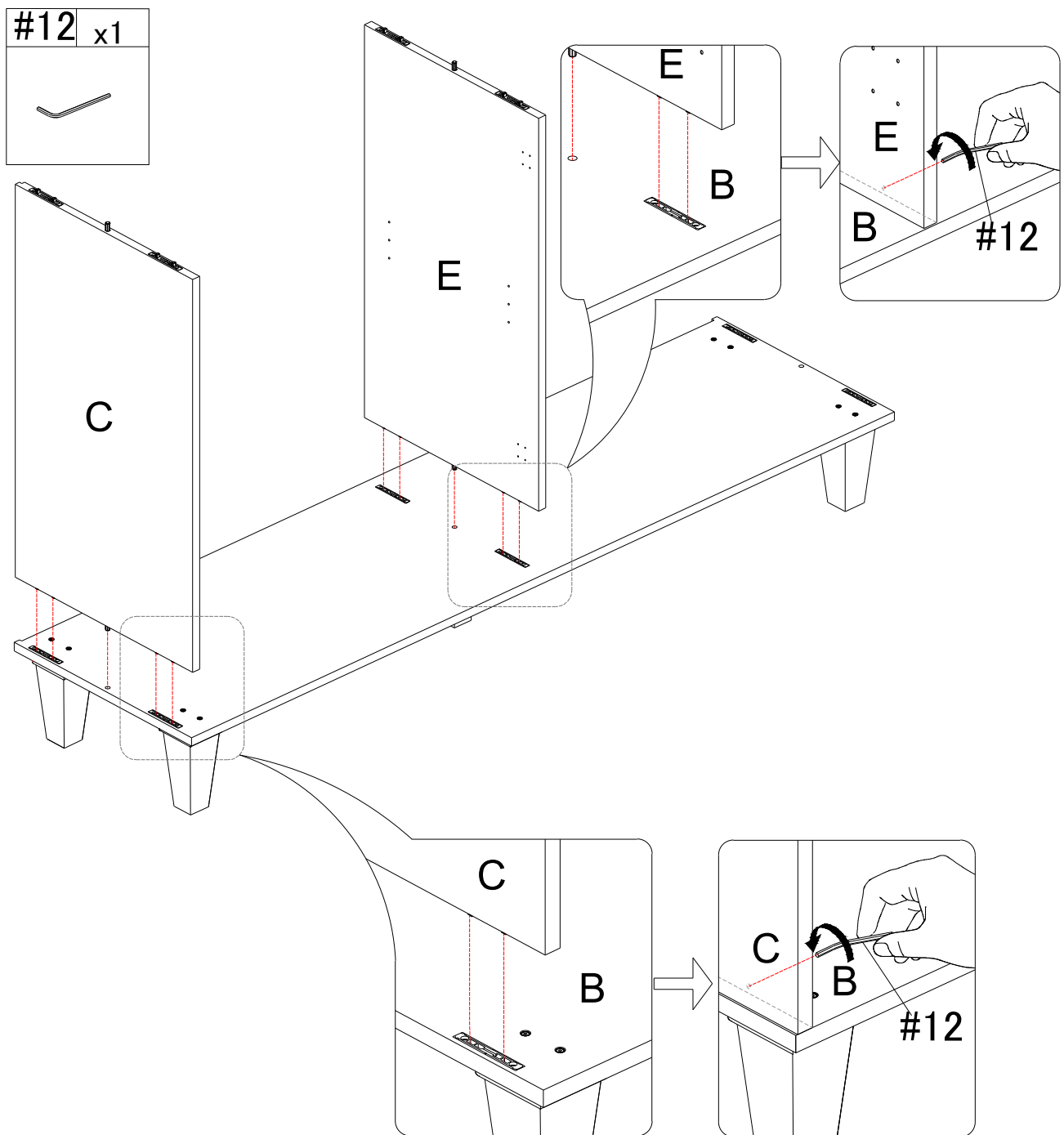

STEP3:

Prepare side panel (C) and middle vertical panel (E).
Insert side panel (C) & middle vertical panel (E) into the
preassembled step 2, use allen key #12 to lock it

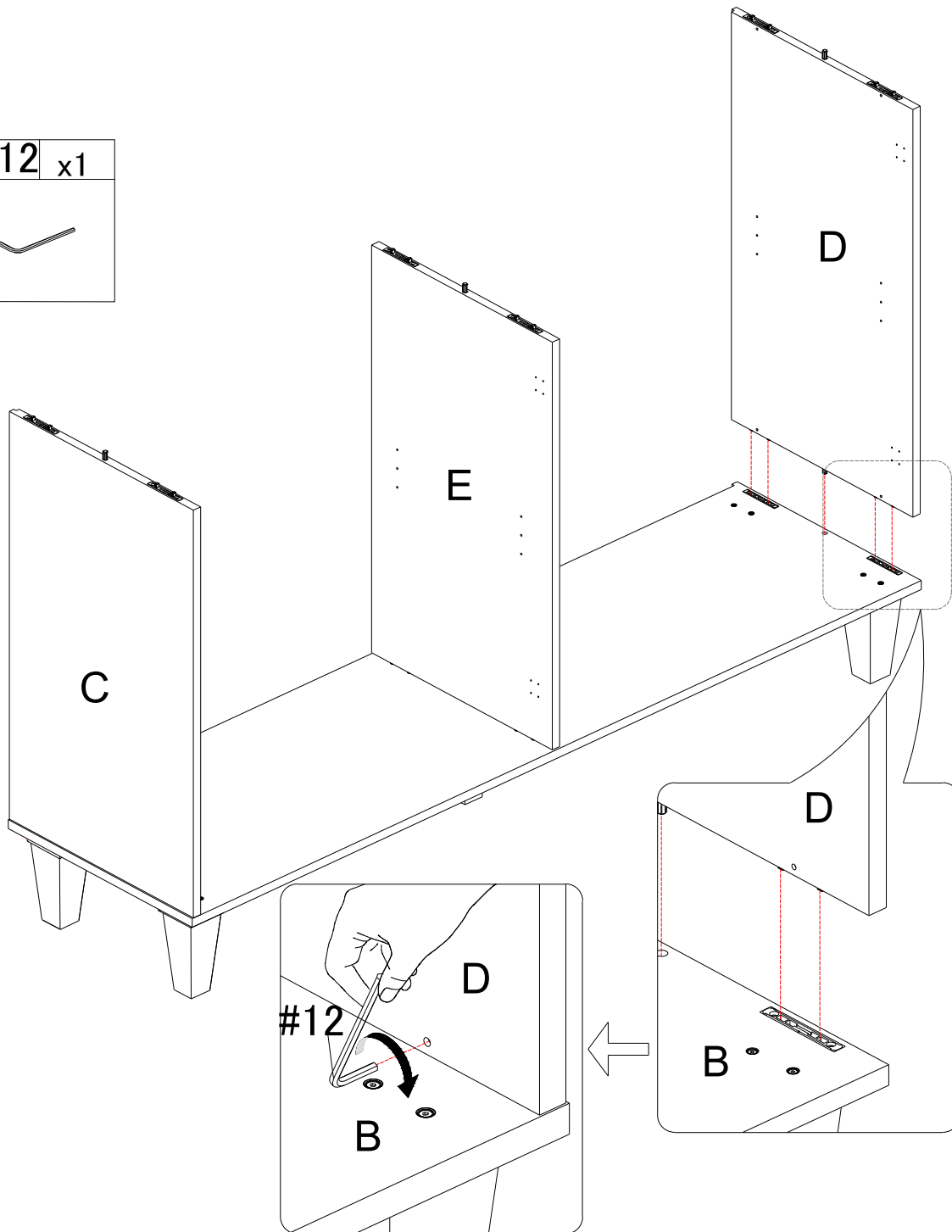
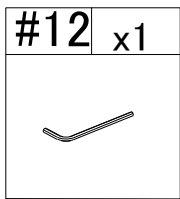

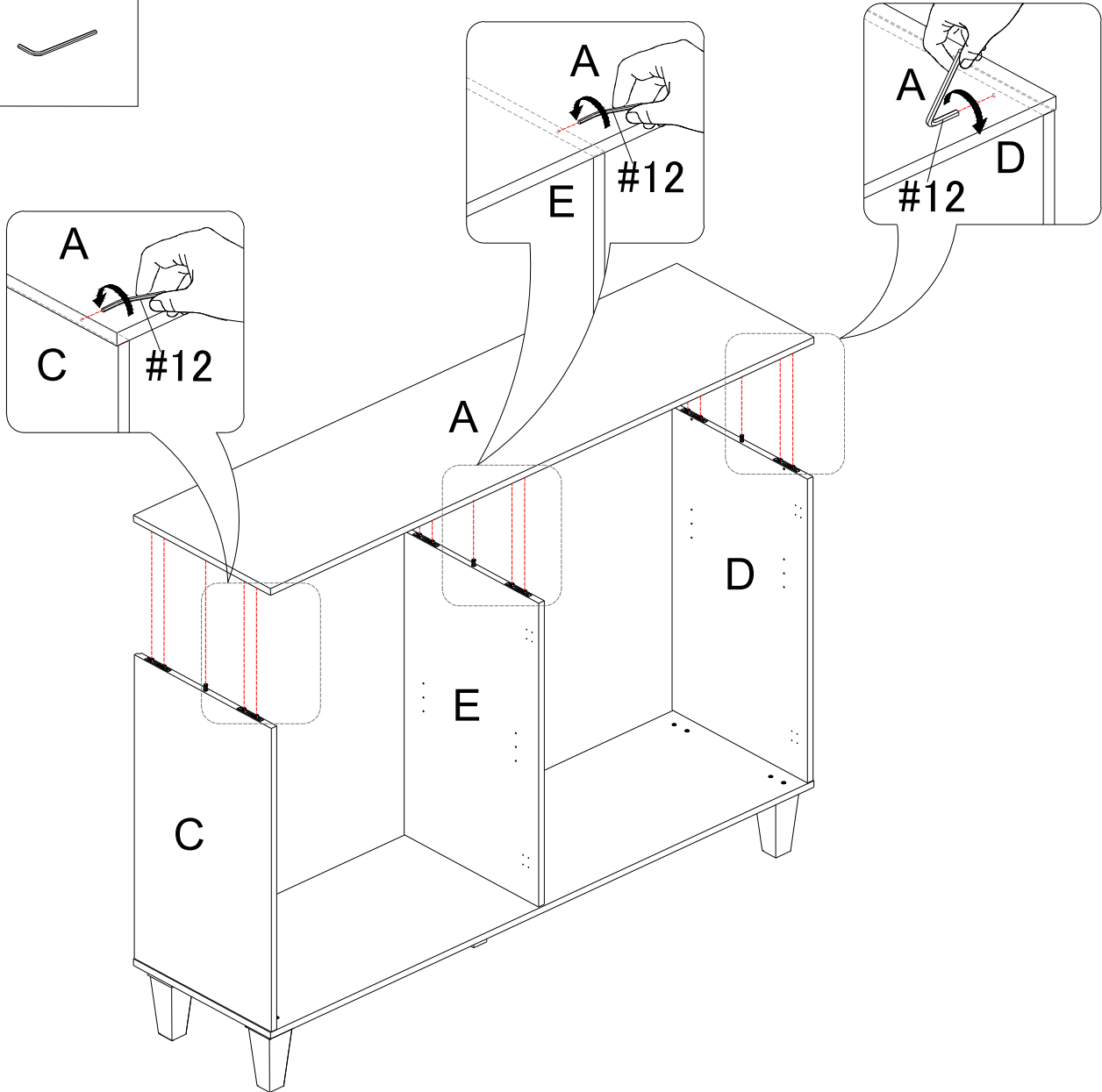
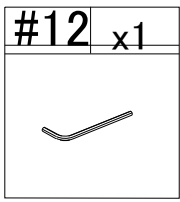

STEP4:

Prepare side panel (D). Insert side panel (D) into the preassembled step3, use allen key #12 to lock it.

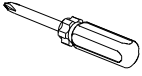

STEP5:

Prepare top panel (A). Insert top panel (A) into the preassembled step 4, use allen key #12 to lock it.

#11	x1	#2	x26
			

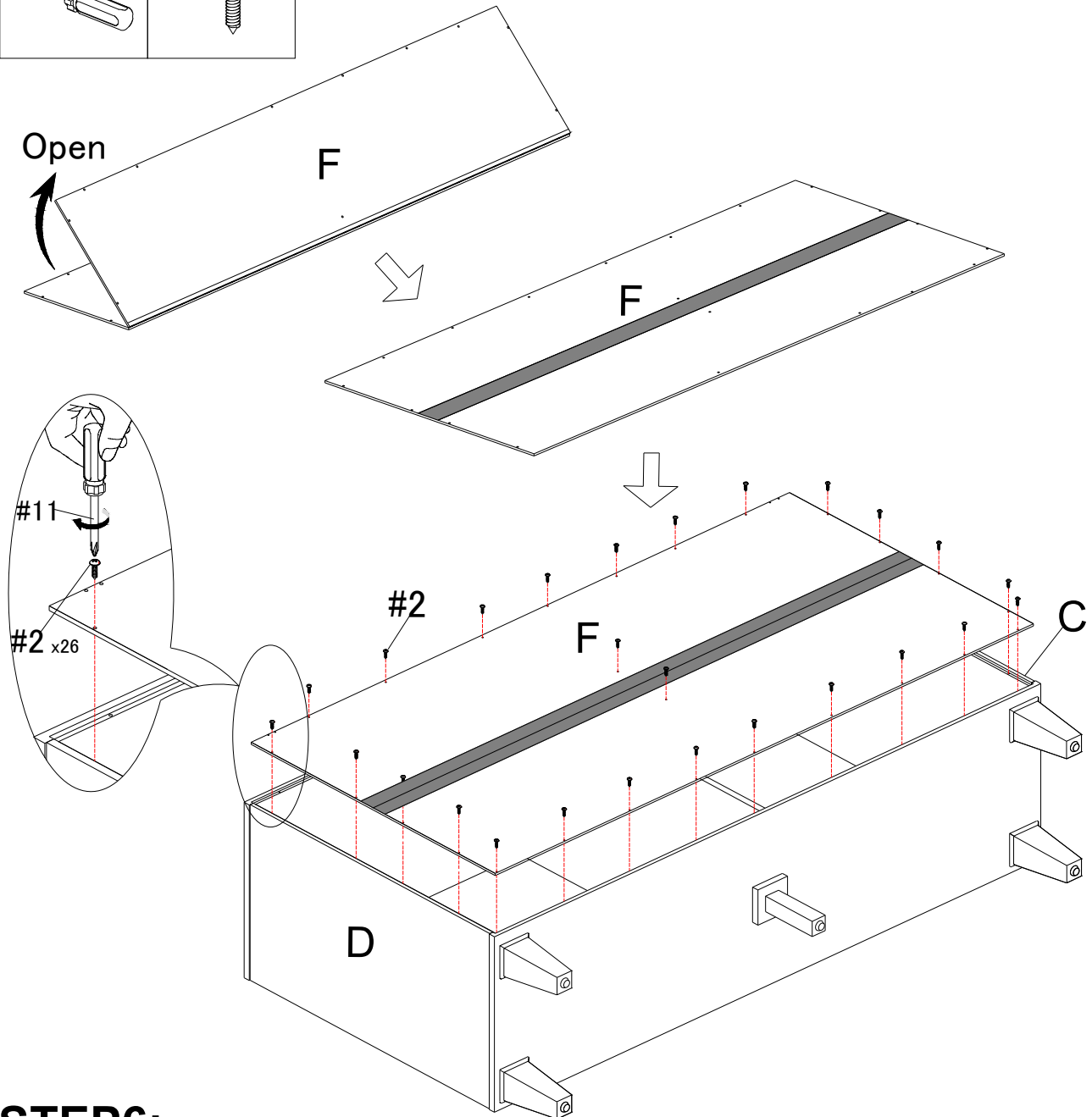

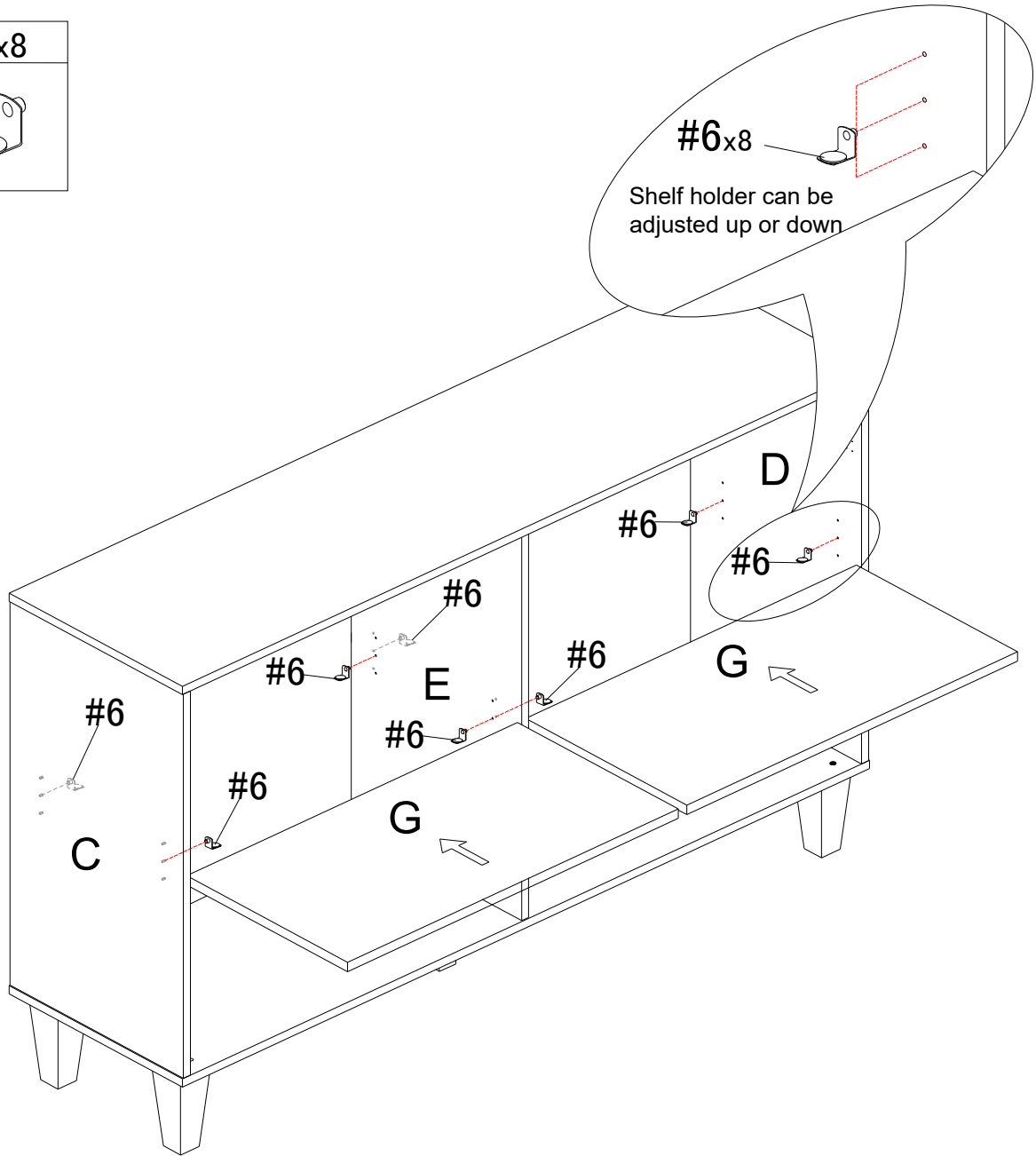
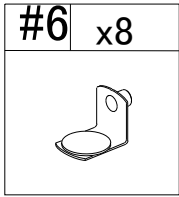

STEP6:

Prepare back panel (F). Open bake panel (F), and then insert back panel (F) into the groove of preassembled step 5, use screw #2 to attach back panel (F) to preassembled step 5.



STEP7:

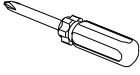

Prepare shelf holder #6 and panel (G). Insert shelf holder #6 into the corresponding hole of panel (C)&(E)&(D), make sure shelf holders #6 are level, and then attach panel (G) to it.

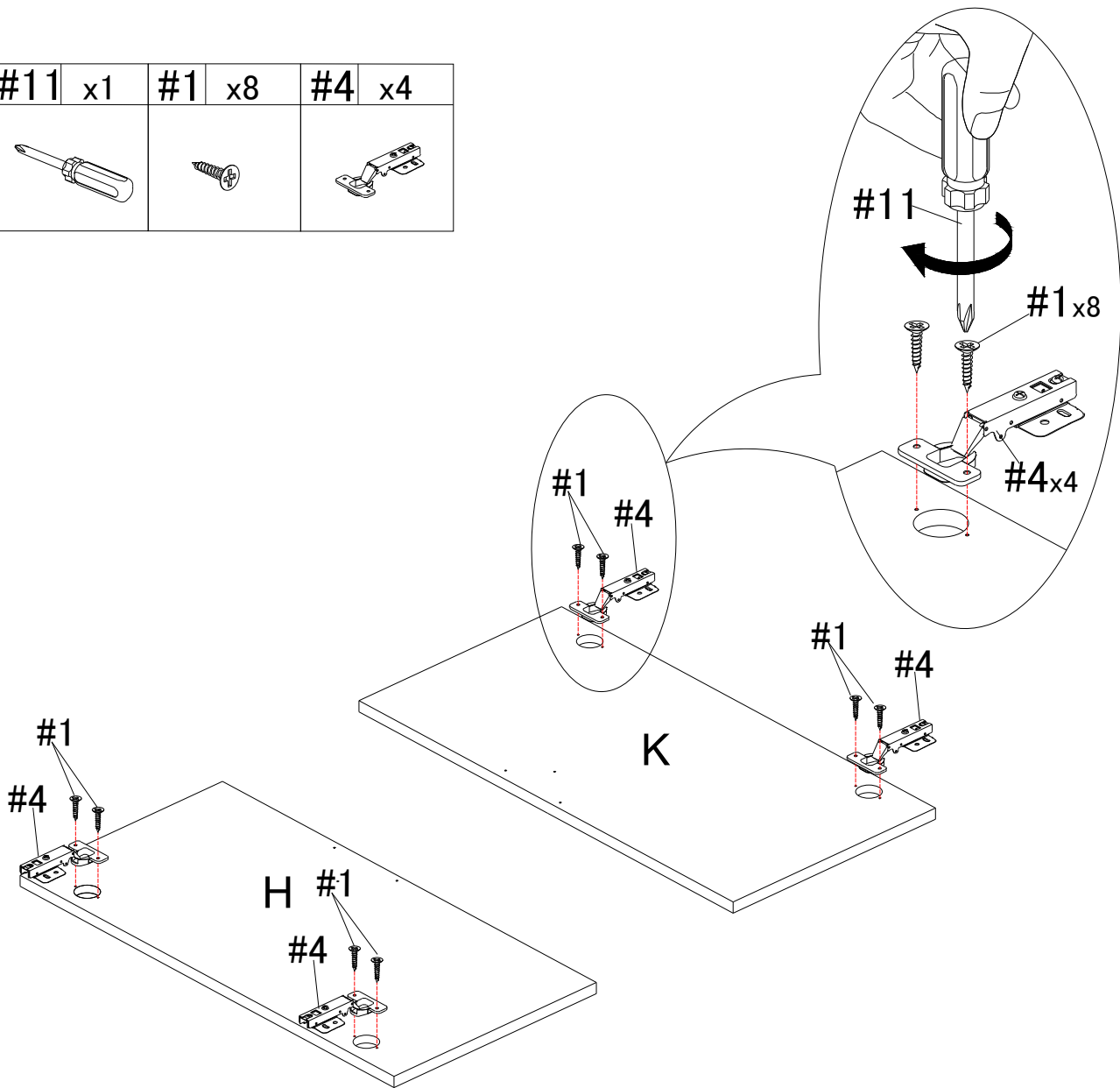
#11	x1	#1	x8	#4	x4
					



STEP8:

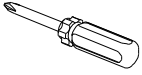

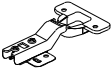
Prepare door (H)&(K)、hinge #4、screw #1 and screwdriver #11. Use screw #1 to attach hinge #4 to doors (H)&(K), make sure all holes aligned and tighten screw #1 with screwdriver #11.

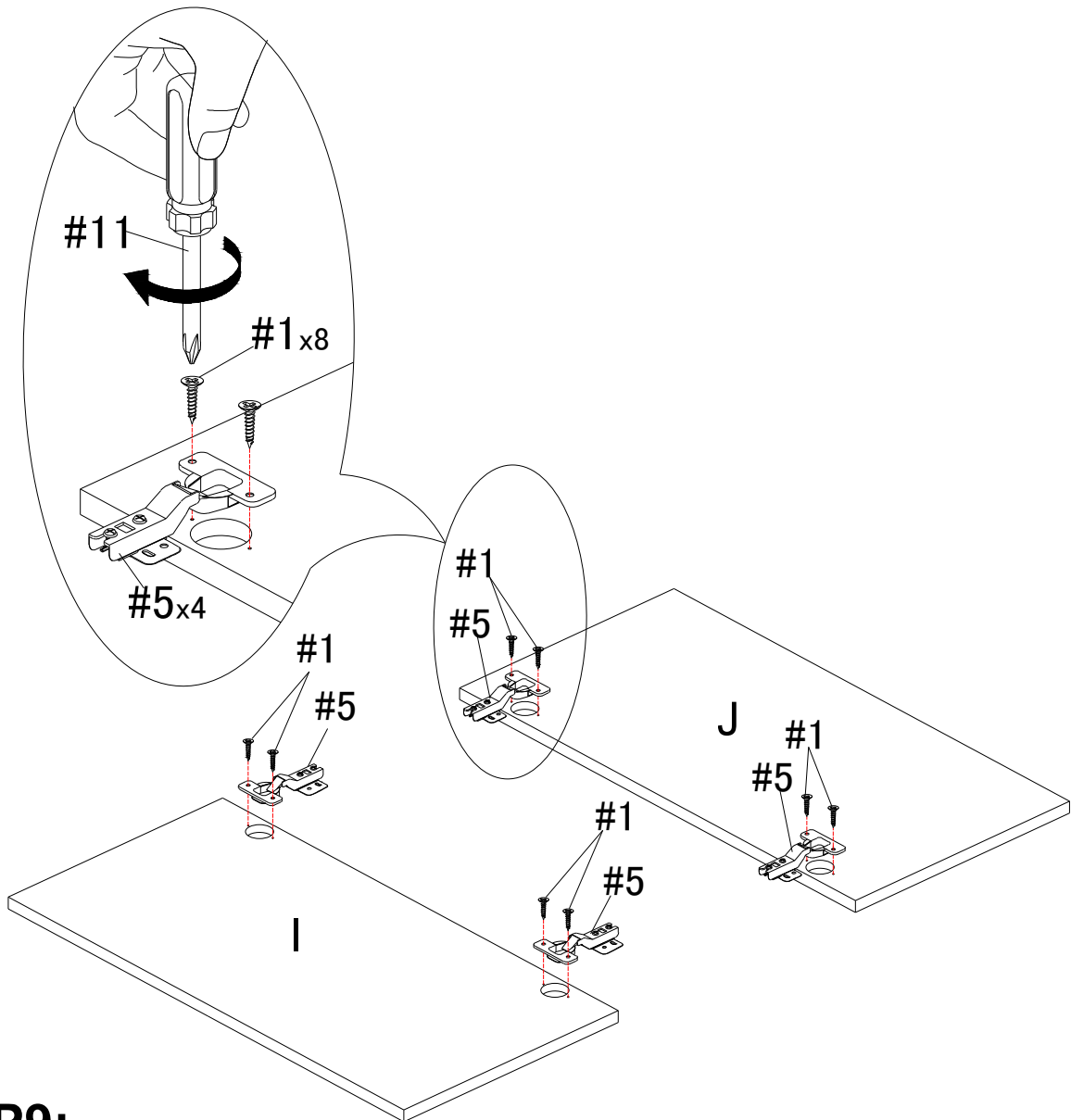
#11	x1	#1	x8	#5	x4
					



STEP9:

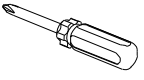

Prepare door (I)&(J)、hinge #5、screw #1 and screwdriver #11. Use screw #1 to attach hinge #5 to doors (I)&(J), make sure all holes aligned and tighten screw #1 with screwdriver #11.

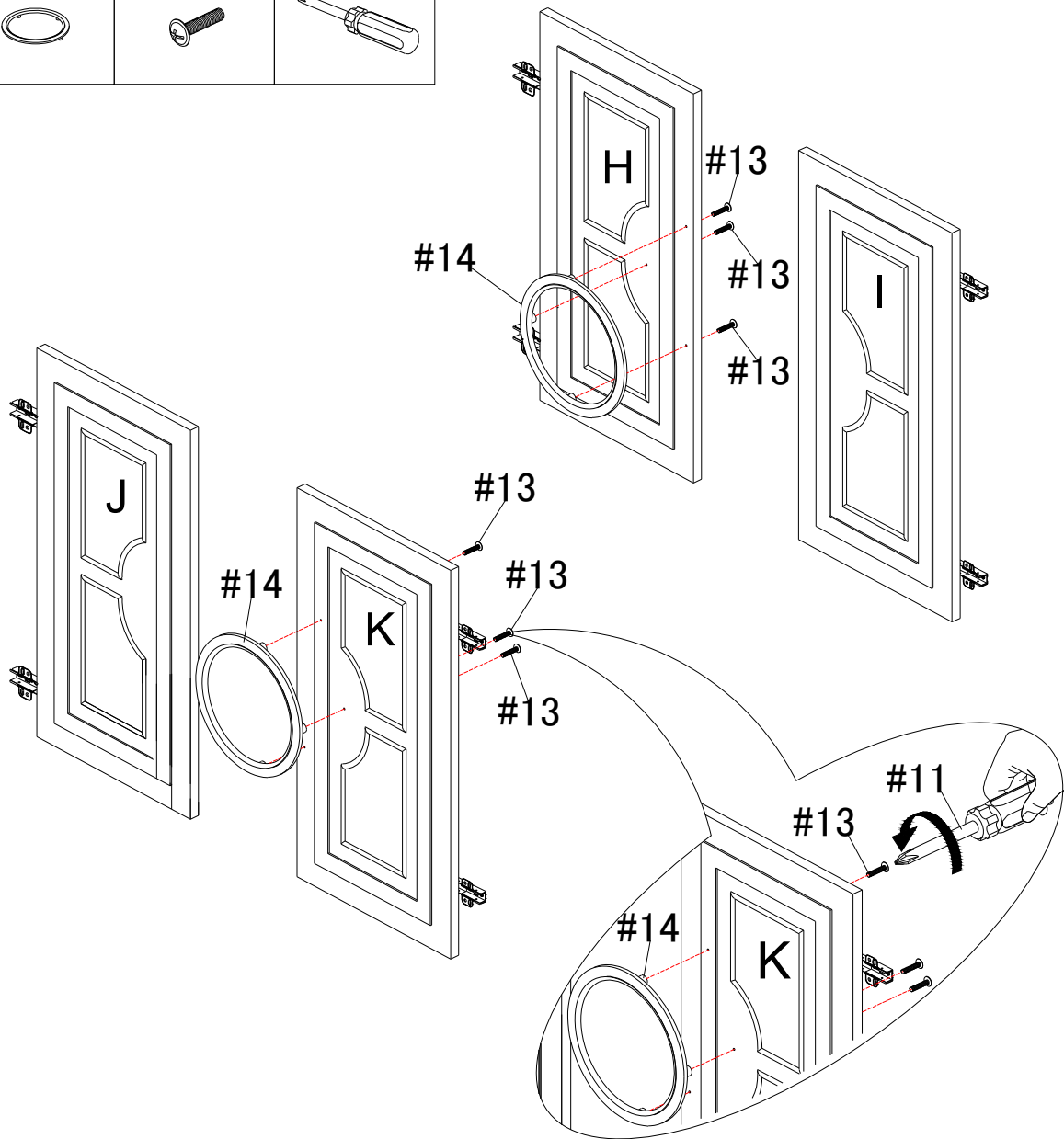
#14	x2	#13	x6	#11	x1
					



STEP10:

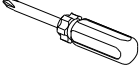

Prepare preassembled doors (H)&(I)&(J)&(K)、handle #14、bolt #13 and screwdriver #11. Use bolt #13 to attach handle #14 to doors (H)&(I)&(J)&(K), make sure all holes aligned and tighten bolt #13 with screwdriver #11.

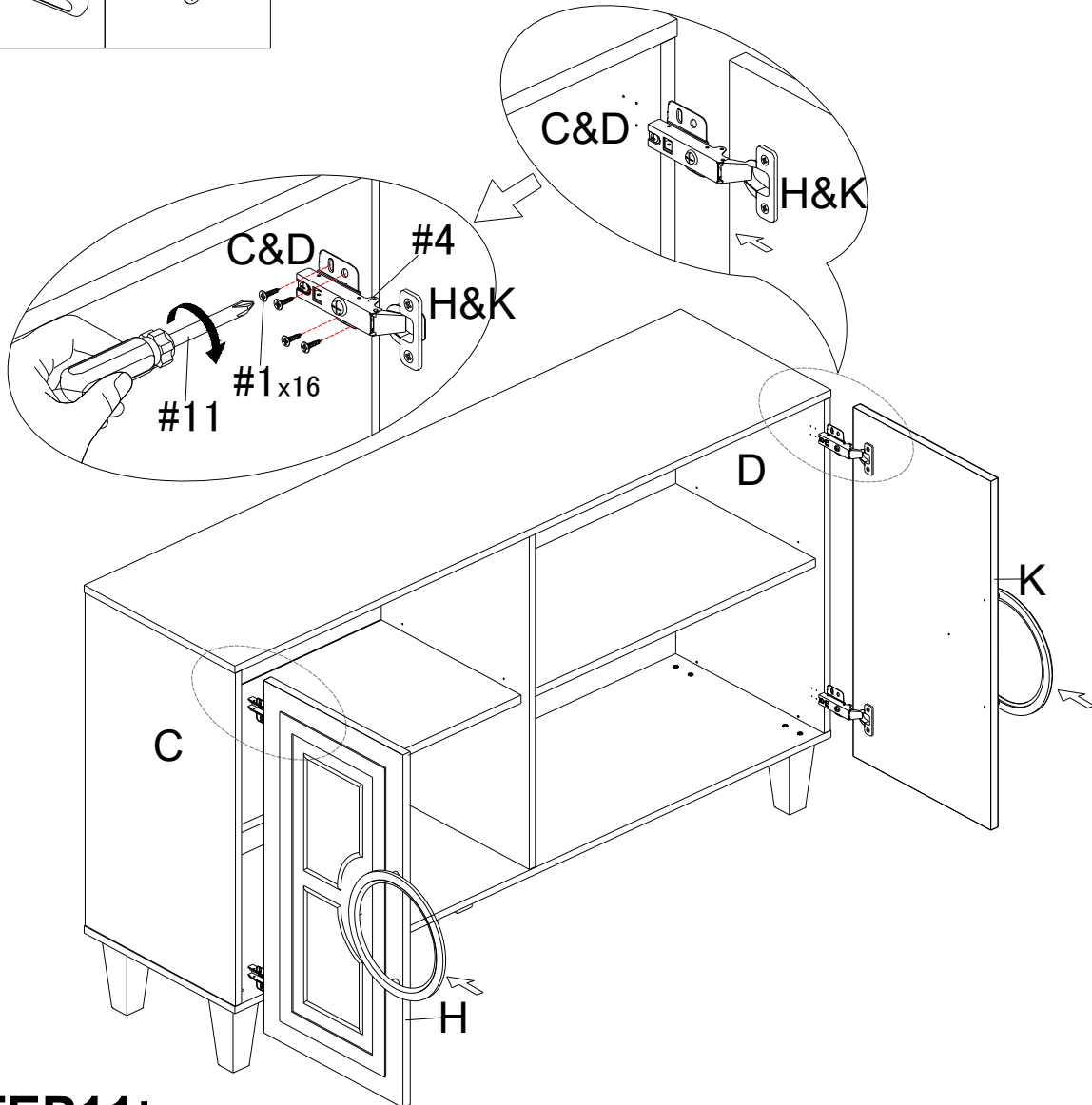
#11	x1	#1	x16
			



STEP11:

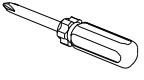

Prepare preassembled doors (H)&(K)、the preassembled step 7 、 screw #1 and screwdriver #11.Aligne the corresponding hole of preassembled doors (H)&(K) with the corresponding hole of side panel (C)&(D), and then use screw #1 to attach hinge #4 to side panel (C)&(D),tighten screw #1 with screwdriver #11.

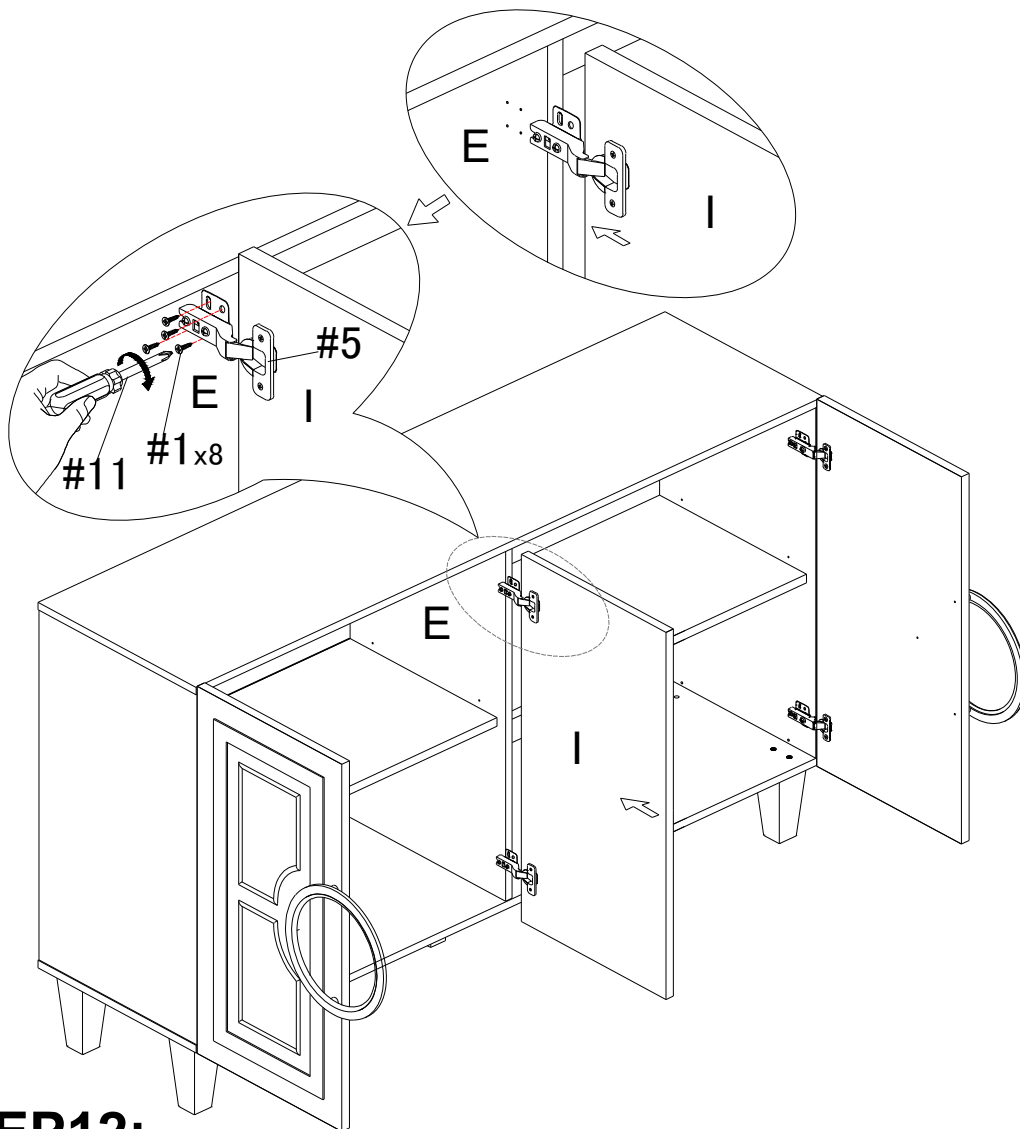
#11	x1	#1	x8
			

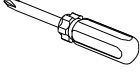

STEP12:

Prepare preassembled doors (I)、the preassembled step 11 、 screw #1 and screwdriver #11. Align the corresponding hole of preassembled door (I) with the corresponding hole of middle vertical panel (E), and then use screw #1 to attach hinge #5 to middle vertical panel (E),tighten screw #1 with screwdriver #11.

#11	x1	#1	x8
			

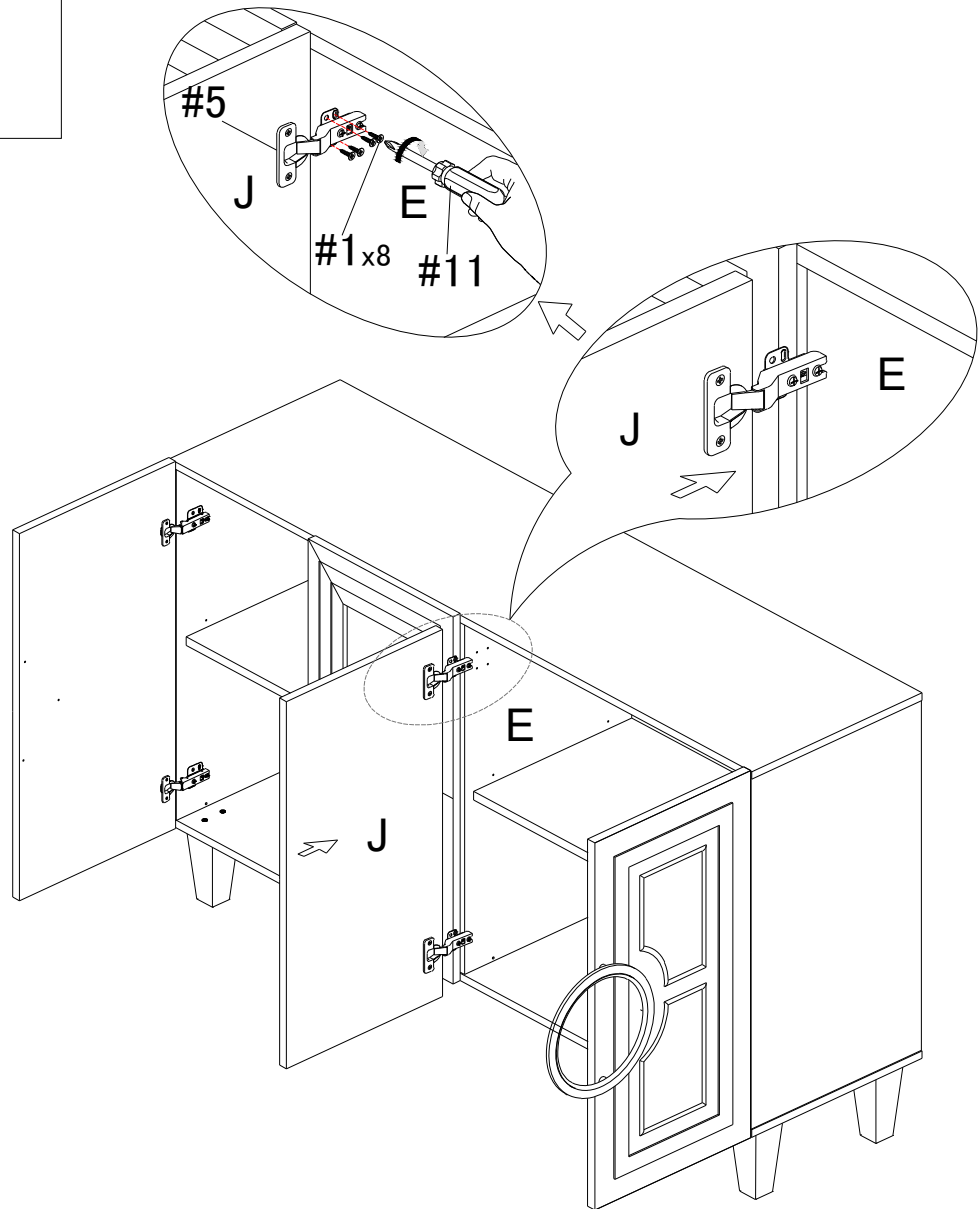

STEP13:

Prepare preassembled doors (J)、the preassembled step 12、screw #1 and screwdriver #11. Align the corresponding hole of preassembled door (J) with the corresponding hole of middle vertical panel (E), and then use screw #1 to attach hinge #5 to middle vertical panel (E), tighten screw #1 with screwdriver #11.

Concealed hinges are three-way adjustable:

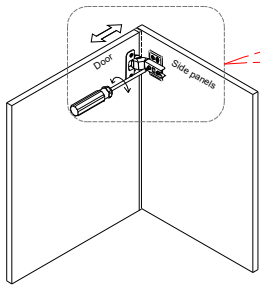

Horizontal
by screw adjustment!

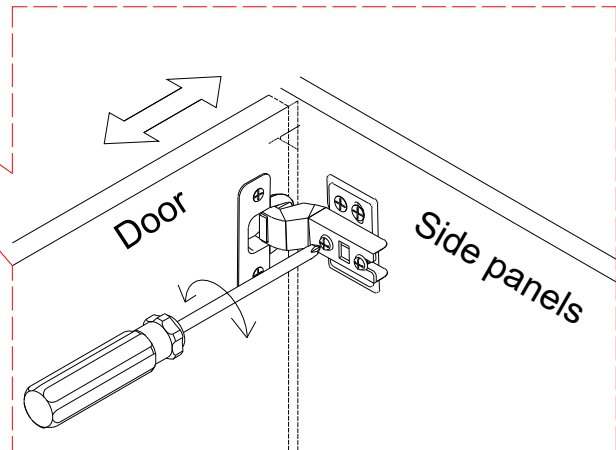

Concealed hinges are three-way adjustable:

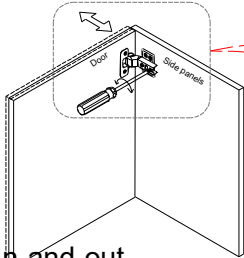

In-and-out
by loosening the hinge arm
mounting screw or via cam
adjustment!

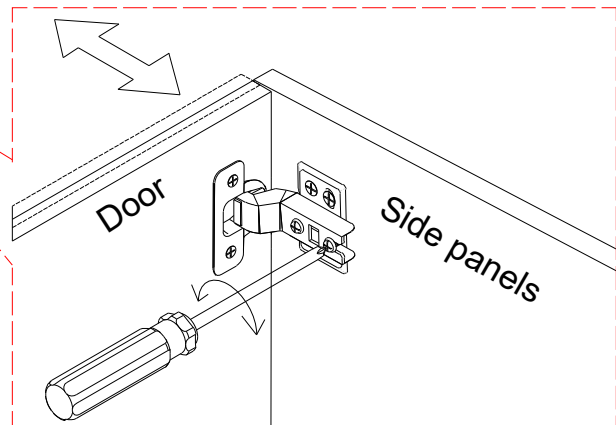

Concealed hinges are three-way adjustable:

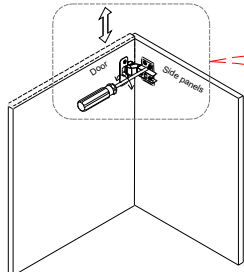

Vertical via slots in
the mounting plate
or via cam adjustment!

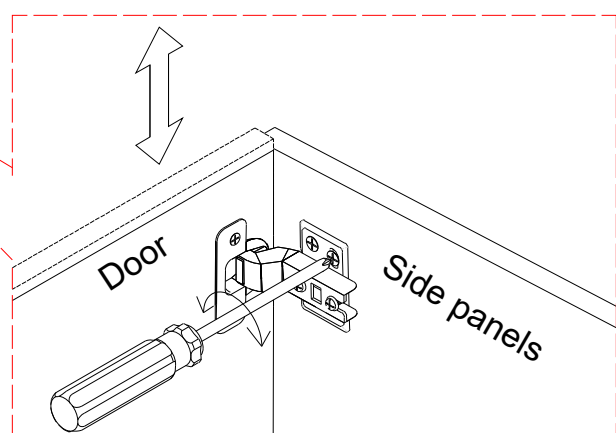

Hinge adjustment method

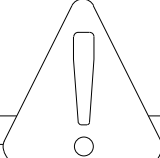

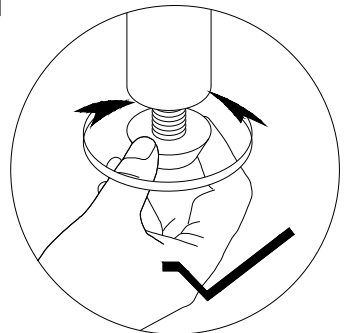
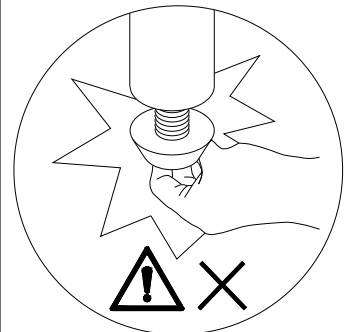
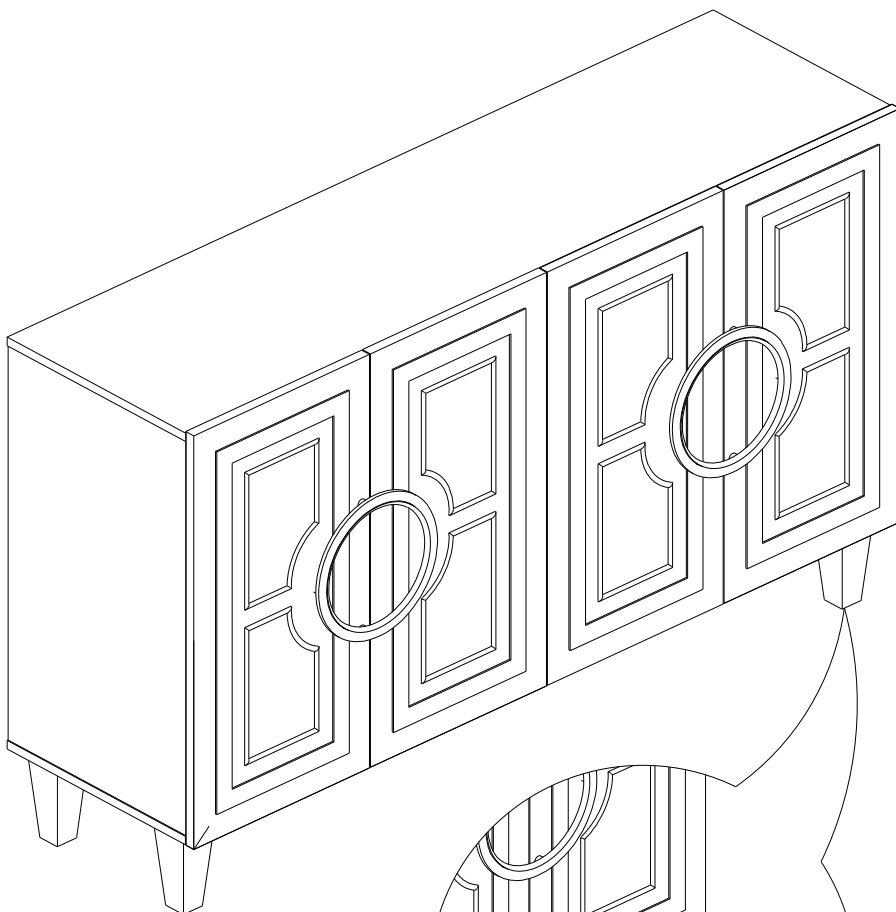

Attention:
After installation, adjust the adjustable leveler to keep the cabinet balanced .

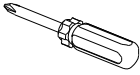

STEP14:

Attention:

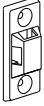
After installation, adjust the adjustable leveler to keep the cabinet balanced .

#11	x1	#1	x4	#7	x2
					

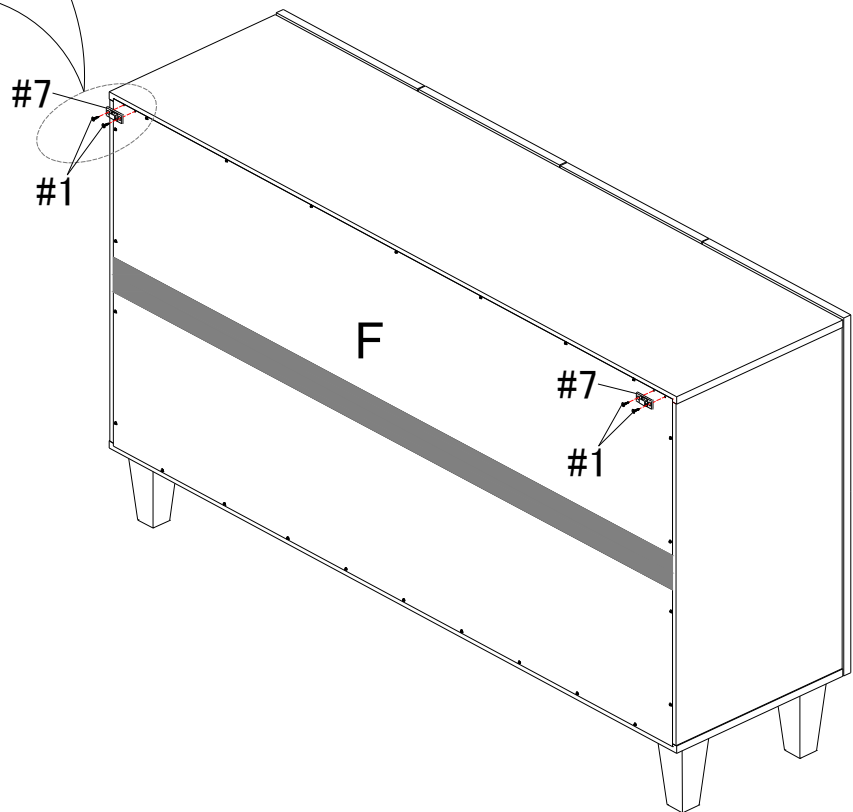
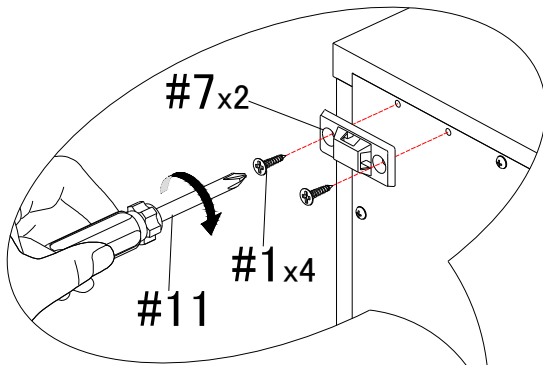

STEP15:

Prepare plastic bracket #7、 the preassembled step 13、 screw #1 and screwdriver #11. Use screw #1 to attach plastic bracket #7 to back panel (F), make sure all holes aligned and tighten screw #1 with screwdriver #11.

NOT PROVIDED

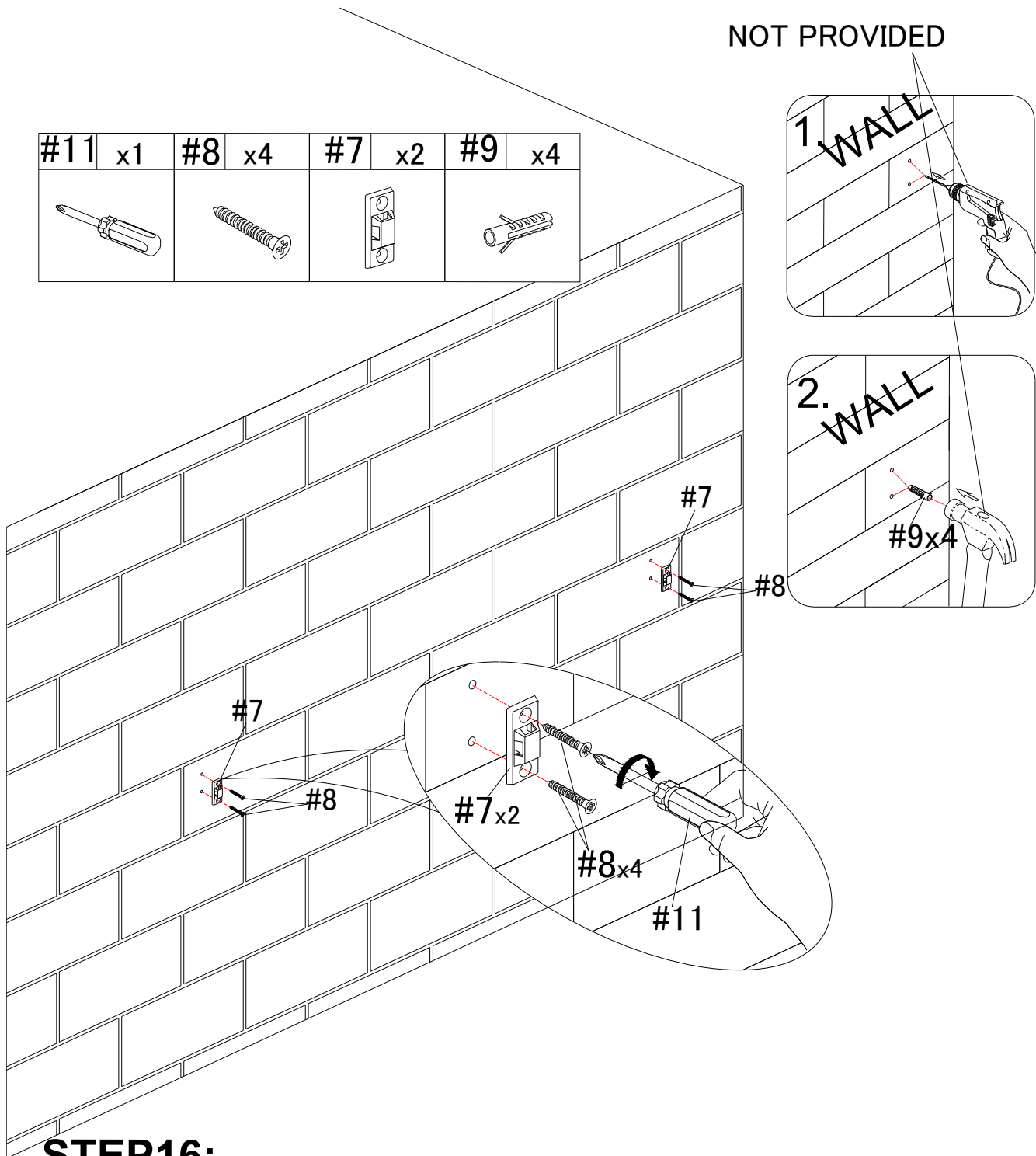

STEP16:

1. Mark the position on the wall, that corresponds to the location of bracket #7 on the back panel F; Drill and insert the expandable screw #9 by hammer.
2. Assemble the bracket #7 to the wall. Align the hole in the bracket #7 with the expandable screw #9, use screw #8 to attach it, tighten screw #8 with screwdriver #11.

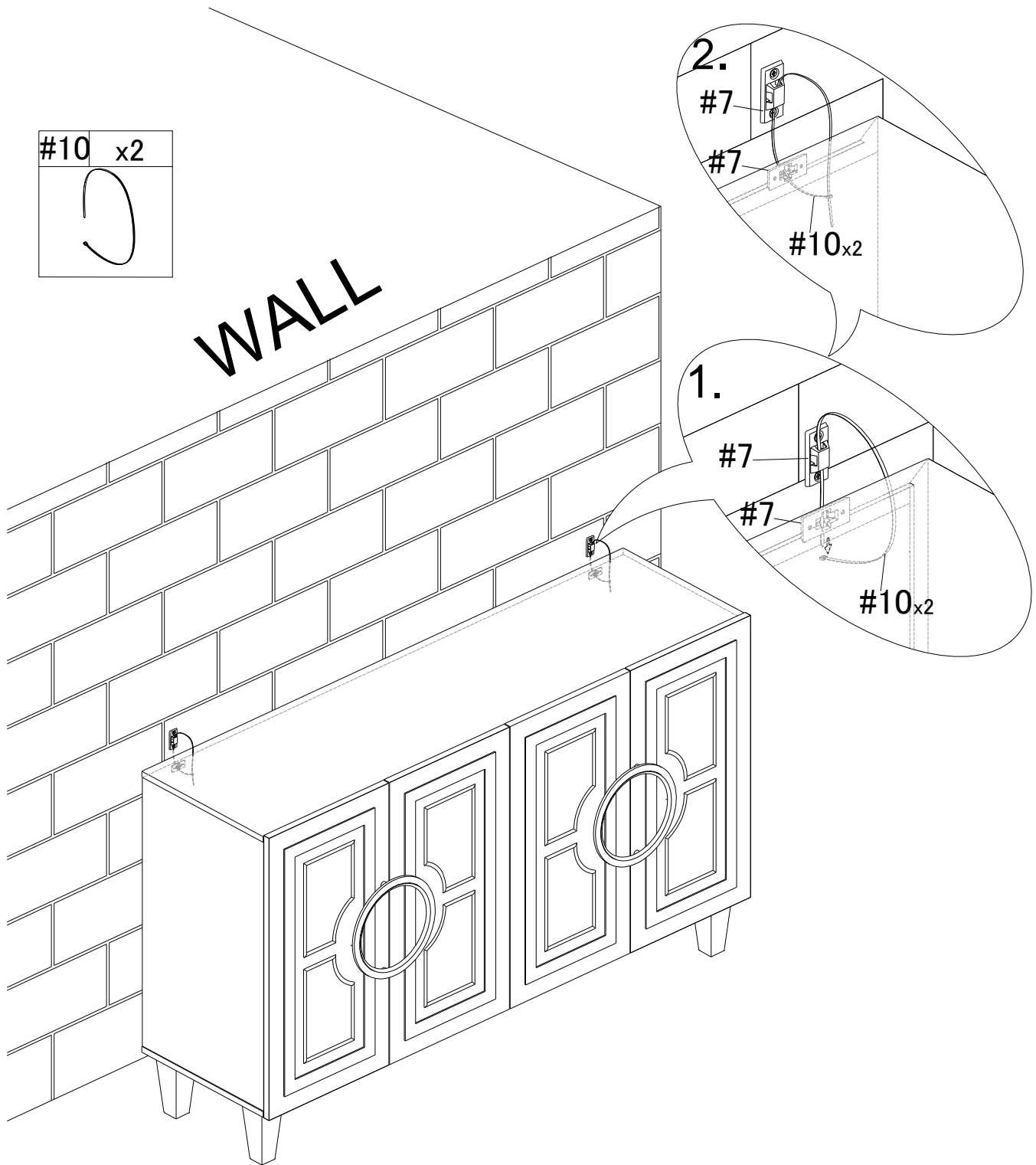

STEP17:

3. Let the plastic belt #10 pass through bracket #7 and pull tightly.

WARRANTY

We strive to offer high-quality products, and we also try our best to satisfy each and every customer that orders from us with product or service as needed. We provide 30 days warranty starting from the time you receive the item. Each customer must provide a record of their order such as the order number, or item receipt for any items that are out of the warranty period you may also still receive replacement parts by purchasing them with our company if they are available.