

ASSEMBLY INSTRUCTIONS



Fine Furniture for every stage of life

FLOOR LAMP

Assembly Instructions













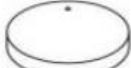

ASSEMBLY TIPS:

1. Remove hardware from box and sort by size.
2. Please check to see that all hardware and parts are present prior to start of assembly.
3. Please follow attached instructions in the same sequence as numbered to assure fast & easy assembly.

Warning!

- 
1. Don't attempt to repair or modify parts that are broken or defective. Please contact the store immediately.
 2. This product is for home use only and not intended for commercial establishments.

PARTS IDENTIFICATION

NO	DESCRIPTION	FIGURE	Q,TY	NO	DESCRIPTION	FIGURE	Q,TY
A	BOTTOM POLE		1 PC				
B	MIDDLE POLE		1 PC	F	PLATE		1 PC
C	TOP POLE		1 PC	G	TOOTH TUBE		1 PC
D	ARM		1 PC	H	WASHER		1 PC
E	BASE		1 PC	I	WASHER		1 PC
F	SHADE		1 PC	J	NUT		1 PC
G	LIGHT BULB		1 PC	K	WRENCH		1 PC
				L	SCREW		1 PC
				M	RUNG		1 PC

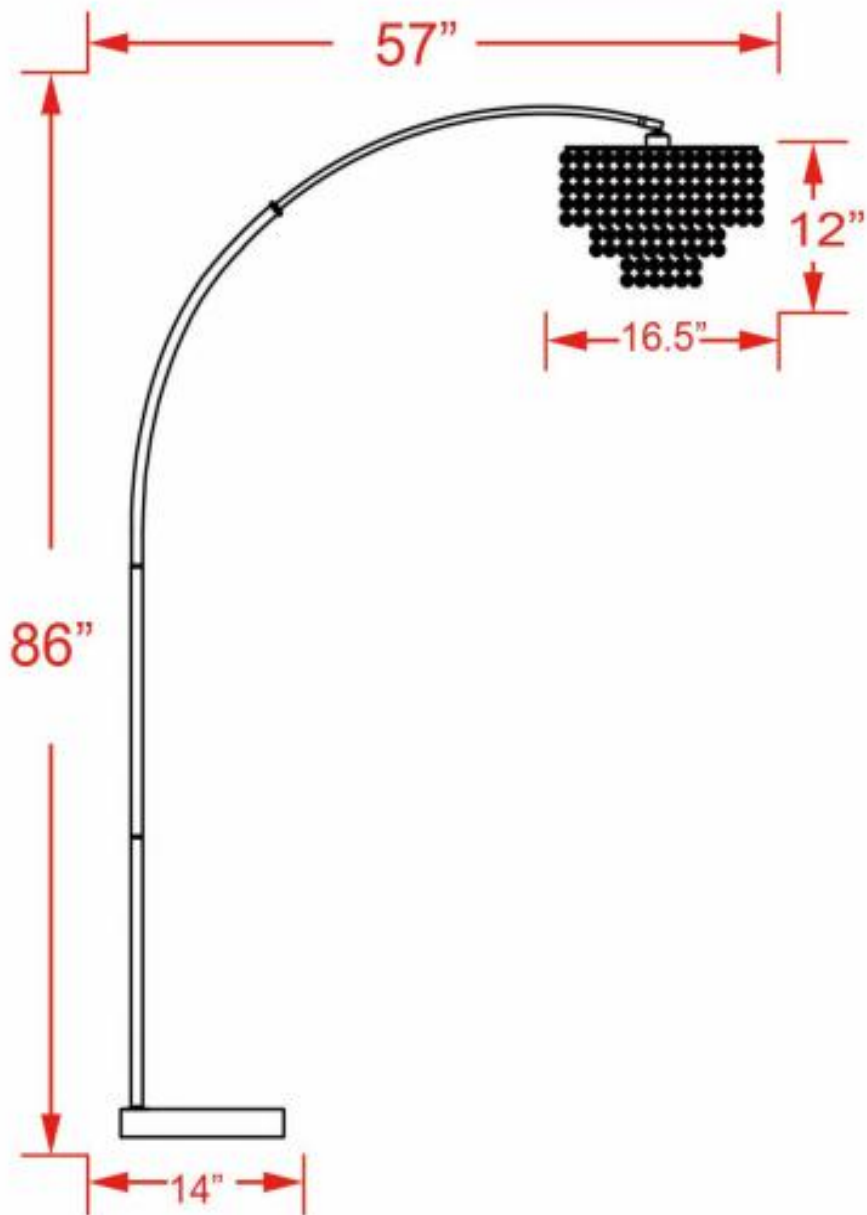

Note : Dimension tolerance $\pm 5\%$