





ASSEMBLY INSTRUCTION RECLINING CHAIR

NOTE: Do not use power tools for assembly. Power tools increase the risk of over tightening which lead to splitting or cracking the wood.

PARTS LIST

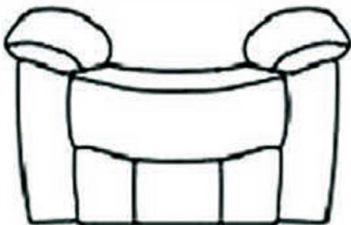
NO.	DRAWING	QTY	DESCRIPTION
A		1	BACK REST
B		1	LSF EAR
C		1	RSF EAR
D		1	SEAT

Please follow the drawings below to assemble the item.

Step 1. Align the female brackets at the back rest onto the male brackets at the seat, insert and push to the end, make sure the brackets are secured in position.

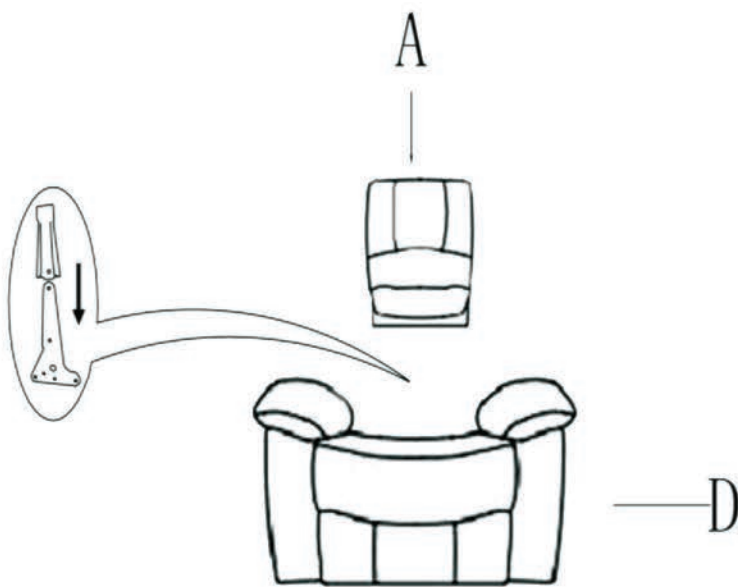

Step 2. Insert the LSF ear and RSF ear to the back rest and make sure it is secured in position.

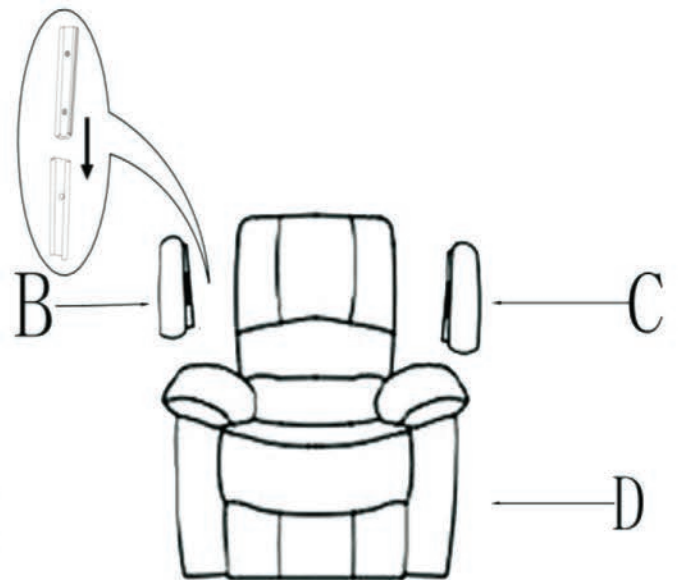

Step 3. Completed.



CARE INSTRUCTION FOR FABRIC FURNITURE:





- Avoid exposing furniture directly to sunlight or heating and air conditioning outlets. Exposure to sunlight or heating and air conditioning outlets will fade/damage fabric.
- Wipe gently with a damp soft cloth to remove dust, dirt and any grime buildup.

ASSEMBLY INSTRUCTION

DOUBLE RECLINING LOVE SEAT

NOTE: Do not use power tools for assembly. Power tools increase the risk of over tightening which lead to splitting or cracking the wood.

PARTS LIST

NO.	DRAWING	QTY	DESCRIPTION
A		1	LSF BACK REST
B		1	RSF BACK REST
C		1	LSF EAR
D		1	RSF EAR
E		1	SEAT

Please follow the drawings below to assemble the item.

Step 1. Align the female brackets at the back rest onto the male brackets at the seat, insert and push to the end, make sure the brackets are secured in position.

Step 2. Insert the LSF ear and RSF ear to the back rest and make sure it is secured in position.

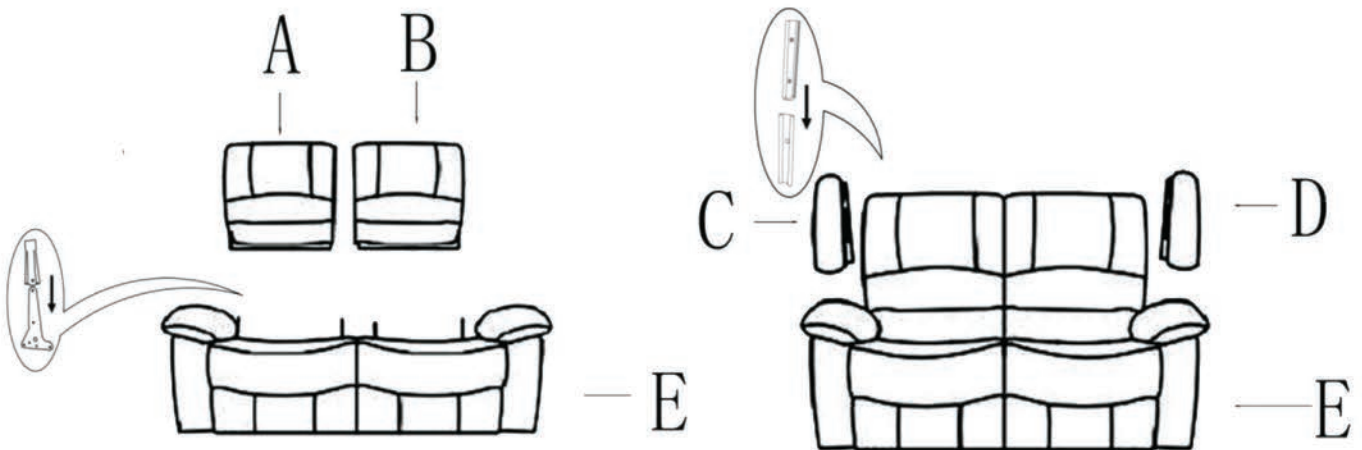

Step 3. Completed.

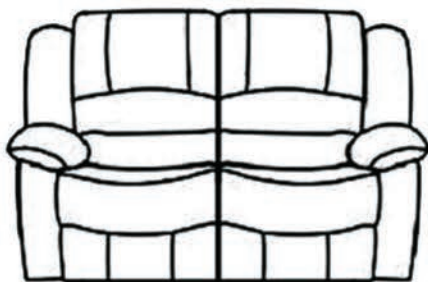







CARE INSTRUCTION FOR FABRIC FURNITURE:

- Avoid exposing furniture directly to sunlight or heating and air conditioning outlets. Exposure to sunlight or heating and air conditioning outlets will fade/damage fabric.
- Wipe gently with a damp soft cloth to remove dust, dirt and any grime buildup.

ASSEMBLY INSTRUCTION DOUBLE RECLINING SOFA

OTE:Do not use power tools for assembly.Power tools increase the risk of over tightening which lead to splitting or cracking the wood.

PARTS LIST

NO.	DRAWING	QTY	DESCRIPTION
A		1	LSF BACK REST
B		1	MIDDLE BACK REST
C		1	RSF BACK REST
D		1	LSF EAR
E		1	RSF EAR
F		1	SEAT

Please follow the drawings below to assemble the item.

Step 1. Align the female brackets at the back rest onto the male brackets at the seat, insert and push to the end, make sure the brackets are secured in position.

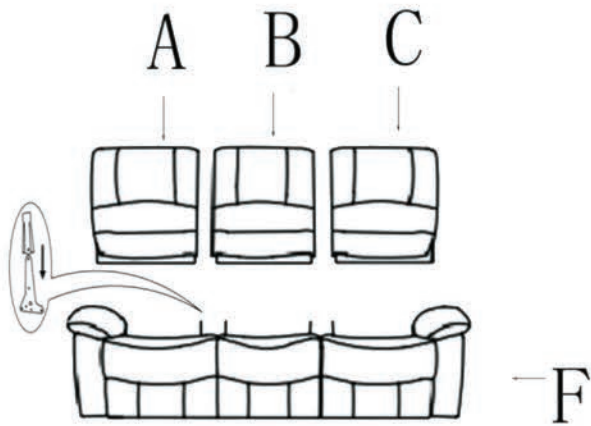

Step 2. Insert the LSF ear and RSF ear to the back rest and make sure it is secured in position.

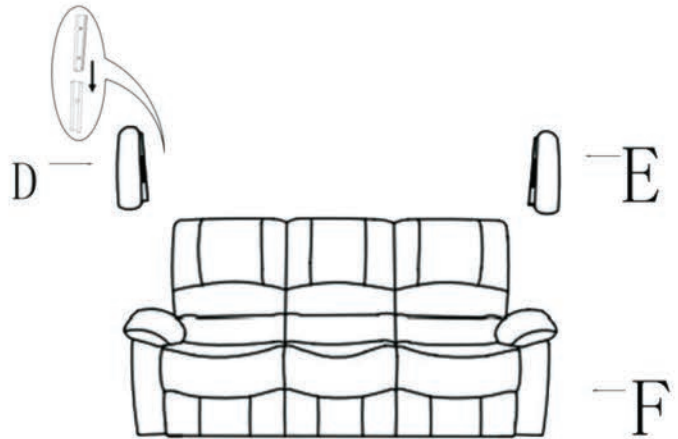

Step 3. Completed.

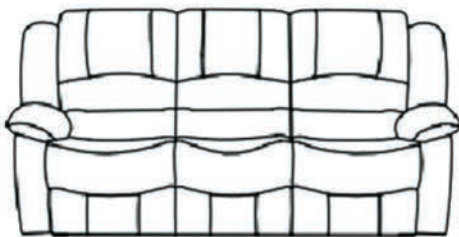

CARE INSTRUCTION FOR FABRIC FUNITURE:

- Avoid exposing furniture directly to sunlight or heating and air conditioning outlets. Exposure to sunlight or heating and air conditioning outlets will fade/damage fabric.
- Wipe gently with a damp soft cloth to remove dust, dirt and any grime buildup.