











Part List

PART	DRAWING	DESCRIPTION	QTY	PART	DRAWING	DESCRIPTION	QTY
A		Stool Seat	2	F		Bolt	8
B		Stool Post	2	G		Bolt	32
C		Stool Leg	8	H		Lock Washer	8
D		Lower Stretcher	2	I		Flat Washer	8
E		Foot Rest	2	J		Allen Key (M4)	1
				K		Leveler (pre-assembled)	8

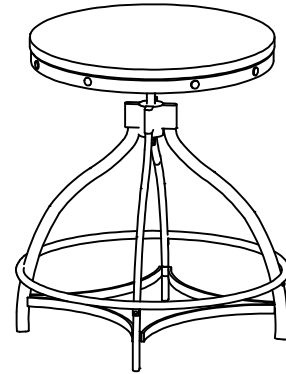

NOTED: If needed, only part F-K are available for replacement.

IMPORTANT: Do not fully tighten the bolts. Loose bolts will facilitate assembly in the following steps.

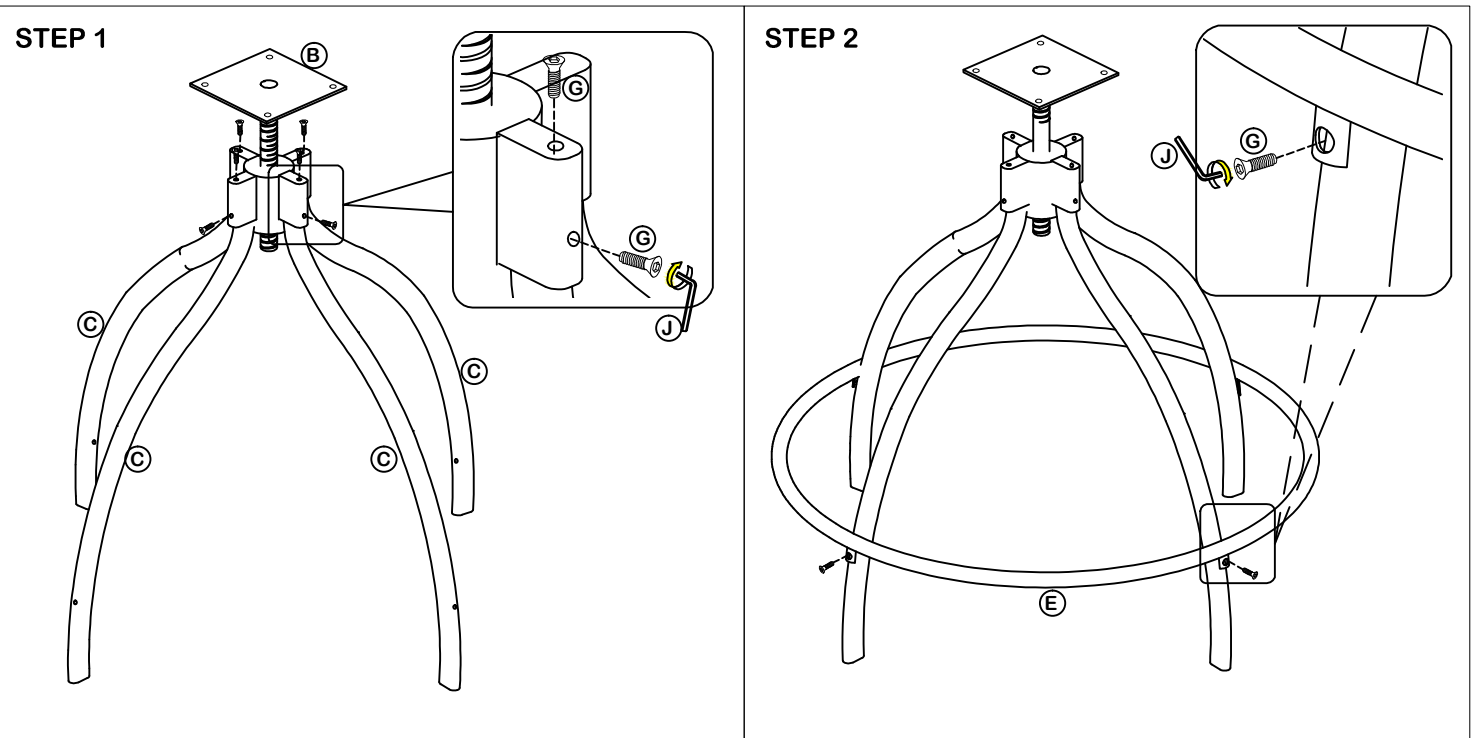

ASSEMBLY INSTRUCTIONS

STEP 3

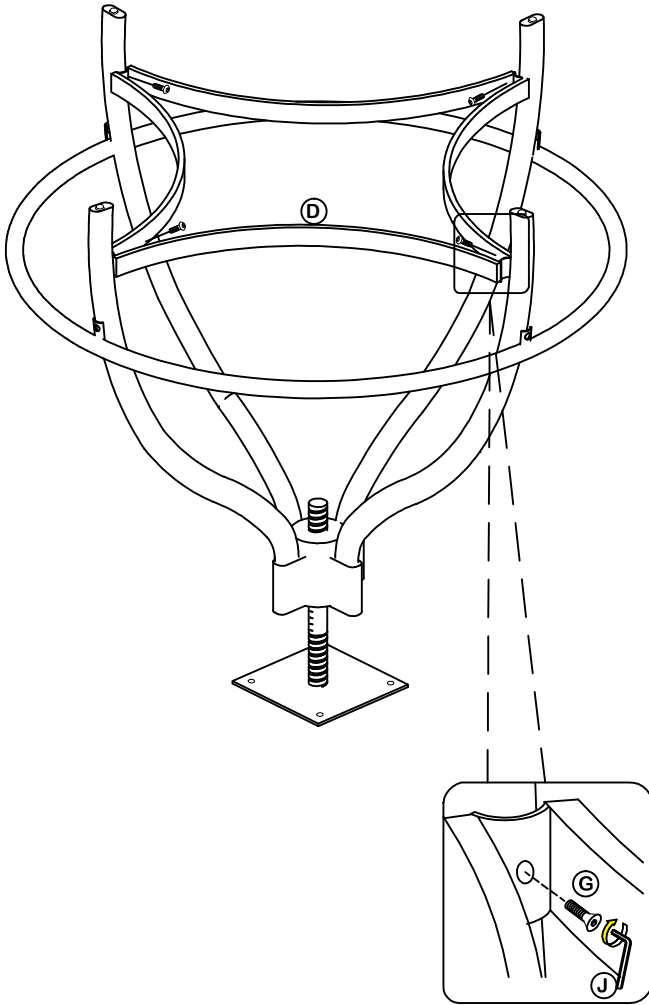

STEP 4

