

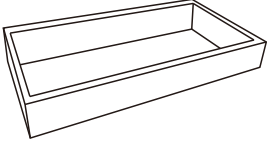

Assembly Instructions

		
A x 1 Left Seat	B x 1 Right Seat	C x 2 Arm
		
D x 2 Back Cushion	E x 2 Seat Cushion	F x 2 Pillow
		
G x 2 Back	H x 1 Back Cover	J x 16 Allen Bolt
		
K x 8 Allen Bolt	L x 24 Flat Washer	M x 1 Allen Wrench
		
N x 8 Leg		

Use (M,J,L) to connect to the Leg (N)
the Seat (A,B) as below.

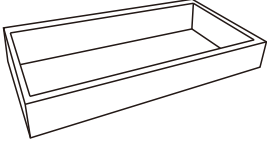
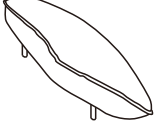
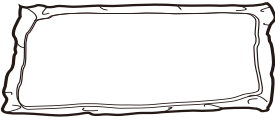
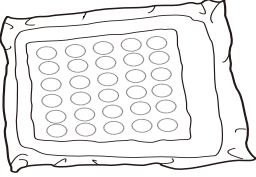
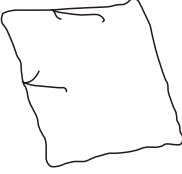
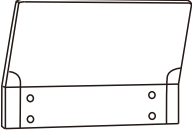
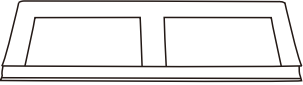
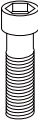

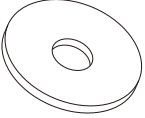
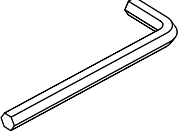
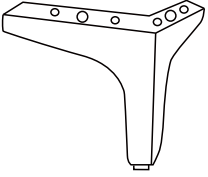
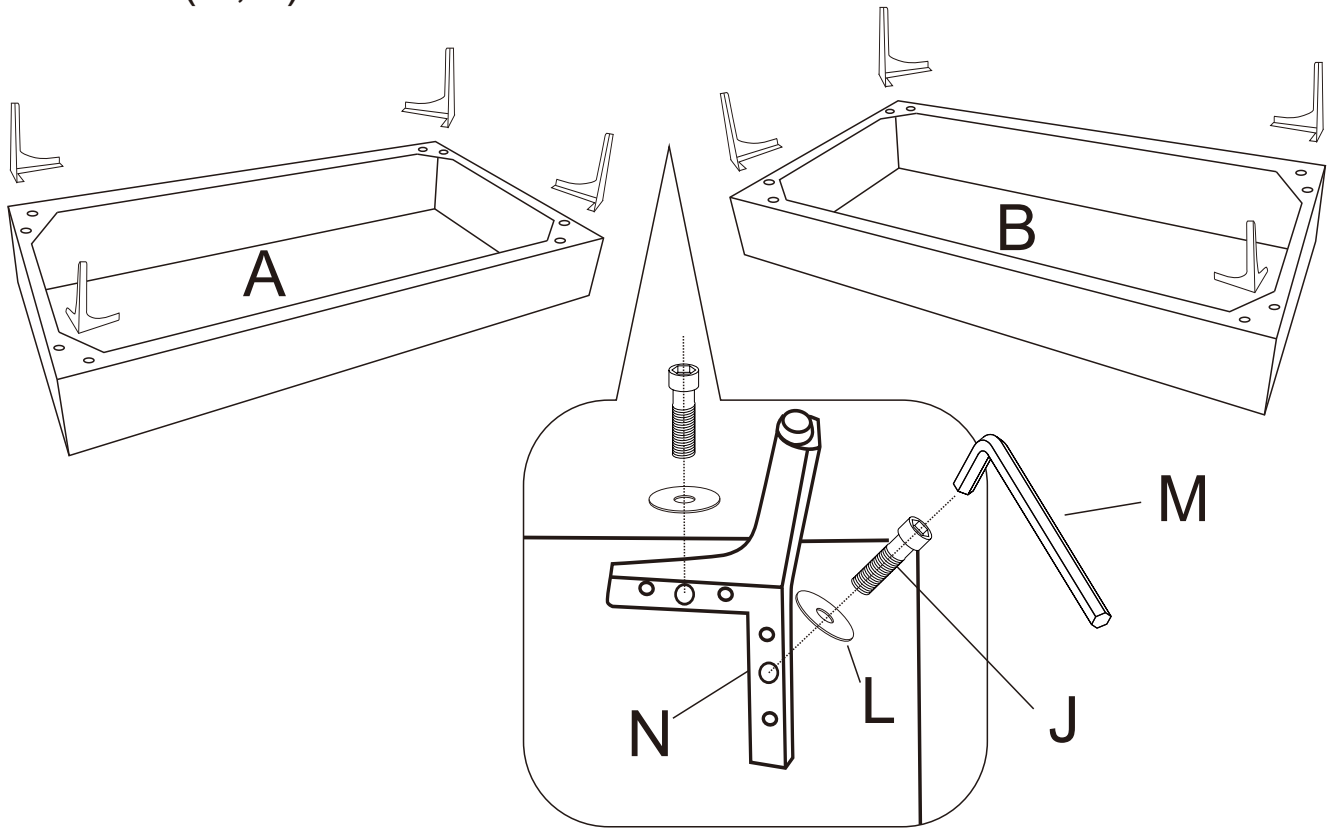
Hold (A, B) together.
Insert (C) into (A, B) seat

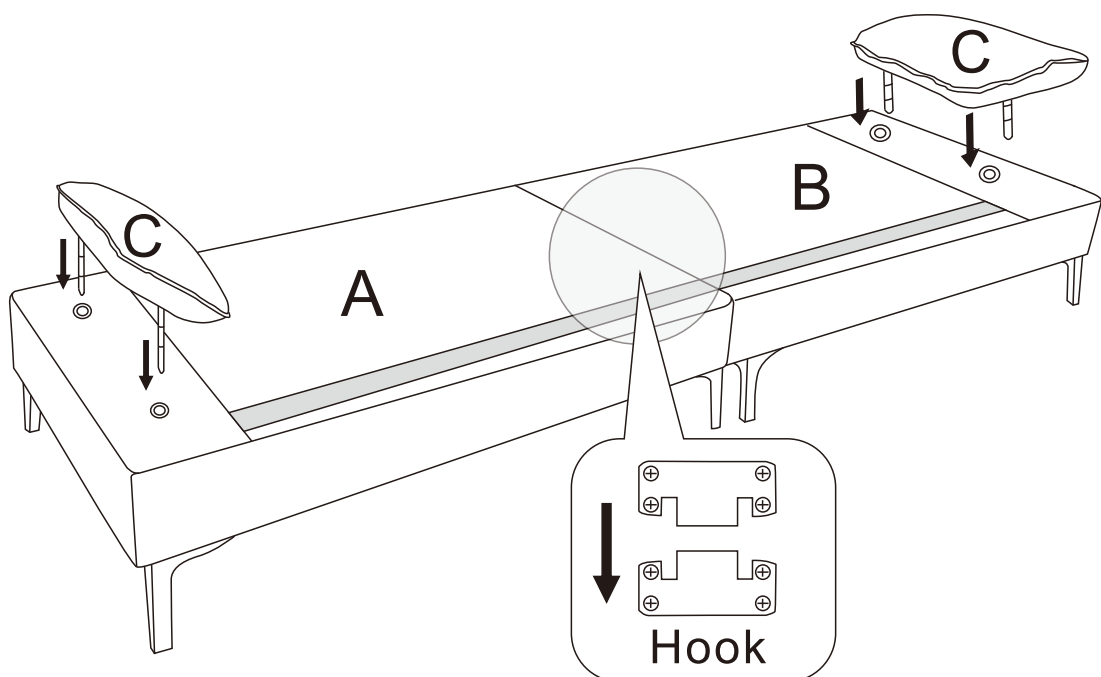

Use (M,K,L) to connect Back(G)to Sofa Seat (A,B)as below.

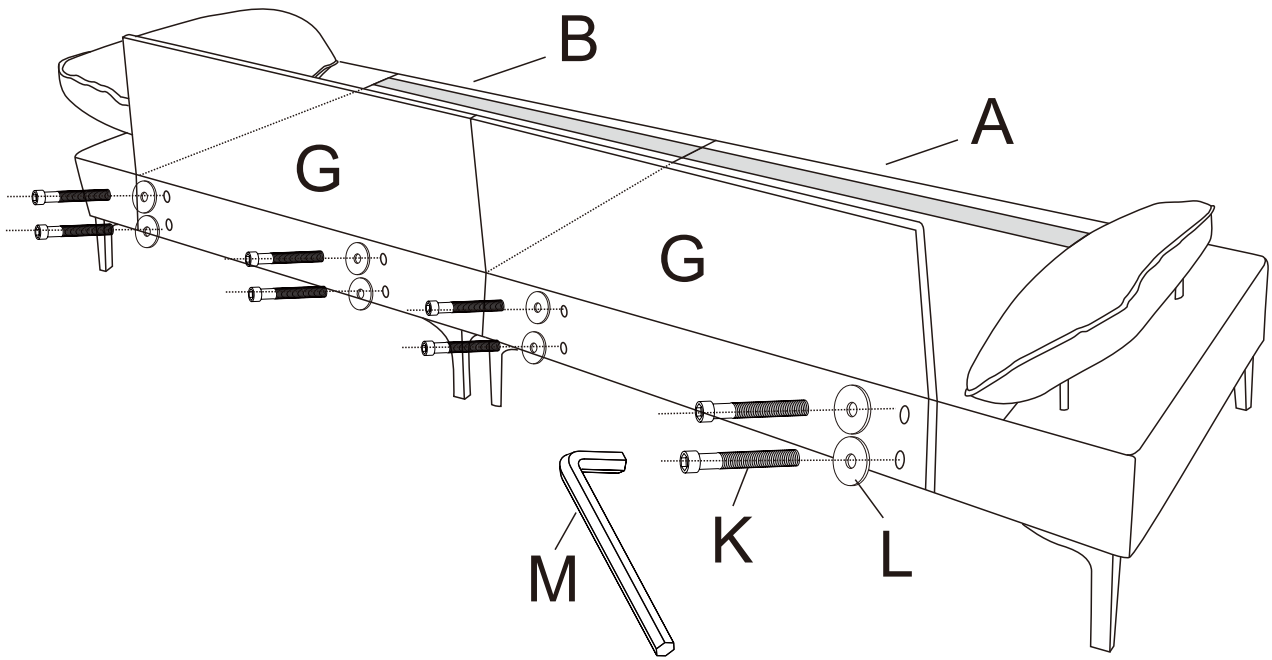

Put the Back Cover (H) on the back frame.

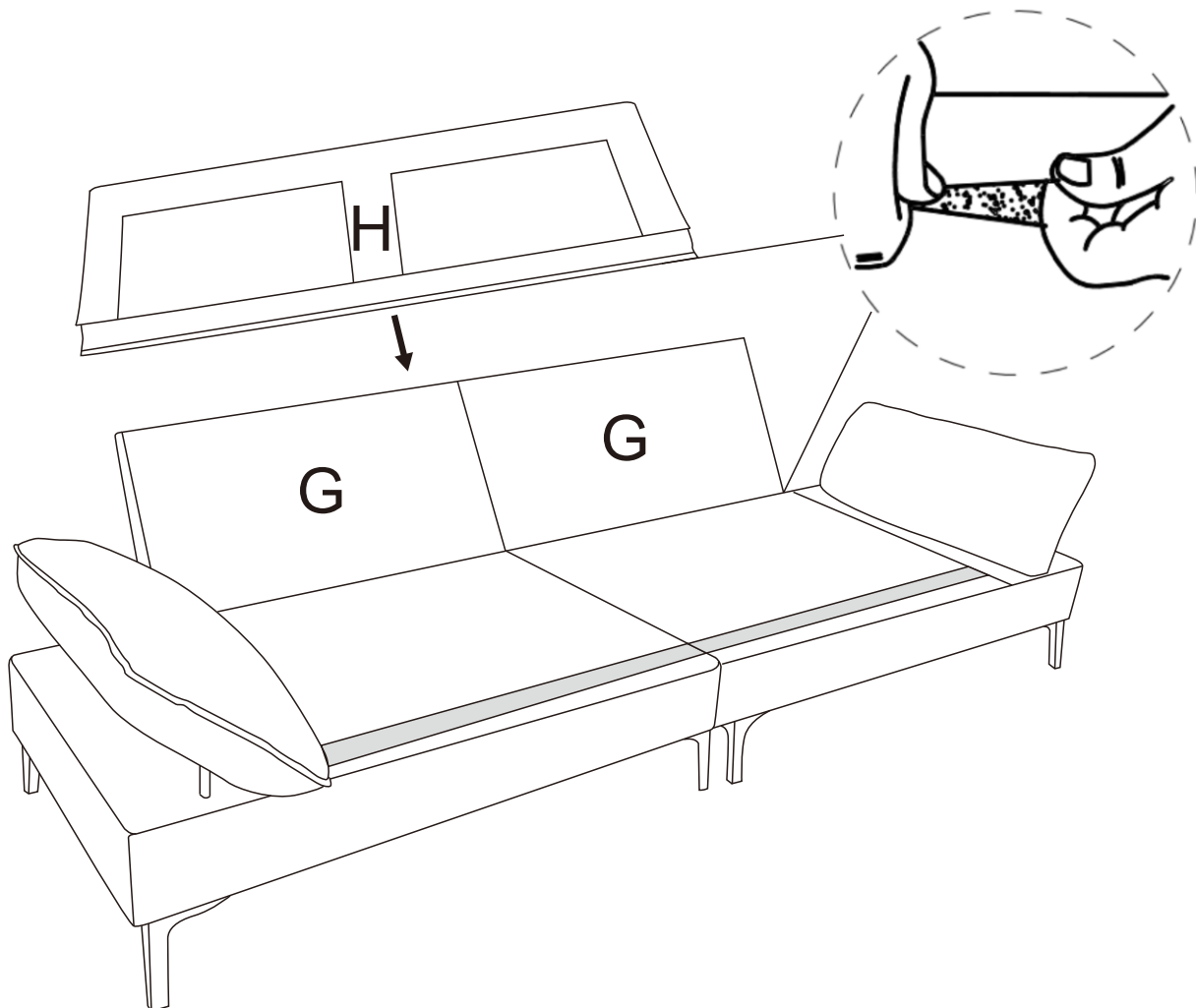

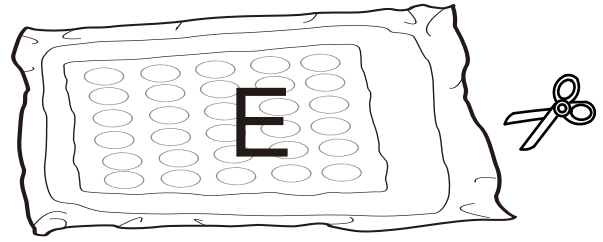
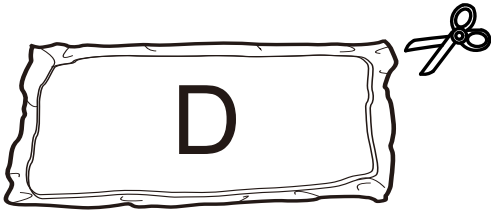

1. Pat to make it bounce better and fluff up.
2. Knead your cushion as if you were massaging it while letting air pass through the foam.



72h

It might takes up to 72 hours.

